



*USA OFFICE
Suite 202
364 Pennsylvania Avenue,
Glen Ellyn
Illinois 60137
USA
Tel +1 (630) 469 2981*

*UK OFFICE
14 Bentinck Court
Bentinck Road
West Drayton
UB7 7RQ
ENGLAND
Tel +44 (1895) 431421*

www.keymat.com

email: sales@keymat.com



Section 1. Table of Contents

<u>Section</u>	<u>Page</u>
<i>Section 1. Overview of Product Range.....</i>	<i>3</i>
<i>Section 2. Options.....</i>	<i>4</i>
<i>Section 3. Ratings and Performance , ADA Compliance.....</i>	<i>5</i>
<i>Section 4. Connectors and Connections.....</i>	<i>7</i>
<i>Matrix Keypad</i>	
<i>PS2 / USB Encoded Keypad</i>	
<i>PS2 / USB Cable Pinout</i>	
<i>Section 5. Configuration / Installation</i>	
<i>Final Assembly of Encryption Ready Keypad.....</i>	<i>9</i>
<i>Installation</i>	<i>10</i>
<i>Part Numbering Scheme</i>	<i>11</i>
<i>Ordering Details</i>	<i>12</i>
<i>Appendix 1</i>	<i>Layouts</i>
<i>Appendix 2</i>	<i>Panel Cutouts and Mounting Details</i>
<i>Appendix 3</i>	<i>Code Tables</i>

Section 2. Product Overview

Key Features / Specifications

- *Rugged, reliable and responsive data entry*
- *Vandal Resistant (20J BS EN 60068-2-75: 1997)*
- *Weather Resistant (IP65)*
- *Large buttons for clarity and ease of use*
- *Permanent, high contrast, laser engraved keytop graphics*
- *Raised tactile symbols on coloured function keys*
- *Raised "home pip" on the "5" key*
- *4 Row x 4 Column matrix circuit format*
- *Optional USB or PS2 encoded interface circuit (enclosed in water resistant pod)*
- *Optional PS2 or USB connection cable (supplied separately)*
- *Optional RS232 plug in module (supplied separately)*
- *Suitable for use by those with mobility or sensory impairment*
- *Overall dimensions: 124.0 mm x 118.5 mm x 17.5 mm (excluding interface pod on back face)*
- *UL approved*



Section 2. Options

	<i>Matrix Output</i>	<i>PS2 / USB Output</i>	<i>"Encryption Ready"</i>
Build Style			
<i>Vandal Resistant (stainless steel top plate)</i>	<input checked="" type="checkbox"/>	<input checked="" type="checkbox"/>	<input checked="" type="checkbox"/>
Keytops			
<i>Black Keytops laser marked white</i>	<input checked="" type="checkbox"/>	<input checked="" type="checkbox"/>	<input checked="" type="checkbox"/>
<i>Coloured Function Keys laser marked with black text</i>	<input checked="" type="checkbox"/>	<input checked="" type="checkbox"/>	<input checked="" type="checkbox"/>
Keypad Circuit			
<i>Matrix Output</i>	<input checked="" type="checkbox"/>		
<i>PS2 / USB Selectable Encoder</i>		<input checked="" type="checkbox"/>	
<i>Non-Encoded Keypad supplied with empty circuit pod (pod lid not fitted)</i>			<input checked="" type="checkbox"/>
Layout			
<i>UK Layout</i>	<input checked="" type="checkbox"/>	<input checked="" type="checkbox"/>	<input type="checkbox"/>
<i>USA Layout</i>	<input checked="" type="checkbox"/>	<input checked="" type="checkbox"/>	<input type="checkbox"/>
<i>Customer Specified</i>			<input checked="" type="checkbox"/>
Accessories			
<i>Cable with PS2 terminator</i>	<input type="checkbox"/>	<input checked="" type="checkbox"/>	
<i>Cable with USB terminator</i>	<input type="checkbox"/>	<input checked="" type="checkbox"/>	
<i>Underpanel Mounting Clips</i>	<input checked="" type="checkbox"/>	<input checked="" type="checkbox"/>	

Key : Available as standard Available as an option Not Available



6000 Series keypad for public environments Application / Engineering Manual

Section 3. Ratings and Performance

The 6000 Series keypad range is designed to meet the following requirements. Validation is by in-house test and additional third party assessment by an accredited test house, where appropriate. Storm 6000 Series keypads are a UL Recognized Component.

Matrix Keypad	PS2/USB Keypad	REFERENCE	RELATED BASIC STANDARD OR TEST METHOD
---------------	----------------	-----------	---------------------------------------

Electrical

EMC Emissions	N/A		EN55022 : 1998 Class B Limit *
			FCC CFR 47 Part 15 Class B *
EMC Immunity to ESD	N/A		EN55024 : 1998 EN 61000-4-2 :1995 ± 8kV Air ± 4kV Contact *
EMC Immunity to Radiated Fields	N/A		EN55024 : 1998 EN61000-4-3 :1996 *
Electrical Safety			EN60950, UL60950 UL Recognized Component E230121
Communication		Industry Standard PS2 or USB Interface	
Supply requirements – Voltage		+ 5V nominal (5.5 V to 4.75 V)	
Supply requirements – Current		20mA	
Key Switch Rating	+24V dc MAX 50mA MAX		
Anti Tamper Circuit Rating	+24V dc MAX 10mA MAX <500 Ohms (NORMALLY CLOSED)		

Environmental

Sealing – Water / Particulates		EN60529 (sealing to IP65)
Temperature		-20 °C to + 60 °C operating (dry)

Mechanical

Impact resistance		20 Joules via 50mm dia steel striker
Key pitch		20 mm General
Size		15 mm square
Travel		1.5mm nominal
Actuation force		130g nominal
Flammability of Major Plastic Parts		Keytops UL94 HB Moulding UL94 V-0 PCB UL94 V-0 Actuators UL94 HB

This document is provided for use and guidance of engineering personnel engaged in the installation or application of STORM data entry products manufactured by Keymat Technology Ltd. Please be advised that all information, data, and illustrations contained within this document remain the exclusive property of Keymat Technology Ltd. and are provided for the express and exclusive use as described above. This document is not supported by Keymat Technology's engineering change note, revision or reissue system. Data contained within this document is subject to periodic revision, reissue or withdrawal. Whilst every effort is made to ensure the information, data and illustrations are correct at the time of publication, Keymat Technology Ltd. are not responsible for any errors or omissions contained within this document.

The 6000 Series keypad range is designed to meet the requirements of existing and forthcoming Disability Access Requirements.

As international standards requirements are many and varied (although with some common themes for ATM Keypads), we have chosen the ADAAG requirements to illustrate compliance in the table below

	ADAAG Pt 707.4	6000 Series Keypad USA Layout
	Requirements for ATM Keypads	
Key Characteristics	<p>Key surfaces shall be raised above the surrounding surface by 1/25 inch (1 mm) minimum.</p> <p>The outer edge of key surfaces shall have a radius of 1/50 inch (0.5 mm) maximum.</p>	<p>Key surfaces are raised above the surrounding surface by 3mm</p> <p>Corner radii are 0.5mm</p>
Keypad Layout General	<p>707.4.4.1 Arrangement. Numeric keys shall be arranged in a 12-key telephone keypad layout with the number one key in the upper left hand corner.</p> <p>707.4.4.2 Marking. The number five key shall have a single raised dot.</p>	<p>Telephone Layout is used</p> <p>Number 5 key has a single raised feature.</p>
Key Separation	Any key surface shall be separated from other key surfaces by 1/8 inch (3.2 mm) minimum.	Minimum separation is 5mm
Separation from Function Keys	Function keys shall be separated from numeric keys by a distance that is not less than three times greater the distance between the numeric keys.	Separation to function keys is 15mm
Function Keys General	707.4.5.1 Arrangement. Function keys shall be arranged in the order of enter, clear, cancel, add value and decrease value horizontally from left to right or vertically from top to bottom. Where provided, add value and decrease value function keys shall be grouped with other function keys.	Order of function keys is Enter Clear Cancel
Function Keys Tactile Markings	707.4.5.2 Marking. Function keys shall be marked with tactile characters as follows: Enter or proceed key: raised circle; Clear or correct key: raised vertical line or bar; Cancel key: raised x; Add value key: raised plus sign; Decrease value key: raised minus sign.	Markings are Compliant (NB Add Value / Decrease Value not part of this layout)
Function Keys Colours	707.4.5.3 Colour Coding. Where function keys are colour coded, they shall be coloured as follows Cancel key: red; Clear or correct key: black; Enter or proceed key: green; Add value key: blue; Decrease value key: yellow.	All these colours are available. This layout has:- Cancel : Red Clear : Yellow Enter : Green (NB Canadian / European stds require Yellow for the Clear key, however layouts including Black key with raised Vertical bar is available to special order)

Section 4. Connectors and Connections - Matrix Output

The 6000 Series matrix keypad is supplied without a cable so that the user can select the correct cable length. Switches provide a momentary contact between designated connector pins. Pins are to suit Molex KK Type 0.1" Pitch Headers. The Connector Details below shows the orientation and position of the connector.

If RS232 output is required then the Storm 420 Series Encoder may be purchased separately - this plugs in directly to the rear of the keypad.

KEYPAD FRONT VIEW

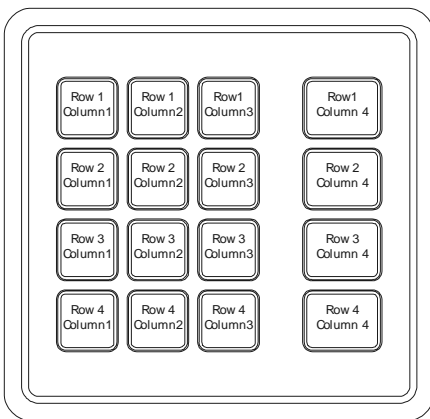

KEYPAD REAR VIEW

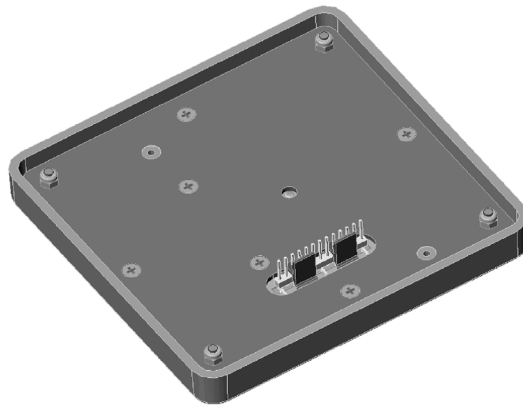

**CONTACT CONNECTIONS
(REAR VIEW)**

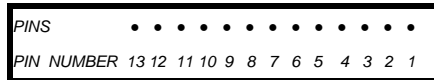

CONTACT MATRIX

PIN	ROW / COLUMN
1	NOT USED
2	TAMPER
3	R1
4	R2
5	C1
6	C2
7	C3
8	C4
9	R4
10	R3
11	NC
12	TAMPER
13	NOT USED

REAR VIEW with Storm 420 Series Encoder fitted

Installation Checklist - Keypad plus RS232

- ✓ Keypad
- ✓ Encoder, configuration switch set
- ✓ Panel Fixing prepared
- ✓ +5V regulated supply
- ✓ RS 232 cable with 6 way Molex KK socket
- ✓ 13 way ribbon cable keypad to encoder if encoder is to be remote from keypad
- ✓ Polarisng pins fitted to encoder

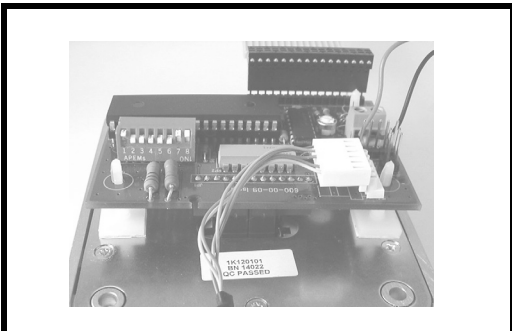

ANTI-TAMPER CIRCUIT

CONTACT	
OPERATING VOLTAGE	24V dc (max)
OPERATING CURRENT	10mA (max)
CIRCUIT RESISTANCE	<500 Ohms
(normally closed)	

This document is provided for use and guidance of engineering personnel engaged in the installation or application of STORM data entry products manufactured by Keymat Technology Ltd. Please be advised that all information, data, and illustrations contained within this document remain the exclusive property of Keymat Technology Ltd. and are provided for the express and exclusive use as described above. This document is not supported by Keymat Technology's engineering change note, revision or reissue system. Data contained within this document is subject to periodic revision, reissue or withdrawal. Whilst every effort is made to ensure the information, data and illustrations are correct at the time of publication, Keymat Technology Ltd. are not responsible for any errors or omissions contained within this document.

Section 4. Connectors and Connections - PS2/USB Output

The 6000 Series encoded keypad is supplied without a cable so that the user can select the correct cable length and connector type to suit their application. Cables are offered as separately purchased options, or alternatively the user can source their own cable to suit the application. The pinout details for the connectors are shown on the following page.

Option 1 PS2 Minidin connector, straight cable, 2.5 metres long

Option 2 USB connector, straight cable, 2.5 metres long

Fitting Cables

WARNING : THE FOLLOWING MUST BE DONE IN AN ESSD SAFE HANDLING AREA

In order to fit the cable, the pod cover on the back of the keypad must be removed. Plug the molex connector into the connector designated JP1 on the encoder pcb. Connect the earth tag to the securing nut and tighten. Set the positions of the USB / PS2 selector switches (see table below). Note that SW2 toggles the function key output codes between USA layout and UK layout. Ensure the grommet is correctly located into the slot in the pod; this provides strain relief and sealing. Close the pod cover.

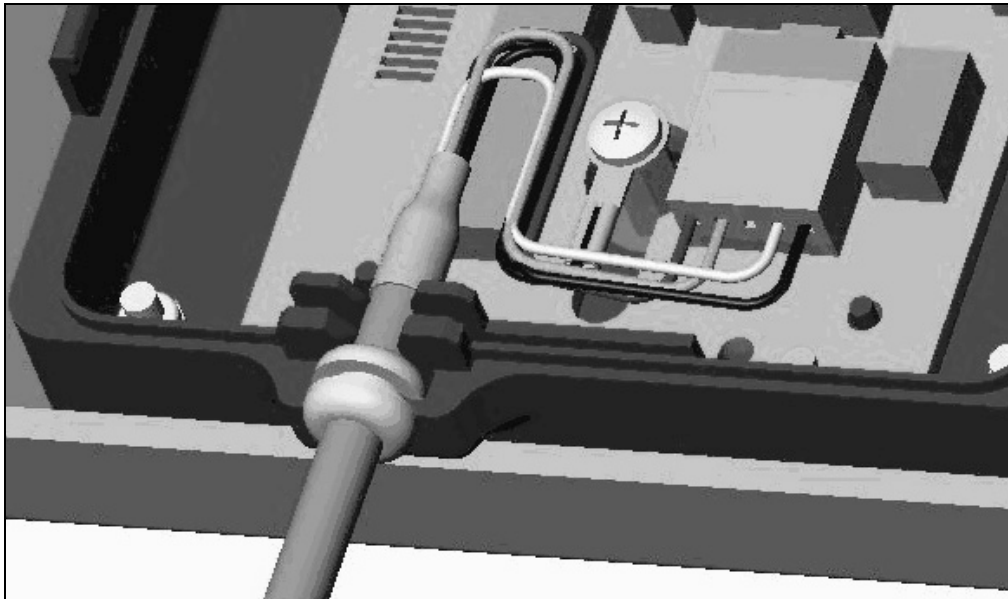

SWITCH SETTINGS	SW1	SW2	SW3
ON	USB	FUNCTION KEYS UK	USB
OFF	PS/2	FUNCTION KEYS USA	PS/2

Section 4. Connectors and Connections -PS2/USB Cable

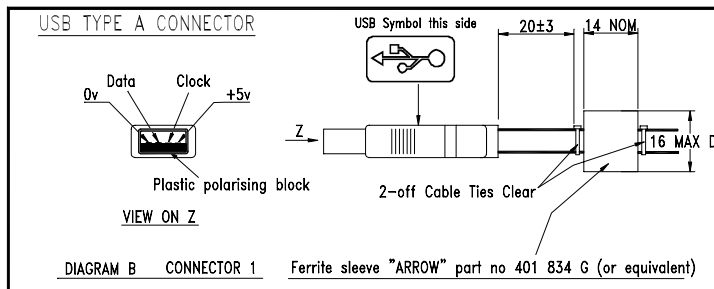
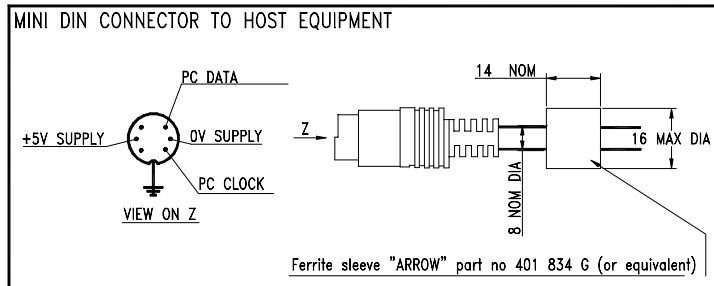
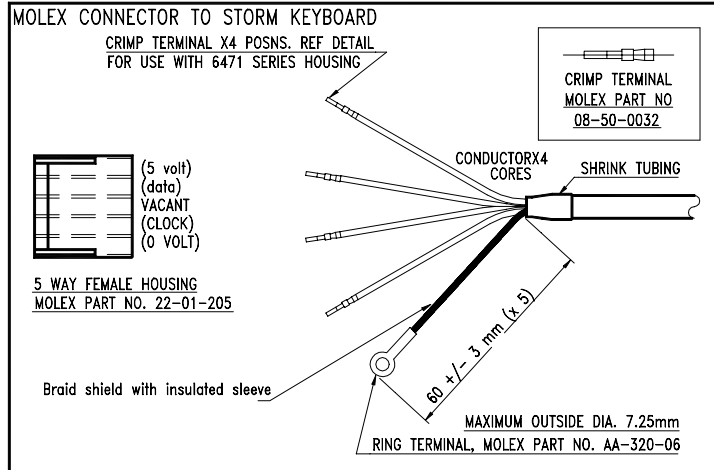

Section 5. Fitting Encryption Device (PCB) to “Encryption Ready” Keypad

“Encryption Ready” Keypads are supplied with a separate kit comprising a pod housing (base and lid), fixings, and the elastomeric connector. The customer supplies the encryption device (pcb) and cable. Assembly stages are as follows :-

1. Fit pod base assembly over the studs and secure with 2-off M3 nyloc nuts - Torque setting 70Ncm then fit 4-off M3 x 10mm plastite screws - Torque setting: 70 Ncm.
2. Place Zebra Strip into pod base.

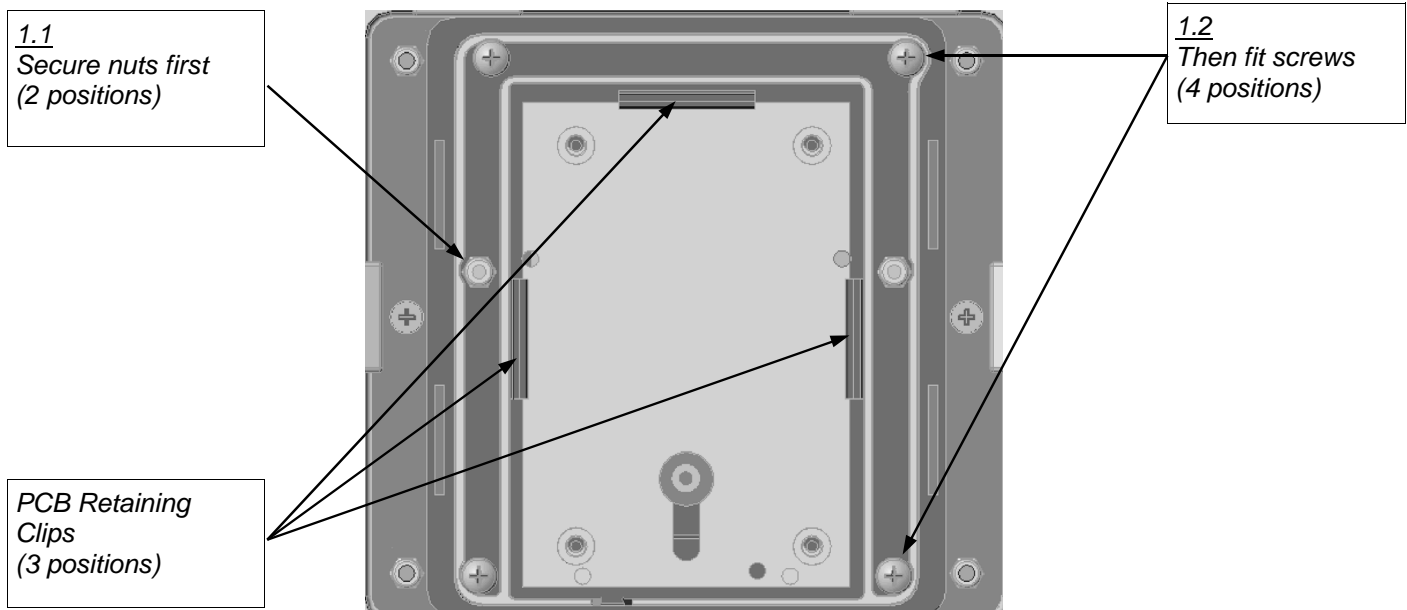

3. Fit (customer supplied) encoder assembly to pod base using the Jig to snap it into place. Take care not to bend the pcb retaining clips.
4. Fit (customer supplied) cable and test.
5. If specified, fit 4 off anti-tamper boot to the pod lid.
6. Clip pod lid onto the base.

Section 5. Installation

The 6000 Series keypad is designed to be secured with 6 panel mount clips and locknuts. The gasket is to be positioned between keypad and fixing panel prior to installation. Ensure that a suitable panel material is used to support the keypad. This must provide sufficient rigidity where sealing is required. (e.g. 1.6mm to 2.0mm steel). To optimise sealing the under side of the panel should be flat, clean & free of debris .

1)) Prepare a panel with 2mm weld studs and the appropriate cutout (see below)

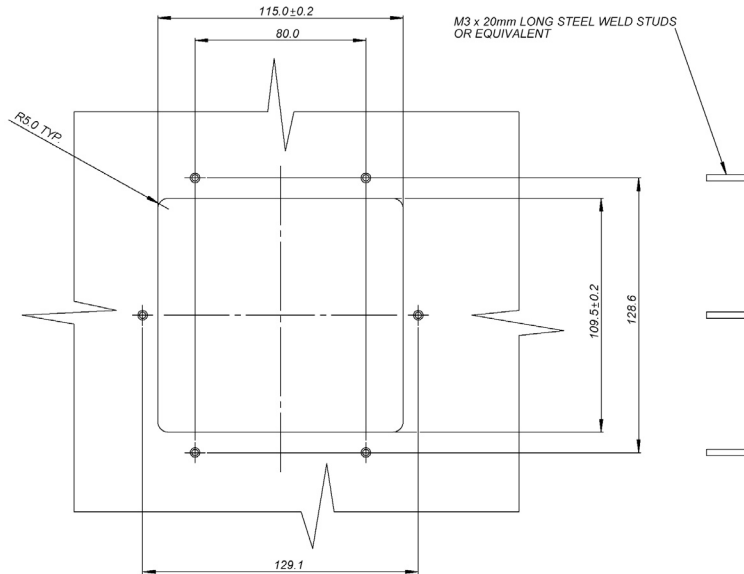

2) Fit the sealing gasket over the weld studs.

3) Offer up the keypad to the rear of the panel, and fit a mounting clip over each stud. Secure in place with locknuts. The torque applied to the locknuts should not exceed 25cN.m

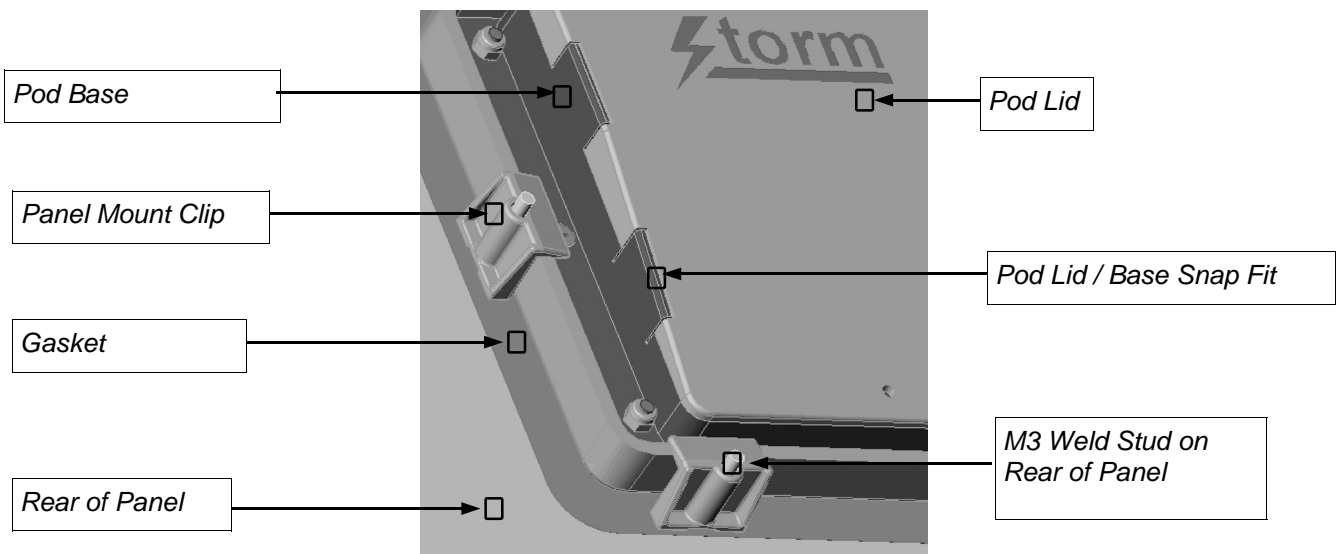

This document is provided for use and guidance of engineering personnel engaged in the installation or application of STORM data entry products manufactured by Keymat Technology Ltd. Please be advised that all information, data, and illustrations contained within this document remain the exclusive property of Keymat Technology Ltd. and are provided for the express and exclusive use as described above. This document is not supported by Keymat Technology's engineering change note, revision or reissue system. Data contained within this document is subject to periodic revision, reissue or withdrawal. Whilst every effort is made to ensure the information, data and illustrations are correct at the time of publication, Keymat Technology Ltd. are not responsible for any errors or omissions contained within this document.

Part Numbering Scheme

DIGIT 123	DIGIT 4	DIGIT 5	DIGIT 6	DIGIT 7	DIGIT 8	DIGIT 9	DIGIT 10
Range	Moulding/Top Plate	Keys	Encoder / Pod	Cable	Not Used	Layout	Distributor
600	0 St Steel top plate -		0 Zebra strip connection - customer fits own encoder	0 None	0	1 Storm Recommended ie UK	1 KT
		2 Black	1 Matrix output to 0.1" pins	1 2.5m PS2		2 ADA Compliant ie USA	2 RS
			2 Encoder fitted with user selectable PS2/USB	2 2.5m USB		3 Custom layout	3 USA
			3 PS2 and Clear Cover	3 1 m PS2			
			4 RS232 Encoder	4 2.5m RS232			
			5 Zebra strip connection - INCL ANTI TAMPER CIRCUIT customer fits own encoder				
			N				
			S				

Note - Customer Specific products are designated **_NS** (non-standard) in digits 5 and 6.

EXAMPLES	
6000-210011	6000 SERIES 16 WAY MATRIX KEYPAD, UK LAYOUT
6000-220011	6000 SERIES 16 WAY PS2/USB KEYPAD, NO CABLE, UK LAYOUT
6000-25NS01-0389	6000 SERIES 16 WAY ENCRYPTION READY KEYPAD, INP389 LAYOUT , INCL ENCODER POD HOUSING KIT



6000 Series keypad for public environments *Application / Engineering Manual*

Ordering Details

Stock No

Item

KEYPADS

6000-21001[x]	Keypad 6000 Series 16 way Matrix Output UK Layout
6000-21002[x]	Keypad 6000 Series 16 way Matrix Output USA Layout
6000-22001[x]	Keypad 6000 Series 16 way PS2 / USB, UK Layout
6000-22002[x]	Keypad 6000 Series 16 way PS2 / USB, USA Layout

ACCESSORIES

6000-MK00[x]	Mounting Clips Underpanel for 6000 Series
1200-00100[x]	Cable, 2.5m, PS/2 to 5 way Molex
1200-00200[x]	Cable, 2.5m, USB to 5 way Molex

RELATED PRODUCTS

4200-00[x]	Encoder 420 Series, RS232, No Cable, Plug-in (See Storm Application / Engineering Guide: 420 Series Encoder , for fixing and connection details)
------------	--

6000 Series Application/Engineering Manual - free download from www.keymat.com

[x] denotes packaging variant

Appendix 1: Layouts

FUNCTION KEY COLOURS	
CANCEL	RED
CLEAR	YELLOW
?	BLUE
ENTER	GREEN

UK Layout

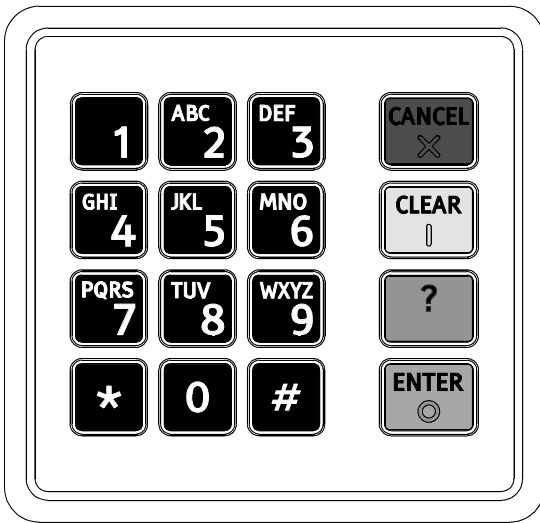

Other layouts are possible –see below.

Contact your Storm distributor for availability.

Alternative Layout - 13 Key

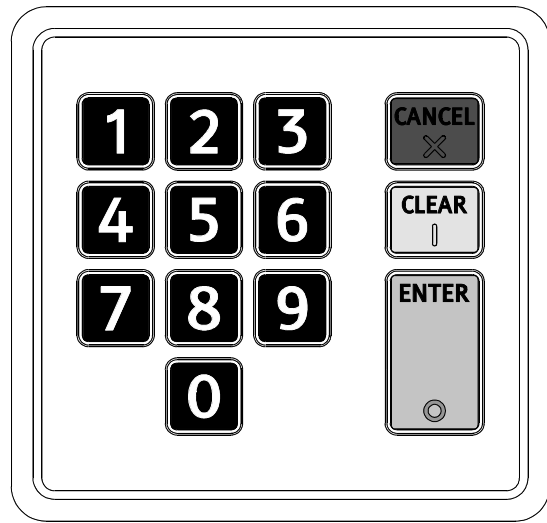

USA Layout

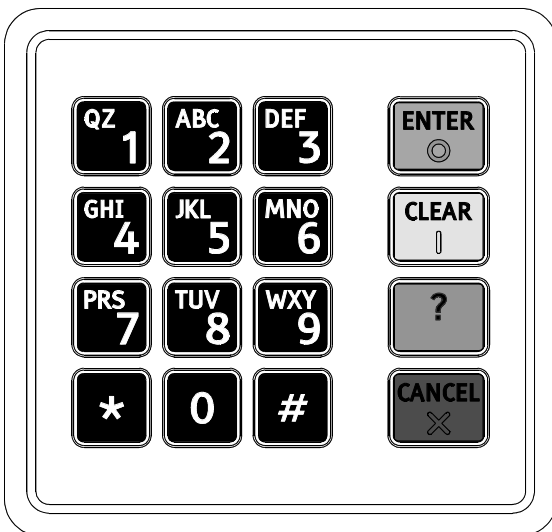

Alternative Layout - 15 Key

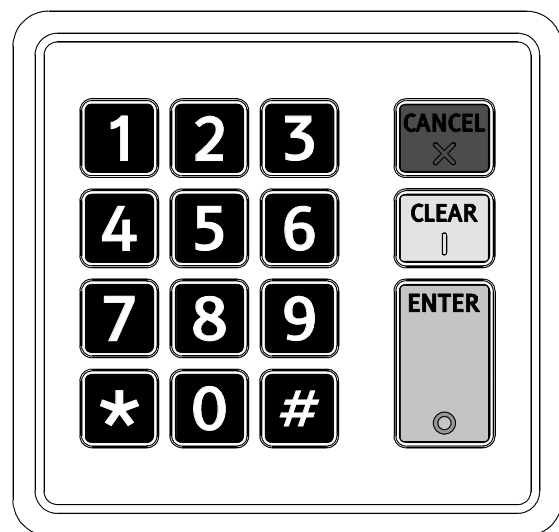

This document is provided for use and guidance of engineering personnel engaged in the installation or application of STORM data entry products manufactured by Keymat Technology Ltd. Please be advised that all information, data, and illustrations contained within this document remain the exclusive property of Keymat Technology Ltd. and are provided for the express and exclusive use as described above. This document is not supported by Keymat Technology's engineering change note, revision or reissue system. Data contained within this document is subject to periodic revision, reissue or withdrawal. Whilst every effort is made to ensure the information, data and illustrations are correct at the time of publication, Keymat Technology Ltd. are not responsible for any errors or omissions contained within this document.

Appendix 2. Dimensions and Mounting Details

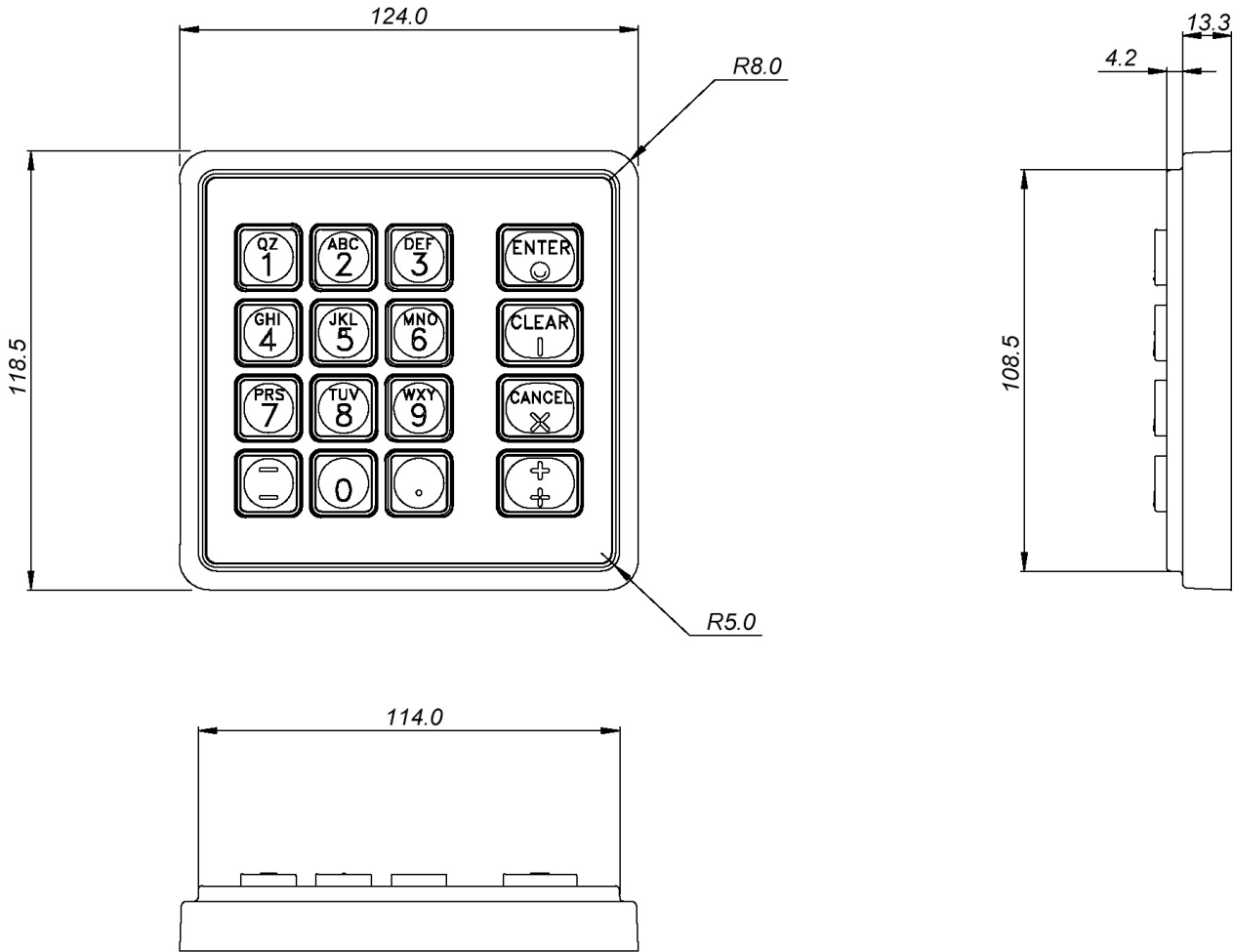

ASSEMBLY SHOWING BASIC SIZES.
 CUT OUT SIZE FOR UNDER PANEL MOUNT :-
 VERTICAL 109.5 ± 0.2 x HORIZONTAL 115.0 ± 0.2 x RADIUS 5.0mm

Appendix 3. Code Tables.

(NB : ASCII CODES ACHIEVED WITH 420 SERIES RS232 ENCODER FITTED)

Row / Column	UK Layout					USA Layout				
	Marking	Base Key	ASCII Code	PC/AT Code (Code Set 2)	USB Code	Marking	Base Key	ASCII Code	PC/AT Code (Code Set 2)	USB Code
R1C1	1	Black	31	69	59	1 QZ	Black	31	69	59
R1C2	2 ABC	Black	32	72	5A	2 ABC	Black	32	72	5A
R1C3	3 DEF	Black	33	7A	5B	3 DEF	Black	33	7A	5B
R1C4	CANCEL	Red with raised Cross	0D	76	29	ENTER	Green with raised circle	1B	5A	28
R2C1	4 GHI	Black	34	6B	5C	4 GHI	Black	34	6B	5C
R2C2	5 JKL	Black with Homepip	35	73	5D	5 JKL	Black with Homepip	35	73	5D
R2C3	6 MNO	Black	36	74	5E	6 MNO	Black	36	74	5E
R2C4	CLEAR	Yellow with raised vertical line	7F	66	2A	CLEAR	Yellow with raised vertical line	7F	66	2A
R3C1	7 PQRS	Black	37	6C	5F	7 PRS	Black	37	6C	5F
R3C2	8 TUV	Black	38	75	60	8 TUV	Black	38	75	60
R3C3	9 WXYZ	Black	39	7D	61	9 WXY	Black	39	7D	61
R3C4	?	Blue	05	05	3A	?	Blue	05	05	3A
R4C1	*	Black	2A	7C	55	*	Black	2A	7C	55
R4C2	0	Black	30	70	62	0	Black	30	70	62
R4C3	#	Black	23	5D	31	#	Black	23	12,26	E1,20
R4C4	ENTER	Green with raised circle	1B	5A	28	CANCEL	Red with raised Cross	0D	76	29
ANTI-TAMPER OPEN CIRCUIT			07*	NOT USED				07*	NOT USED	

* = CODE REPEATS EVERY 10 SECONDS WHILST CONDITION REMAINS ACTIVE.
TO RESET—DISCONNECT POWER FOR 30 SECONDS.

This document is provided for use and guidance of engineering personnel engaged in the installation or application of STORM data entry products manufactured by Keymat Technology Ltd. Please be advised that all information, data, and illustrations contained within this document remain the exclusive property of Keymat Technology Ltd. and are provided for the express and exclusive use as described above. This document is not supported by Keymat Technology's engineering change note, revision or reissue system. Data contained within this document is subject to periodic revision, reissue or withdrawal. Whilst every effort is made to ensure the information, data and illustrations are correct at the time of publication, Keymat Technology Ltd. are not responsible for any errors or omissions contained within this document.