

Silicon PIN Photodiode

Description

TEMD5020 is a high speed and high sensitive PIN photodiode. It is a miniature Surface Mount Device (SMD) including the chip with a 5.7 mm² sensitive area, detecting visible and near infrared radiation.

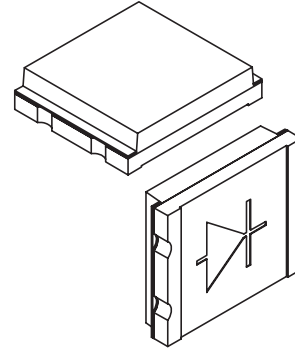

Features

- Radiant sensitive area ($A = 5.7 \text{ mm}^2$)
- Wide angle of half sensitivity $\varphi = \pm 65^\circ$
- High photo sensitivity for visible and near infrared radiation
- Fast response times
- Small junction capacitance
- Plastic package
- Floor life 72 h (MSL 4, acc. J-STD-20)
- Lead-free component
- Component in accordance to ELV 2000/53/EC, RoHS 2002/95/EC and WEEE 2002/96/EC



Applications

High speed photo detector

Absolute Maximum Ratings

$T_{\text{amb}} = 25^\circ\text{C}$, unless otherwise specified

Parameter	Test condition	Symbol	Value	Unit
Reverse Voltage		V_R	60	V
Power Dissipation	$T_{\text{amb}} \leq 25^\circ\text{C}$	P_V	215	mW
Junction Temperature		T_j	100	$^\circ\text{C}$
Operating Temperature Range		T_{amb}	- 40 to + 100	$^\circ\text{C}$
Storage Temperature Range		T_{stg}	- 40 to + 100	$^\circ\text{C}$
Soldering Temperature	$t \leq 3 \text{ s}$	T_{sd}	260	$^\circ\text{C}$
Thermal Resistance Junction/ Ambient		R_{thJA}	350	K/W

Electrical Characteristics

$T_{amb} = 25\text{ }^{\circ}\text{C}$, unless otherwise specified

Parameter	Test condition	Symbol	Min	Typ.	Max	Unit
Forward Voltage	$I_F = 50\text{ mA}$	V_F		1	1.3	V
Breakdown Voltage	$I_R = 100\text{ }\mu\text{A}$, $E = 0$	$V_{(BR)}$	60			V
Reverse Dark Current	$V_R = 10\text{ V}$, $E = 0$	I_{ro}		2	30	nA
Diode capacitance	$V_R = 0\text{ V}$, $f = 1\text{ MHz}$, $E = 0$	C_D		48		pF

Optical Characteristics

$T_{amb} = 25\text{ }^{\circ}\text{C}$, unless otherwise specified

Parameter	Test condition	Symbol	Min	Typ.	Max	Unit
Open Circuit Voltage	$E_e = 1\text{ mW/cm}^2$, $\lambda = 950\text{ nm}$	V_o		350		mV
Temp. Coefficient of V_o	$E_e = 1\text{ mW/cm}^2$, $\lambda = 950\text{ nm}$	TK_{V_o}		-2.6		mV/K
Short Circuit Current	$E_e = 1\text{ mW/cm}^2$, $\lambda = 950\text{ nm}$	I_k		32		μA
Temp. Coefficient of I_k	$E_e = 1\text{ mW/cm}^2$, $\lambda = 950\text{ nm}$	TK_{I_k}		0.1		%/K
Reverse Light Current	$E_e = 1\text{ mW/cm}^2$, $\lambda = 950\text{ nm}$, $V_R = 5\text{ V}$	I_{ra}	25	35		μA
Angle of Half Sensitivity		ϕ		± 65		deg
Wavelength of Peak Sensitivity		λ_p		900		nm
Range of Spectral Bandwidth		$\lambda_{0.5}$		600 to 1050		nm
Noise Equivalent Power	$V_R = 10\text{ V}$, $\lambda = 950\text{ nm}$	NEP		4×10^{-14}		W/ $\sqrt{\text{Hz}}$
Rise Time	$V_R = 10\text{ V}$, $R_L = 1\text{ k}\Omega$, $\lambda = 820\text{ nm}$	t_r		100		ns
Fall Time	$V_R = 10\text{ V}$, $R_L = 1\text{ k}\Omega$, $\lambda = 820\text{ nm}$	t_f		100		ns

Typical Characteristics ($T_{amb} = 25\text{ }^{\circ}\text{C}$ unless otherwise specified)

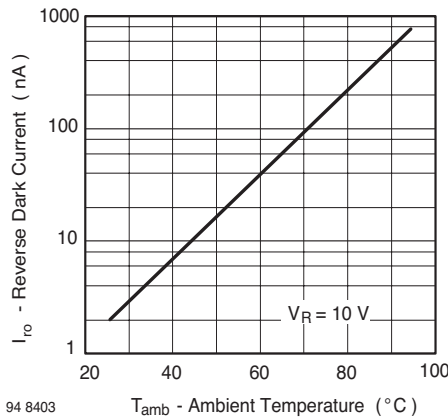

Figure 1. Reverse Dark Current vs. Ambient Temperature

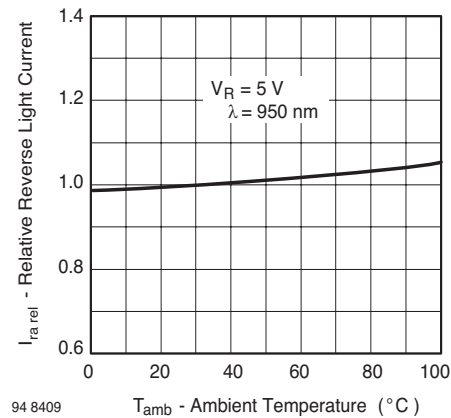

Figure 2. Relative Reverse Light Current vs. Ambient Temperature

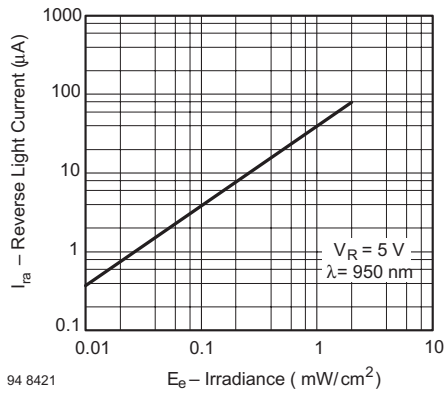

Figure 3. Reverse Light Current vs. Irradiance

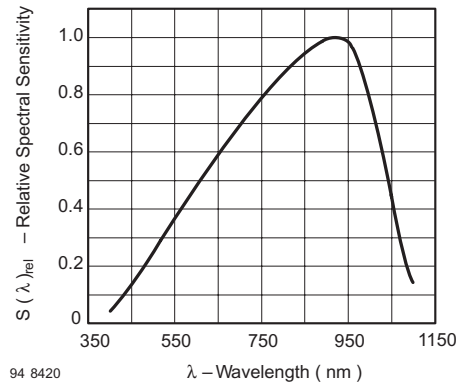

Figure 6. Relative Spectral Sensitivity vs. Wavelength

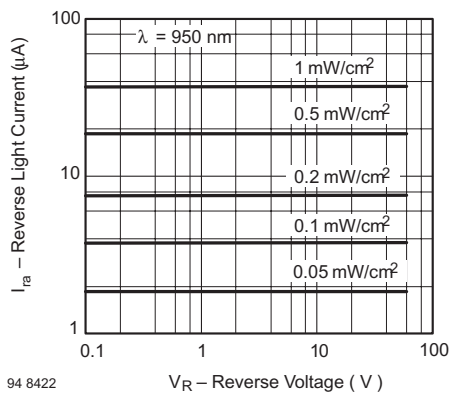

Figure 4. Reverse Light Current vs. Reverse Voltage

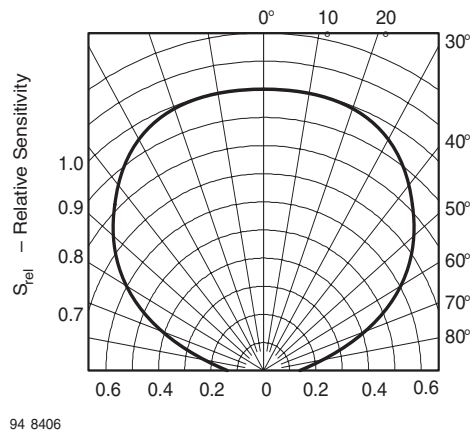

Figure 7. Relative Radiant Sensitivity vs. Angular Displacement

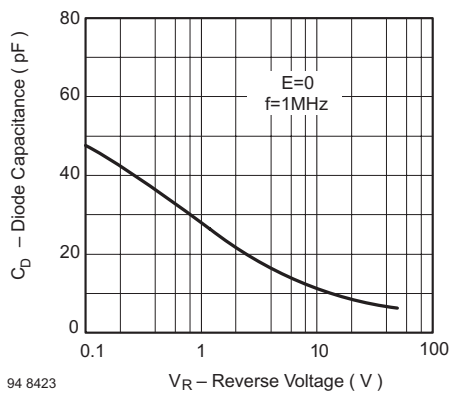
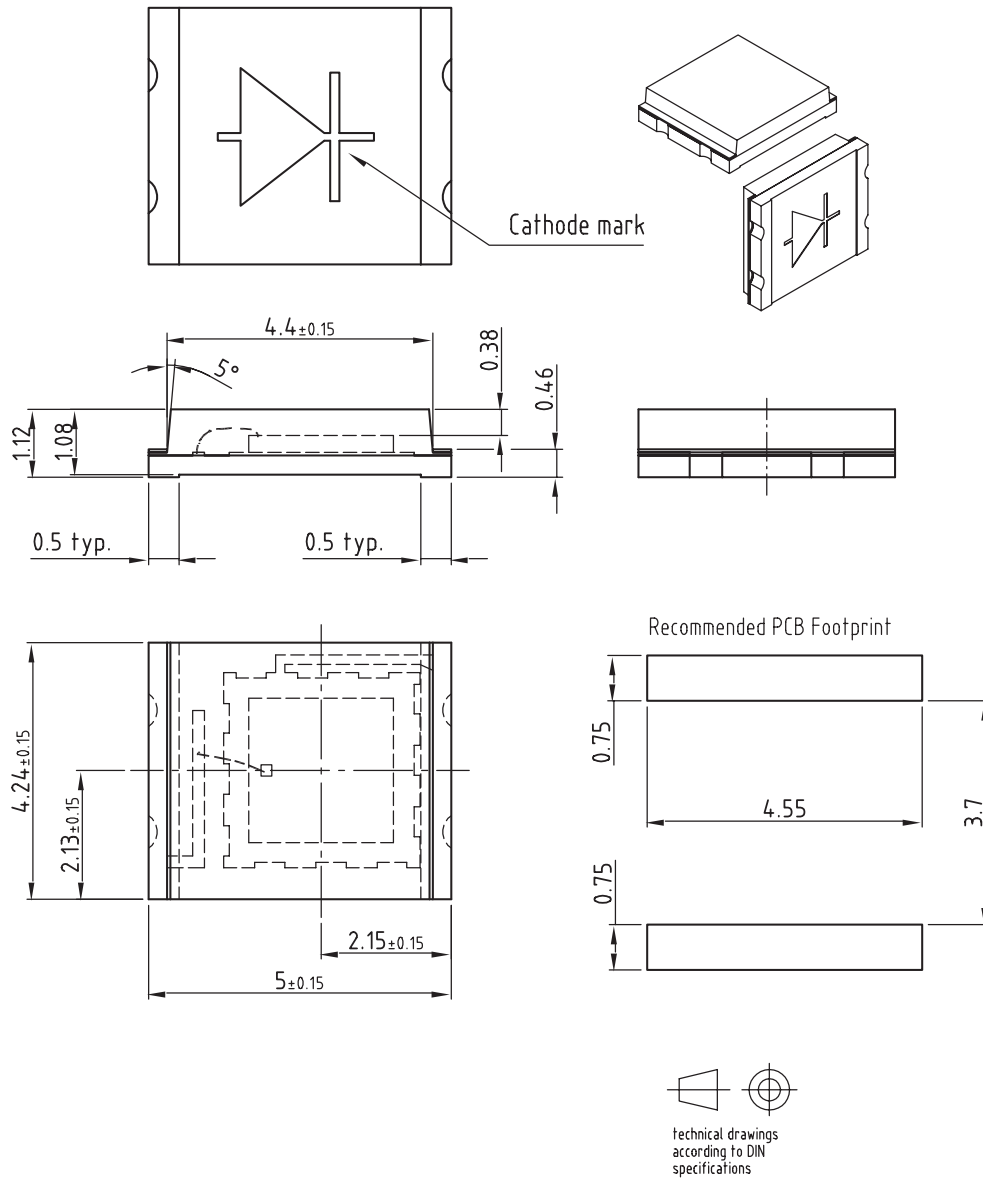

Figure 5. Diode Capacitance vs. Reverse Voltage

Package Dimensions in mm



Drawing-No.: 6.541-5059.01-4
Issue: 3; 13.12.04

All dimensions in mm
Not indicated tolerances ± 0.1

Taping

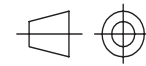
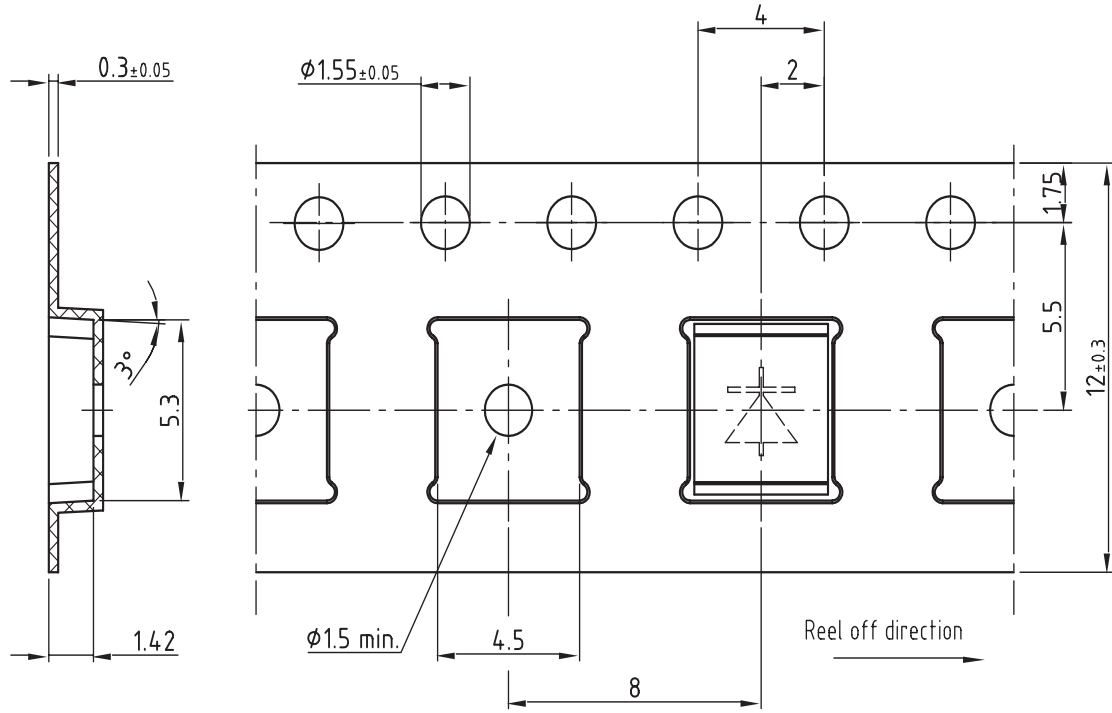

technical drawings
according to DIN
specifications

Not indicated tolerances ± 0.1

All dimensions in mm

Drawing-No.: 9.700-5293.01-4

Issue: 1; 03.12.04

Reflow Solder Profiles

Drying

In case of moisture absorption devices should be baked before soldering. Conditions see J-STD-020 or Label. Devices taped on reel dry using recommended conditions 192 h @ 40 °C (+ 5 °C), RH < 5 % or 96 h @ 60 °C (+ 5 °C), RH < 5 %

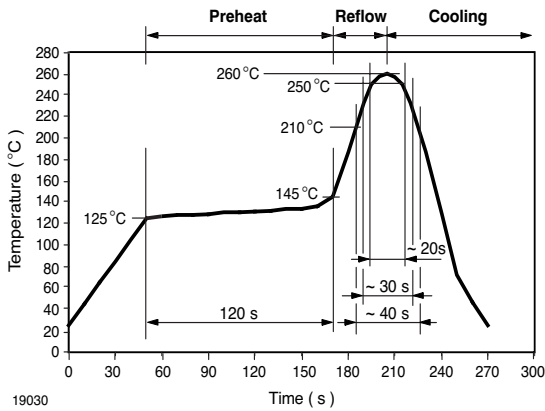

Figure 8. Lead-Free (Sn) Reflow Solder Profile

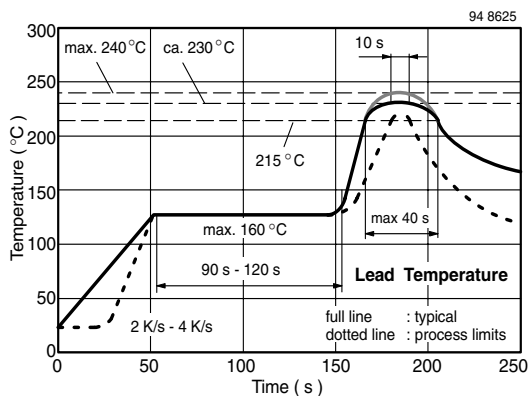

Figure 9. Lead Tin (SnPb) Reflow Solder Profile

Drypack

Devices are packed in moisture barrier bags (MBB) to prevent the products from moisture absorption during transportation and storage. Each bag contains a desiccant.

Floor Life

Floor life (time between soldering and removing from MBB) must not exceed the time indicated in J-STD-020. TEMD5110 is released for: Moisture Sensitivity Level 4, according to JEDEC, J-STD-020
 Floor Life: 72 h
 Conditions: $T_{amb} < 30\text{ °C}$, RH < 60 %

Ozone Depleting Substances Policy Statement

It is the policy of Vishay Semiconductor GmbH to

1. Meet all present and future national and international statutory requirements.
2. Regularly and continuously improve the performance of our products, processes, distribution and operating systems with respect to their impact on the health and safety of our employees and the public, as well as their impact on the environment.

It is particular concern to control or eliminate releases of those substances into the atmosphere which are known as ozone depleting substances (ODSs).

The Montreal Protocol (1987) and its London Amendments (1990) intend to severely restrict the use of ODSs and forbid their use within the next ten years. Various national and international initiatives are pressing for an earlier ban on these substances.

Vishay Semiconductor GmbH has been able to use its policy of continuous improvements to eliminate the use of ODSs listed in the following documents.

1. Annex A, B and list of transitional substances of the Montreal Protocol and the London Amendments respectively
2. Class I and II ozone depleting substances in the Clean Air Act Amendments of 1990 by the Environmental Protection Agency (EPA) in the USA
3. Council Decision 88/540/EEC and 91/690/EEC Annex A, B and C (transitional substances) respectively.

Vishay Semiconductor GmbH can certify that our semiconductors are not manufactured with ozone depleting substances and do not contain such substances.

We reserve the right to make changes to improve technical design and may do so without further notice.

Parameters can vary in different applications. All operating parameters must be validated for each customer application by the customer. Should the buyer use Vishay Semiconductors products for any unintended or unauthorized application, the buyer shall indemnify Vishay Semiconductors against all claims, costs, damages, and expenses, arising out of, directly or indirectly, any claim of personal damage, injury or death associated with such unintended or unauthorized use.

Vishay Semiconductor GmbH, P.O.B. 3535, D-74025 Heilbronn, Germany
Telephone: 49 (0)7131 67 2831, Fax number: 49 (0)7131 67 2423