

Product Description

The TQ3131 is a 3V, RF LNA IC designed specifically for Cellular band CDMA/AMPS applications. It's RF performance meets the requirements of products designed to the IS-95 and AMPS standards. The TQ3131 is designed to be used with the TQ5131 (CDMA/AMPS mixer) which provides a complete CDMA receiver for 800MHz dual-mode phones.

The LNA incorporates on-chip switches which determine CDMA, AMPS, and bypass mode select. When used with the TQ5131 (CDMA RFA/mixer), four gain states are available. The RF output port is internally matched to 50 Ω , greatly simplifying the design and keeping the number of external components to a minimum. The TQ3131 achieves good RF performance with low current consumption, supporting long standby times in portable applications. Coupled with the very small SOT23-8 package, the part is ideally suited for Cellular band mobile phones.

Electrical Specifications¹

| Parameter | Min | Typ | Max | Units |
|---------------------------------------|-----|------|-----|-------|
| Frequency | 832 | | 894 | MHz |
| Gain | | 13.0 | | dB |
| Noise Figure | | 1.4 | | dB |
| Input 3 rd Order Intercept | | 10.0 | | dBm |
| DC supply Current | | 10.5 | | mA |

Note 1: Test Conditions: Vdd=2.8V, Tc=25C, RF frequency=881MHz, CDMA High Gain state.

TQ3131

DATA SHEET

3V Cellular Band CDMA/AMPS LNA IC

Features

- Small size: SOT23-8
- Single 3V operation
- Low-current operation
- Gain Select
- Mode Select
- High IP3 performance
- Few external components

Applications

- IS-95 CDMA Mobile Phones
- AMPS Mobile Phones
- Dual Mode CDMA Cellular applications
- 832-870MHz CDMA applications

TQ3131

Data Sheet

Electrical Characteristics

| Parameter | Conditions | Min. | Typ/Nom | Max. | Units |
|---|------------|------|---------|------|-------|
| RF Frequency | | 832 | 881 | 894 | MHz |
| CDMA Mode-High Gain | | | | | |
| Gain | | 11.5 | 13.0 | | dB |
| Noise Figure | | | 1.4 | 2.0 | dB |
| Input IP3 | | 8.0 | 10.0 | | dBm |
| LNA IN Return Loss (with external matching) | | 10 | | | dB |
| LNA OUT Return Loss | | 10 | | | dB |
| Supply Current | | | 10.5 | 13.5 | mA |
| Bypass Mode | | | | | |
| Gain | | -3.0 | -2.0 | | dB |
| Noise Figure | | | 2.0 | 3.0 | dB |
| Input IP3 | | 18.0 | 30.0 | | dBm |
| LNA IN Return Loss (with external matching) | | 10 | | | dB |
| LNA OUT Return Loss | | 10 | | | dB |
| Supply Current | | | 1.2 | 2.5 | mA |
| AMPS Mode | | | | | |
| Gain | | 8.5 | 11.0 | | dB |
| Noise Figure | | | 1.6 | 2.2 | dB |
| Input IP3 | | 2.0 | 3.0 | | dBm |
| LNA IN Return Loss (with external matching) | | 10 | | | dB |
| LNA OUT Return Loss | | 10 | | | dB |
| Supply Current | | | 4.0 | 5.5 | mA |
| Supply Voltage | | 2.7 | 2.8 | 3.3 | V |

Note 1: Test Conditions: $V_{dd}=2.8V$, $RF=881MHz$, $T_c = 25^\circ C$, unless otherwise specified.

Note 2: Min/Max limits are at $+25^\circ C$ case temperature, unless otherwise specified.

Absolute Maximum Ratings

| Parameter | Value | Units |
|--------------------------------|------------|-------|
| DC Power Supply | 5.0 | V |
| Power Dissipation | 500 | mW |
| Operating Temperature | -40 to 85 | C |
| Storage Temperature | -60 to 150 | C |
| Signal level on inputs/outputs | +20 | dBm |
| Voltage to any non supply pin | +0.3 | V |

Typical Performance

Test Conditions, unless Otherwise Specified: Vdd=2.8V, Tc=+25C, RF=881MHz

CDMA High Gain Mode
Gain v Freq v Temp

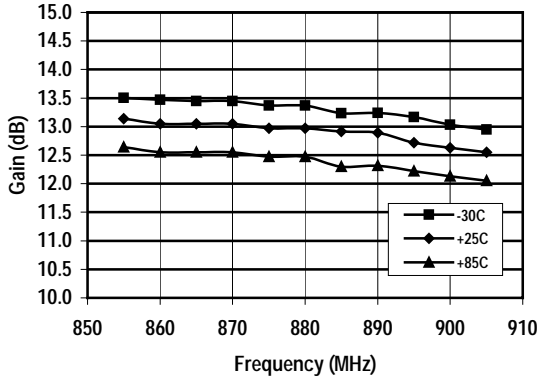

CDMA High Gain Mode
Idd v Vdd v Temp

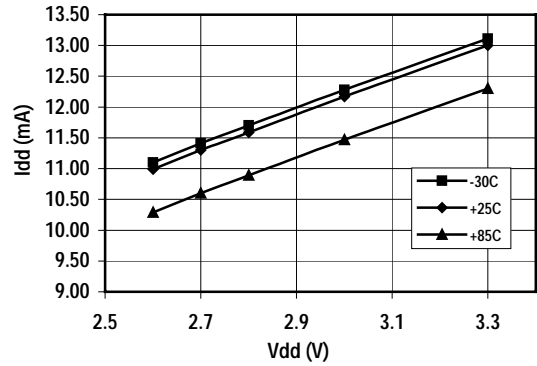

CDMA High Gain Mode
IIP3 v Freq v Temp

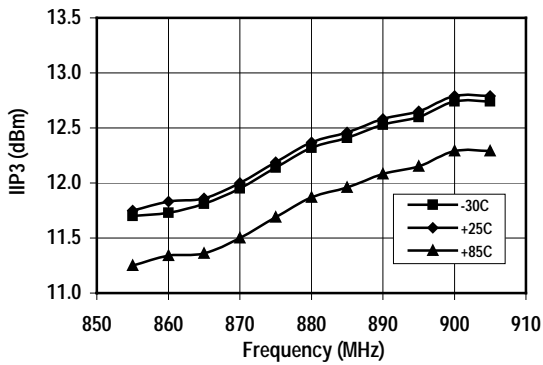

AMPS Mode
Gain v Freq v Temp

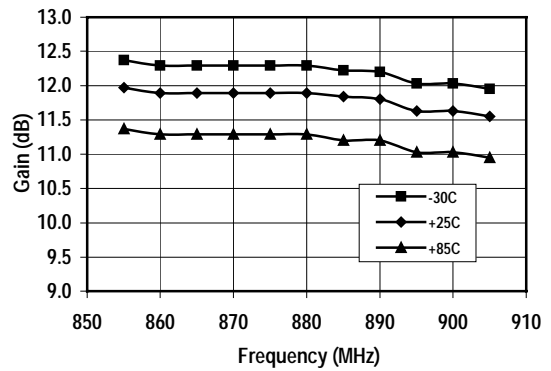

CDMA High Gain Mode
Noise Figure v Freq v Temp

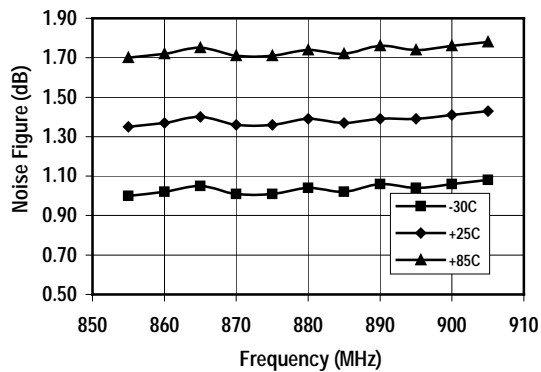

AMPS Mode
IIP3 v Freq v Temp

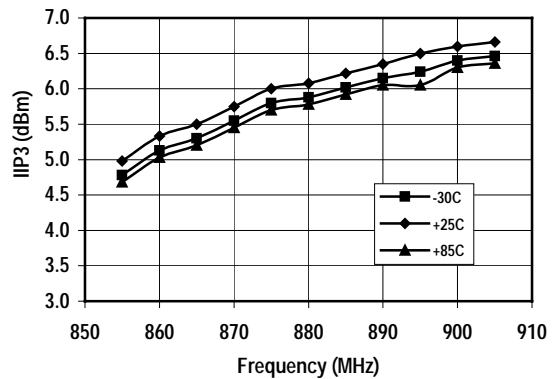

TQ3131

Data Sheet

AMPS Mode
Noise Figure v Freq v Temp

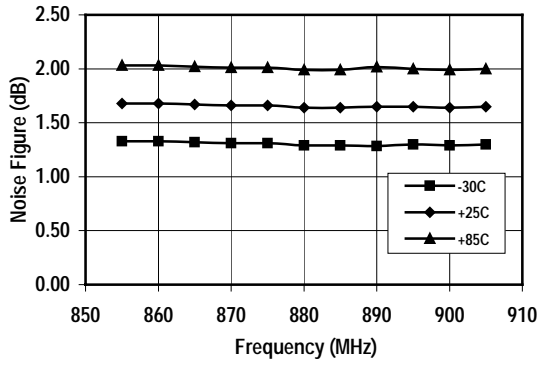

BYPASS Mode
Gain v Freq v Temp

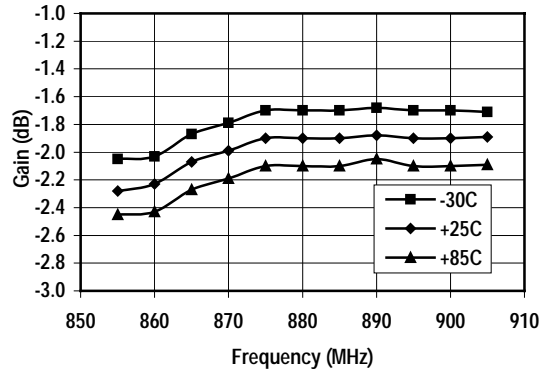

AMPS Mode
Idd v Vdd v Temp

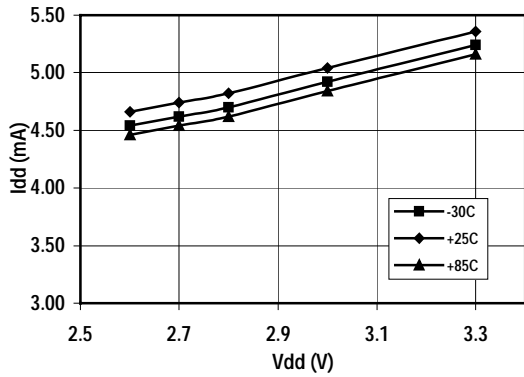

BYPASS Mode
Noise Figure v Freq v Temp

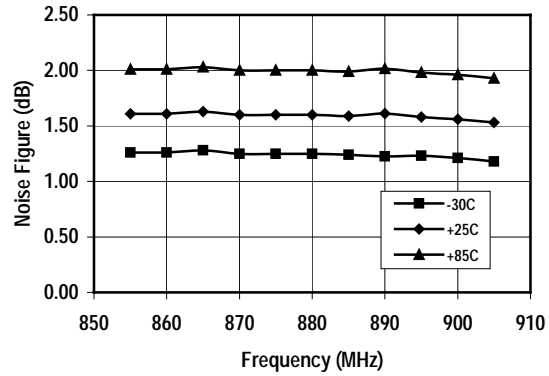

BYPASS Mode
IIP3 v Freq v Temp

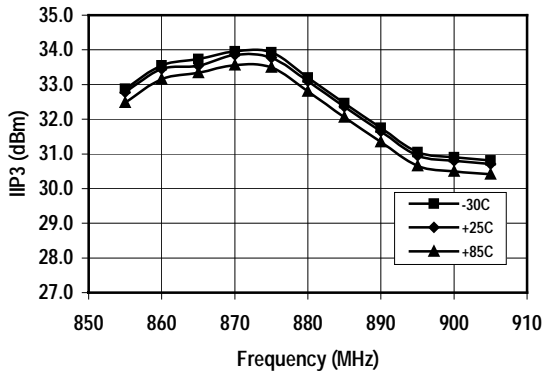

BYPASS Mode
Idd v Vdd v Temp

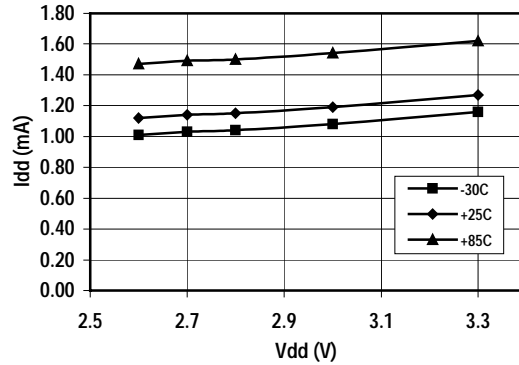

Application/Test Circuit

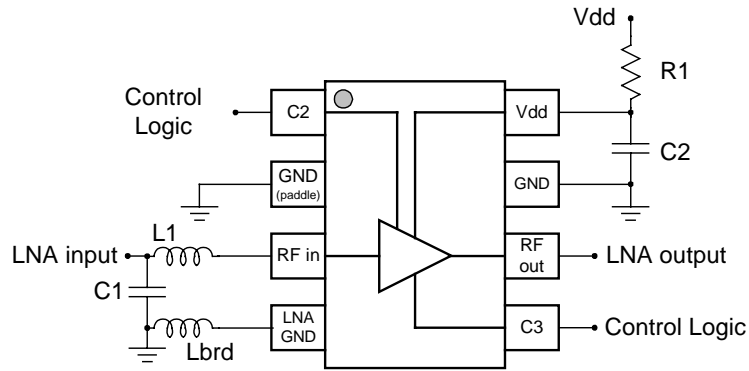

Bill of Material for TQ3131 LNA Application/Test Circuit

| Component | Reference Designator | Part Number | Value | Size | Manufacturer |
|-------------|----------------------|-------------|----------------------|---------|------------------------|
| Receiver IC | U1 | TQ3131 | | SOT23-8 | TriQuint Semiconductor |
| Capacitor | C1 | | 3.3pFd | 0402 | |
| Capacitor | C2 | | 8.2pF | 0402 | |
| Resistor | R1 | | 3.3Ω | 0402 | |
| Inductor | L1 | | 15nH | 0402 | |
| Inductor | Lbrd | | See application note | | |

TQ3131

Data Sheet

TQ3131 Product Description

The TQ3131 LNA uses a cascode low noise amplifier, along with signal path switching. A bias control circuit sets the quiescent current for each mode and ensures peak performance over process and temperature, (refer to Figure 1). In the application, CMOS level signals are applied to pins 1 and 5 and are decoded by internal logic in order to set the device to the desired mode. (see Table 1 for logic control states)

In the high gain mode, switches S1, S2, and S5 are closed, with switches S3 and S4 open. In the bypass mode, switches S1, S2, and S5 are open, with switches S3 and S4 closed. Having five switches ensures that there are no parasitic feedback paths for the signal. In the AMPS mode, control logic switches the LNA into a low current bias condition.

Only three external components are needed in an application. The chip uses an external cap and inductor for the input match to pin 3. The output is internally matched to 50 ohms at pin 6. A Vdd bypass cap is required close to pin 8.

External degeneration of the cascode is required between pin 4 and ground. However, a small amount of pc board trace can be used as the inductor (Lbrd). Alternatively, if an extra component can be tolerated, a small value chip inductor can be used. (see Figure 2)

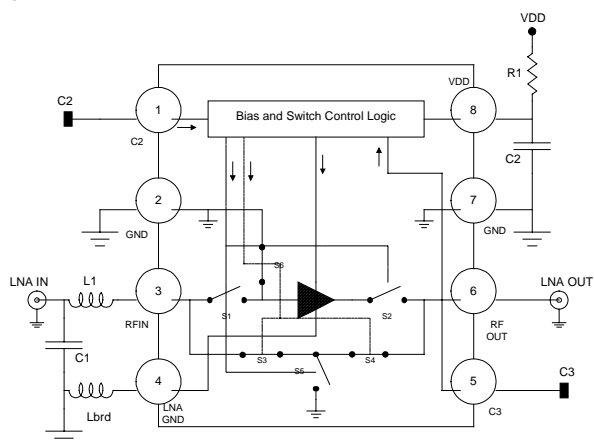

Figure 1 TQ3131 Simplified Schematic

Operation

| MODE | C2 | C3 | Typical Gain |
|-----------|----|----|--------------|
| High Gain | 0 | 0 | 13(dB) |
| | 1 | 0 | |
| AMPS | 0 | 1 | 11(dB) |
| Bypass | 1 | 1 | -2(dB) |

Table 1 LNA States and Control Bits

LNA Input Network Design

Input network design for most LNA's is a straightforward compromise between noise figure and gain. The TQ3131 is no exception, even though it has 3 different modes. The device was designed so that one only needs to optimize the input match in the high gain mode. As long as the proper grounding and source inductance are used, the other two modes will perform well with the same match.

It is probably wise to synthesize the matching network component values for some intermediate range of Gamma values, and then by experimentation, find the one which provides the best compromise between noise figure and gain. The quality of the chip ground will have some effect on the match, which is why some experimentation will likely be needed. The input match will affect the output match to some degree, so S22 should be monitored.

The values used on our evaluation board may be used as a starting point.

Noise Parameter Analysis

A noise parameter analysis is shown on the next page for both the high gain and AMPS modes. A "nominal" device was mounted directly on a solid copper ground plane with semi-rigid probes attached to the device input and output pins. A value of Lbrd was chosen so that 13.0dB of gain was attained at conjugate match. Then the tuner was removed and noise data was taken. Please note that although data was taken at 700MHz and 1000MHz, the device was designed to operate satisfactorily only over a much more limited range.

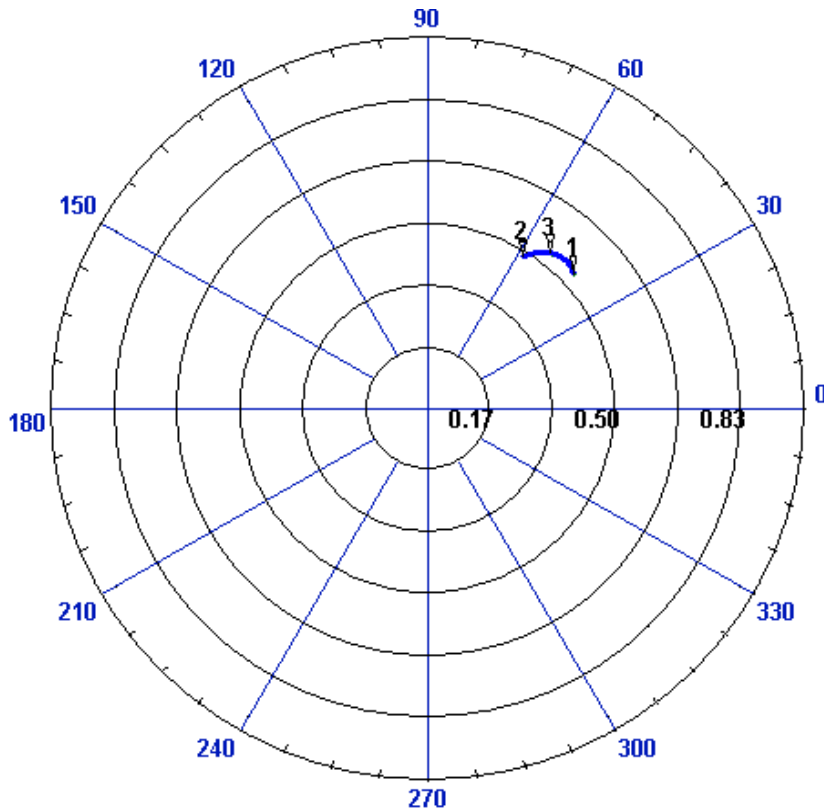

| |
|------------|
| M1= 0.530 |
| P1= 43.314 |
| 0.700GHz |
| M2= 0.480 |
| P2= 58.485 |
| 1.000GHz |
| M3= 0.530 |
| P3= 52.399 |
| 0.880GHz |

Gamma Opt analysis for TQ3131 High Gain Mode

| Freq (MHz) | Γ Opt | Γ Angle | Fmin (dB) | R noise |
|------------|--------------|----------------|-----------|---------|
| 700 | 0.53 | 43.3 | 0.90 | 18.5 |
| 880 | 0.53 | 52.4 | 0.92 | 16.5 |
| 1000 | 0.48 | 58.5 | 1.01 | 15.4 |

TQ3131 Data Sheet

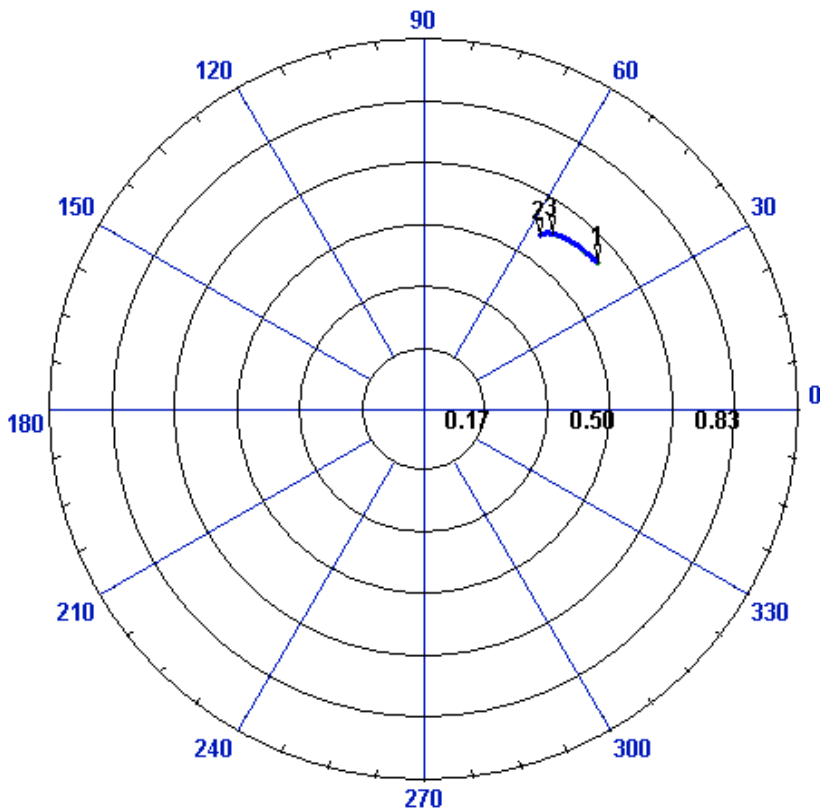

| |
|------------|
| M1= 0.610 |
| P1= 40.601 |
| 0.700GHz |
| M2= 0.560 |
| P2= 56.602 |
| 1.000GHz |
| M3= 0.586 |
| P3= 54.223 |
| 0.880GHz |

Gamma Opt analysis for TQ3131 Amps Mode

| Freq (MHz) | Γ Opt | Γ Angle | Fmin (dB) | R noise |
|------------|--------------|----------------|-----------|---------|
| 700 | 0.61 | 40.6 | 1.22 | 33.0 |
| 880 | 0.70 | 54.2 | 1.09 | 27.4 |
| 1000 | 0.56 | 56.6 | 1.42 | 27.0 |

Gain Control via Pin 4 Inductance

The source connection of the LNA cascode is brought out separately through pin 4. That allows the designer to make some range of gain adjustment. The total amount of inductance present at the source of the cascode is equal to the bond wire plus package plus external inductance. One should generally use an external inductance such that gain in the high gain CDMA mode = 13.0. Although it is possible to increase the gain of the TQ3131 by using little or no degeneration, input intercept will be degraded.

Figure 2 shows how a spiral pc board trace can be used as the external inductance. It is suggested that such a circuit be used for the initial design prototype. Then the optimum inductance can be found by simply solder bridging across the inductor. The final pc board design can then include the proper shorted version of the inductor.

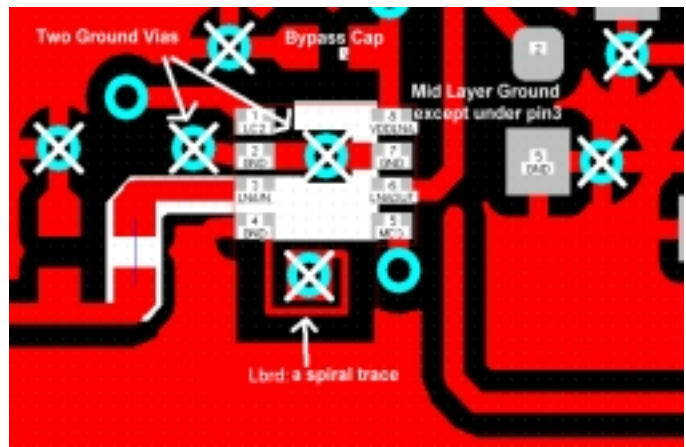

Figure 2 Showing Lbrd and Grounding on Evaluation Board

Selection of the Vdd Bypass Cap for Optimum

Performance

The Vdd bypass capacitor has the largest effect on the LNA output match, and is required for proper operation. Because the input match affects the output match to some degree as well, the process of picking the bypass cap value involves some iteration. First, an input match is selected which gives adequate gain and noise figure. Then the bypass capacitor is varied to give the best output match. Generally, the poorer the chip grounding, the smaller the bypass capacitor value will be. The demo board achieves 11-12dB of return loss which is adequate for connection directly to the input of a SAW filter.

Grounding

An optimal ground for the device is important in order to achieve datasheet specified performance.

Symptoms of a poor ground include reduced gain and the inability to achieve >2:1 VSWR at the output when the input is matched. It is recommended to use multiple vias to a mid ground plane layer. The vias at pins 2 and 7 to this layer should be as close to the lead pads as possible. Additionally, the ground return on the Vdd bypass cap should provide minimal inductance back to chip pins 2 and 7.

TQ3131 S-Parameters

Following are S-Parameter graphs for both the high gain and the AMPS modes. Data was taken on a single "nominal" device at 2.8v Vdd. The reference planes were set at the end of the package pins. Note that the plots are almost identical for both modes.

TQ3131 High Gain Mode S-Parameters S11

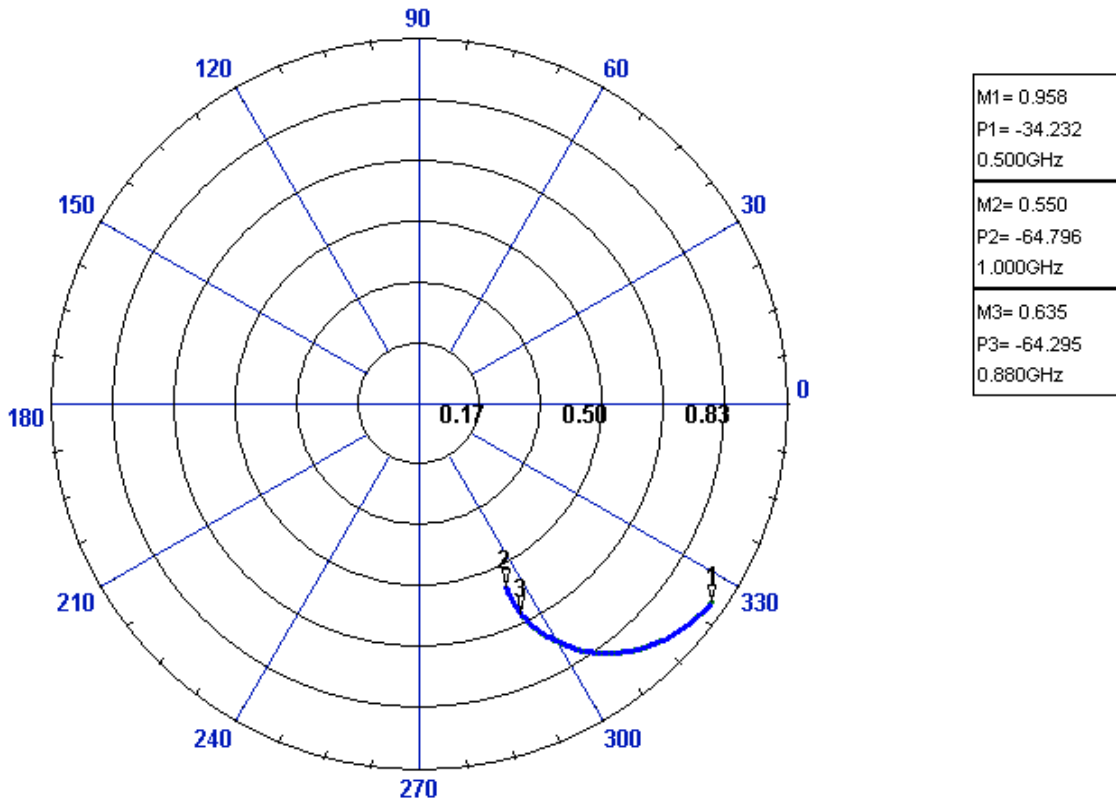

TQ3131
Data Sheet

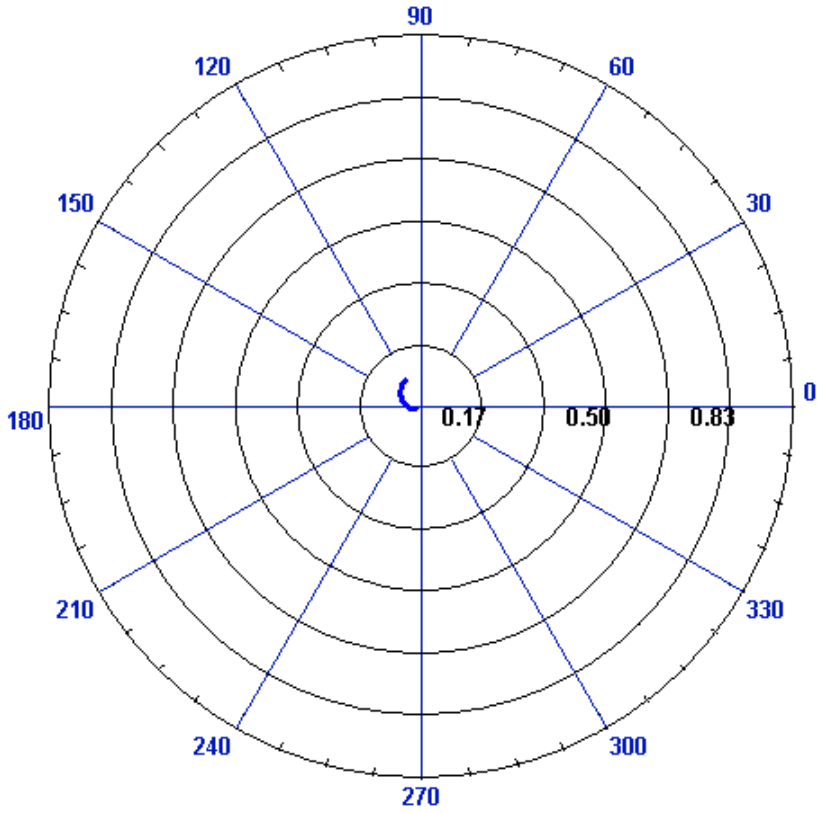

S12

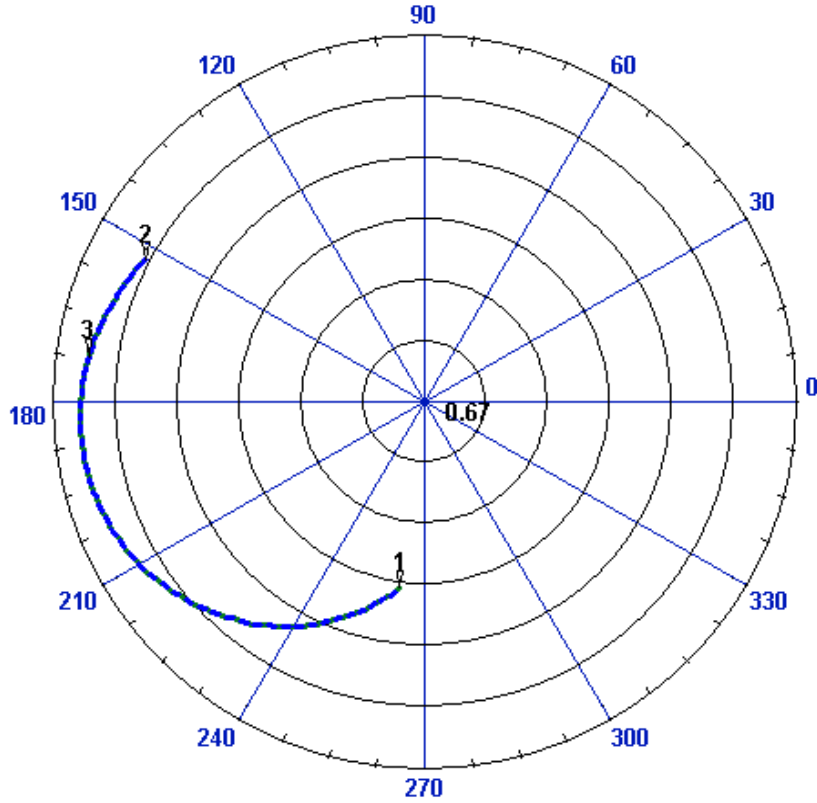

| |
|-------------|
| M1= 2.042 |
| P1= -97.643 |
| 0.500GHz |
| M2= 3.368 |
| P2= 152.711 |
| 1.000GHz |
| M3= 3.641 |
| P3= 172.179 |
| 0.680GHz |

S21

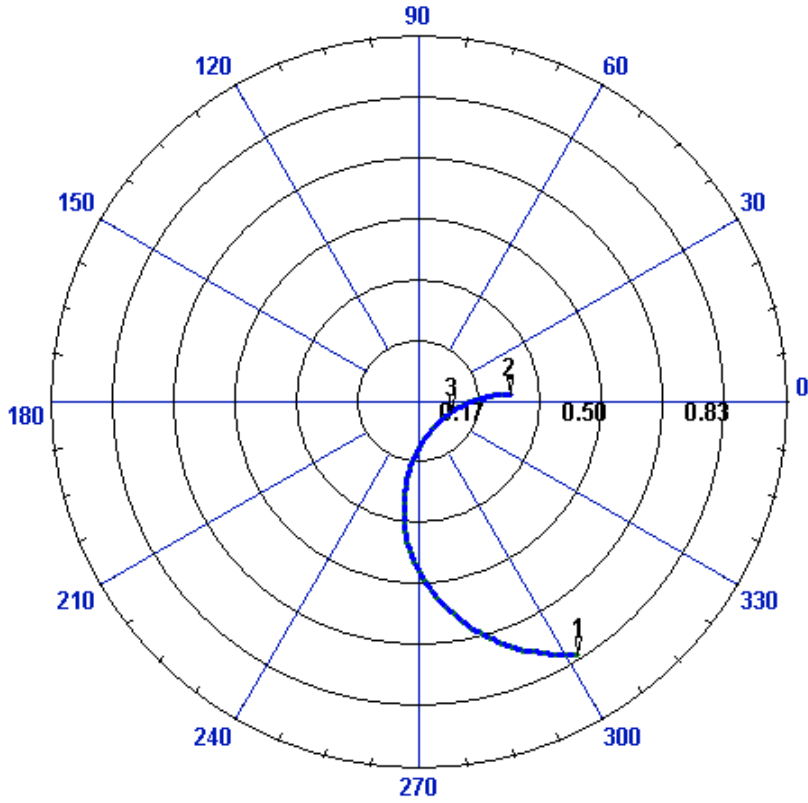

| |
|-------------|
| M1= 0.813 |
| P1= -57.832 |
| 0.500GHz |
| M2= 0.249 |
| P2= 4.574 |
| 1.000GHz |
| M3= 0.094 |
| P3= -18.148 |
| 0.880GHz |

S22
TQ3131 Amps Mode S-Parameters S11

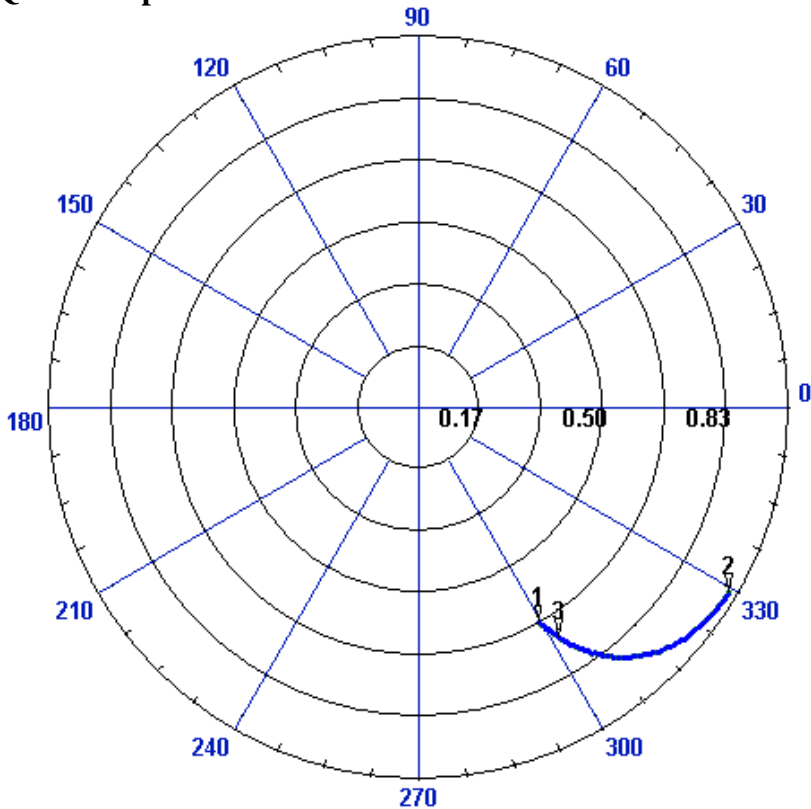

| |
|-------------|
| M1= 0.661 |
| P1= -60.851 |
| 1.000GHz |
| M2= 0.971 |
| P2= -30.548 |
| 0.500GHz |
| M3= 0.721 |
| P3= -58.469 |
| 0.880GHz |

TQ3131
Data Sheet

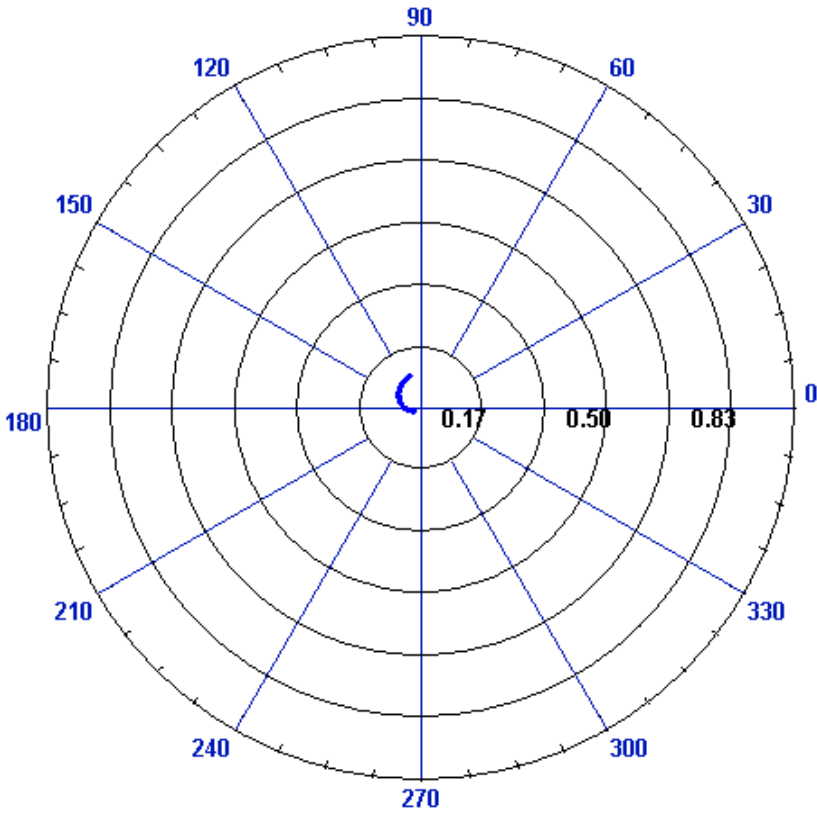

S12

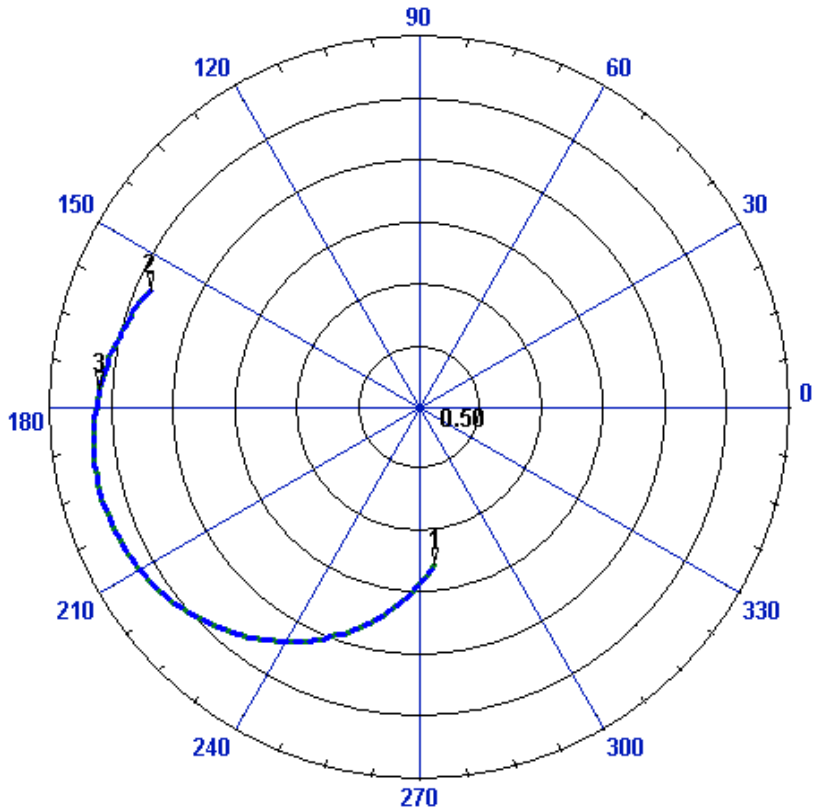

| |
|-------------|
| M1= 1.272 |
| P1= -84.698 |
| 0.500GHz |
| M2= 2.376 |
| P2= 156.462 |
| 1.000GHz |
| M3= 2.599 |
| P3= 176.662 |
| 0.880GHz |

S21

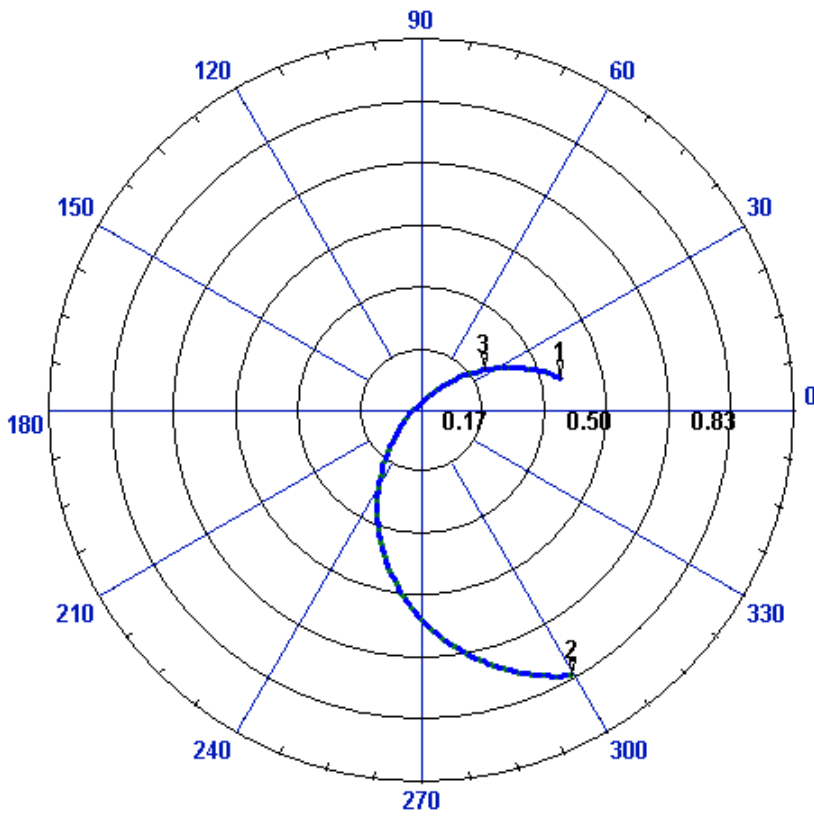

| |
|-------------|
| M1= 0.381 |
| P1= 13.304 |
| 1.000GHz |
| M2= 0.818 |
| P2= -60.502 |
| 0.500GHz |
| M3= 0.200 |
| P3= 33.418 |
| 0.880GHz |

S22

TQ3131

Data Sheet

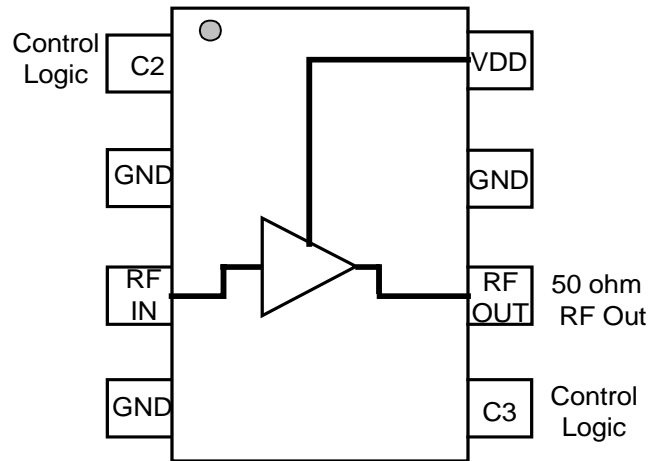

Package Pinout

Pin Descriptions

| Pin Name | Pin # | Description and Usage |
|----------|-------|--|
| C2 | 1 | Control logic 2 |
| GND | 2 | Ground, paddle |
| RF IN | 3 | RF input, off-chip matching required |
| LNA GND | 4 | Ground |
| C3 | 5 | Control logic 3 |
| RF OUT | 6 | RF output, no matching required |
| LNA GND | 7 | Ground |
| Vdd | 8 | LNA Vdd, typical 2.8V, C2 capacitor required |

Package Type: SOT23-8 Plastic Package

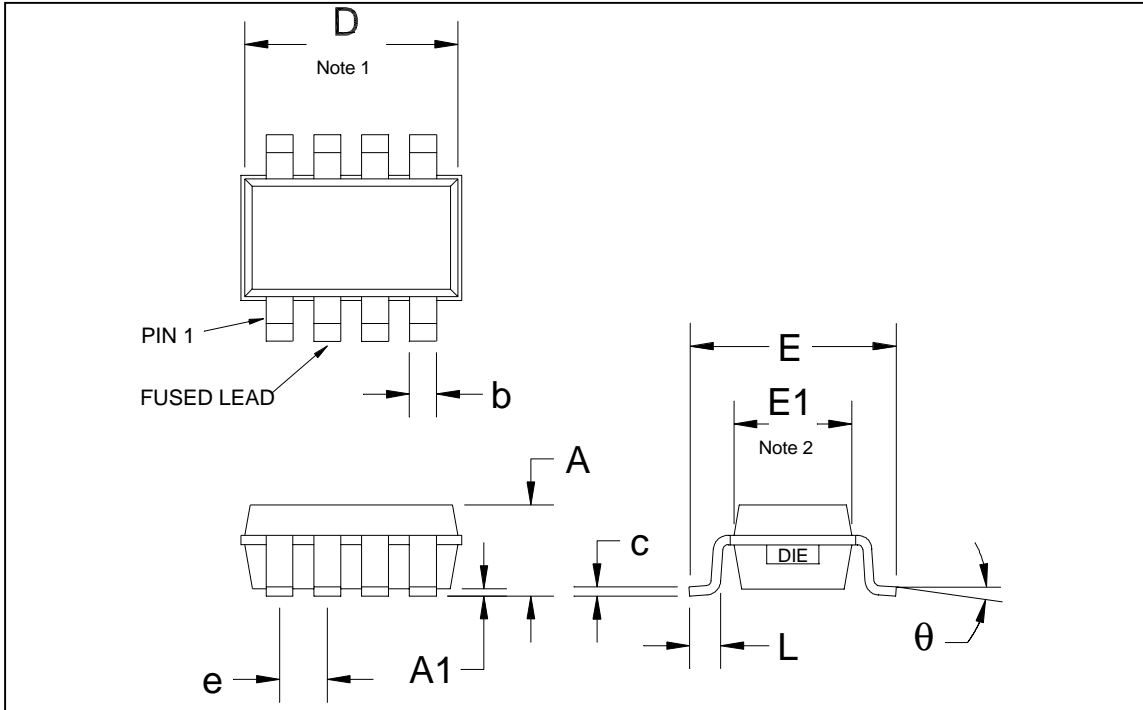

| DESIGNATION | DESCRIPTION | METRIC | ENGLISH | NOTE |
|-------------|----------------|-----------------|------------------|------|
| A | OVERALL HEIGHT | 1.20 +/- .25 mm | 0.05 +/- .250 in | 3 |
| A1 | STANDOFF | .100 +/- .05 mm | .004 +/- .002 in | 3 |
| b | LEAD WIDTH | .365 mm TYP | .014 in | 3 |
| c | LEAD THICKNESS | .127 mm TYP | .005 in | 3 |
| D | PACKAGE LENGTH | 2.90 +/- .10 mm | .114 +/- .004 in | 1,3 |
| e | LEAD PITCH | .65 mm TYP | .026 in | 3 |
| E | LEAD TIP SPAN | 2.80 +/- .20 mm | .110 +/- .008 in | 3 |
| E1 | PACKAGE WIDTH | 1.60 +/- .10 mm | .063 +/- .004 in | 2,3 |
| L | FOOT LENGTH | .45 +/- .10 mm | .018 +/- .004 in | 3 |
| Theta | FOOT ANGLE | 1.5 +/- 1.5 DEG | 1.5 +/- 1.5 DEG | |

Notes

1. The package length dimension includes allowance for mold mismatch and flashing.
2. The package width dimension includes allowance for mold mismatch and flashing.
3. Primary dimensions are in metric millimeters. The English equivalents are calculated and subject to rounding error.

TQ3131

Data Sheet

Additional Information

For latest specifications, additional product information, worldwide sales and distribution locations, and information about TriQuint:

Web: www.triquint.com **Tel:** (503) 615-9000
Email: info_wireless@tqs.com **Fax:** (503) 615-8900

For technical questions and additional information on specific applications:

Email: info_wireless@tqs.com

The information provided herein is believed to be reliable; TriQuint assumes no liability for inaccuracies or omissions. TriQuint assumes no responsibility for the use of this information, and all such information shall be entirely at the user's own risk. Prices and specifications are subject to change without notice. No patent rights or licenses to any of the circuits described herein are implied or granted to any third party.

TriQuint does not authorize or warrant any TriQuint product for use in life-support devices and/or systems.

Copyright © 1998 TriQuint Semiconductor, Inc. All rights reserved.

Revision A, January, 2000