

Data Sheet

Features

- For broadband applications
- Typical 3dB bandwidth of 3.8 MHz
- High attenuation
- Single-ended operation
- Ceramic Surface Mount Package (SMP)
- Small size
- Replaces Sawtek Part 851549 (BW 3dB=3.5MHz)

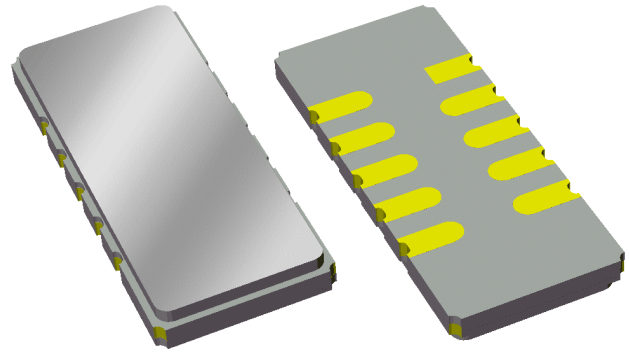

Package

Surface Mount 15.3 x 6.50 x 1.50 mm

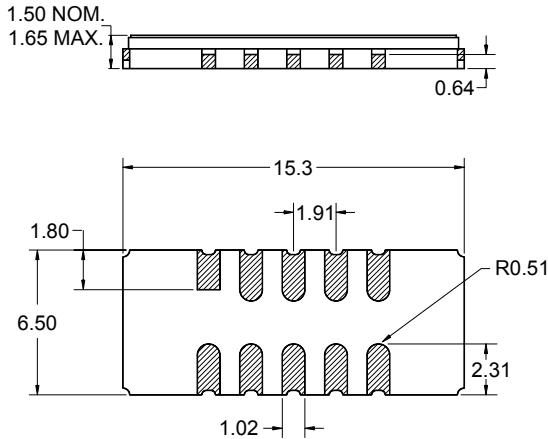

Pin Configuration

Bottom View

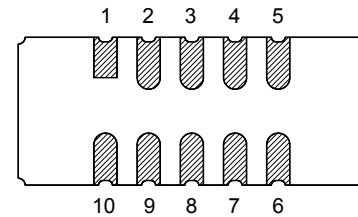

Pin No.	Description
5	Output
10	Input
1,6	Ground
2,3,4,7,8,9	Case ground

Dimensions shown are nominal in millimeters
 All tolerances are $\pm 0.15\text{mm}$ except overall
 length and width $+0.15\text{mm}/-0.10\text{mm}$

Body: Al_2O_3 ceramic
 Lid: Kovar, Ni plated
 Terminations: Au plating 0.5 - 1.0 μm ,
 over a 2 - 6 μm Ni plating

Data Sheet
Electrical Specifications ⁽¹⁾

 Operating Temperature Range: ⁽²⁾ 0 to +70 °C

Parameter ⁽³⁾	Minimum	Typical	Maximum	Unit
Center Frequency	-	70	-	MHz
Minimum Insertion Loss	-	19	22	dB
Lower 1 dB Bandedge ⁽⁴⁾	-	68.35	68.6	MHz
Upper 1 dB Bandedge	71.4	71.68	-	MHz
Lower 3 dB Bandedge ⁽⁴⁾	-	68.12	68.2	MHz
Upper 3 dB Bandedge	71.8	71.92	-	MHz
Lower 40 dB Bandedge ⁽⁴⁾	67	67.31	-	MHz
Upper 40 dB Bandedge	-	72.75	73	MHz
Amplitude Variation 68.6 - 71.4 MHz	-	0.6	1	dB p-p
Phase Linearity 68.6 - 71.4 MHz	-	3.5	6	deg p-p
Group Delay Variation 68.6 - 71.4 MHz	-	84	150	nsec
Absolute Delay	-	2.03	-	µsec
Relative Attenuation ⁽⁴⁾				
10 - 30 MHz	50	58	-	dB
30 - 66.7 MHz	44	49	-	dB
73.3 - 110 MHz	40	46	-	dB
110 - 200 MHz	50	60	-	dB
Source Impedance: ⁽⁵⁾	-	50	-	Ω
Load Impedance: ⁽⁵⁾	-	50	-	Ω
Substrate Material	-	LiTaO ₃	-	-
Temperature Coefficient of Frequency	-	-23	-	ppm/°C

Notes:

1. All specifications are based on the test circuit shown below
2. In production, devices will be tested at room temperature to a guardbanded specification to ensure electrical compliance over temperature
3. Electrical margin has been built into the design to account for the variations due to temperature drift and manufacturing tolerances
4. All attenuation measurements are measured relative to minimum insertion loss
5. This is the optimum impedance in order to achieve the performance shown

Test Circuit:

Actual matching values may vary due to PCB layout and parasitics

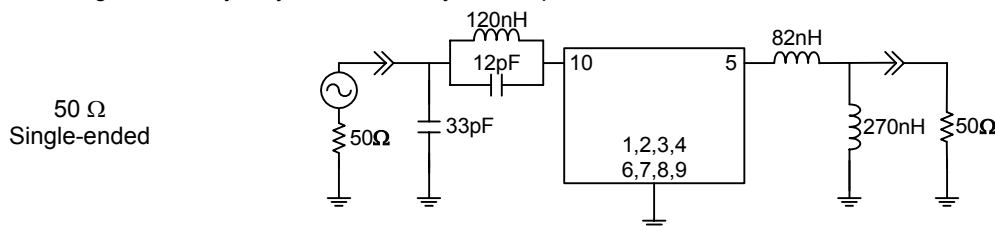

Data Sheet

Typical Performance (at +25°C)

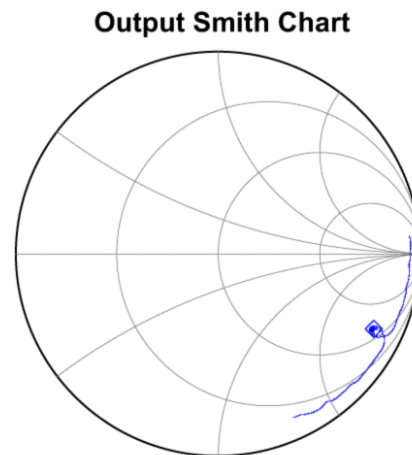
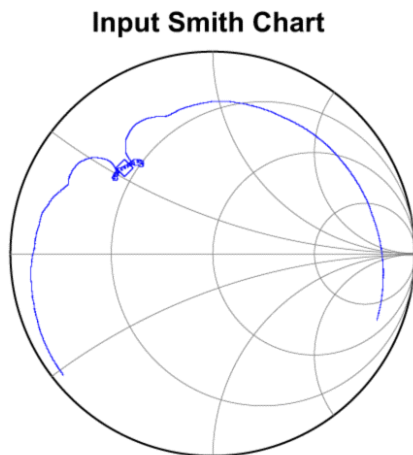
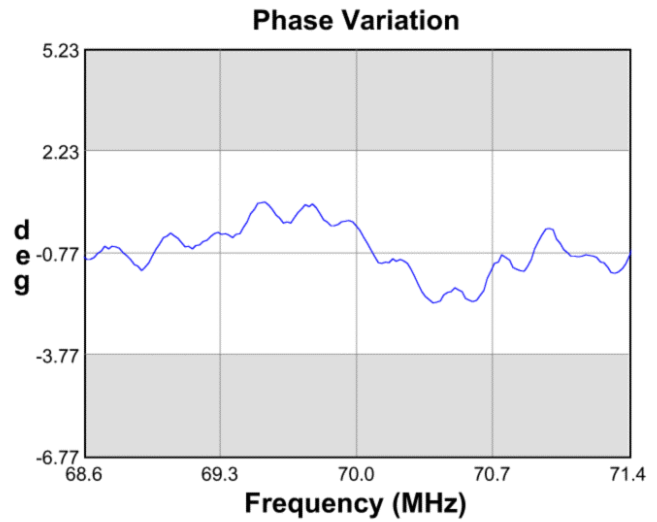
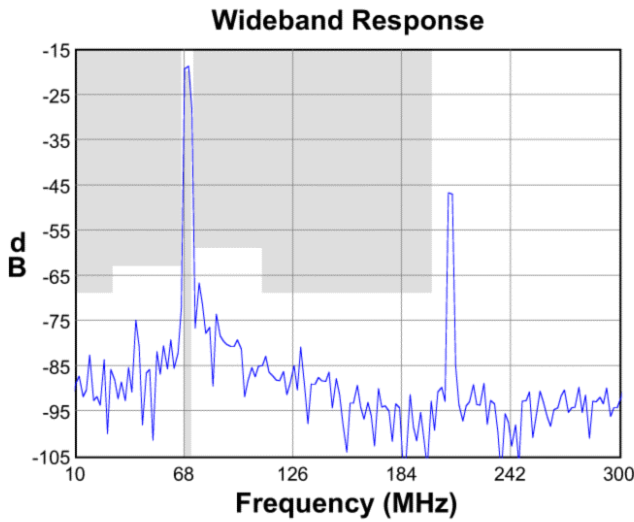
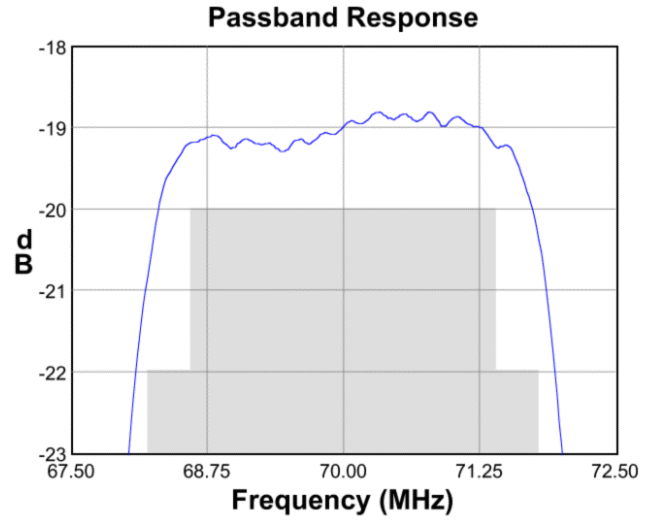
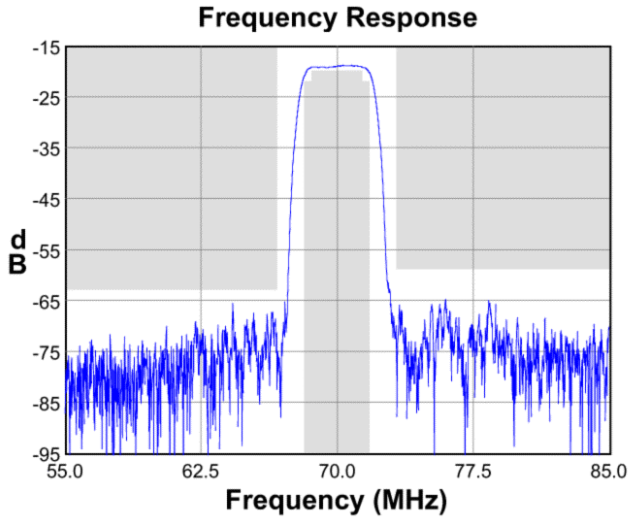

Data Sheet

Matching Schematics

Actual matching values may vary due to PCB layout and parasitics

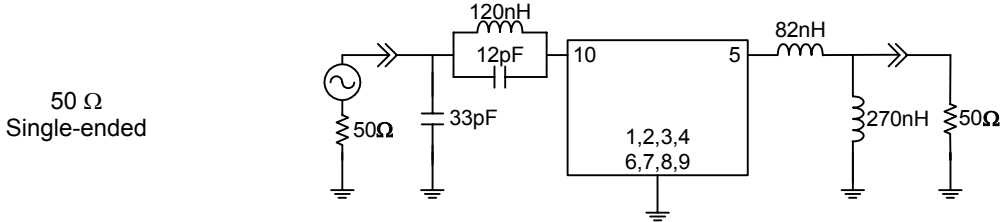

Marking

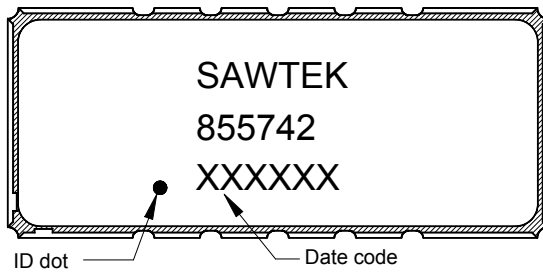

The date code consists of: JJJ = Julian day,
Y = last digit of year, M = manufacturing site code

PCB Footprint

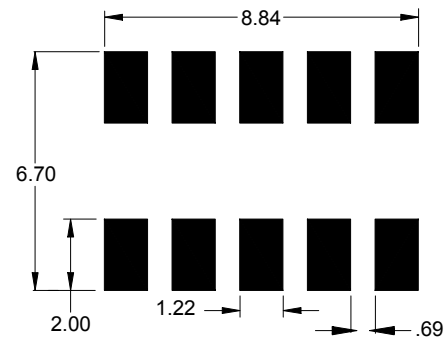

This footprint represents a recommendation only
Dimensions shown are nominal in millimeters

Tape and Reel

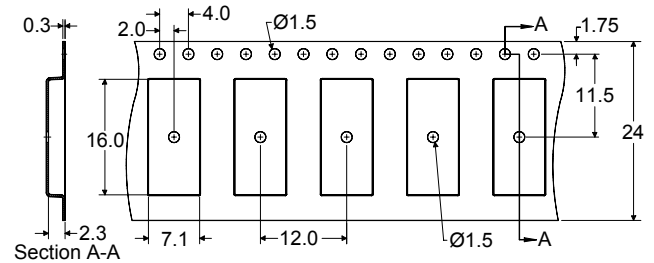
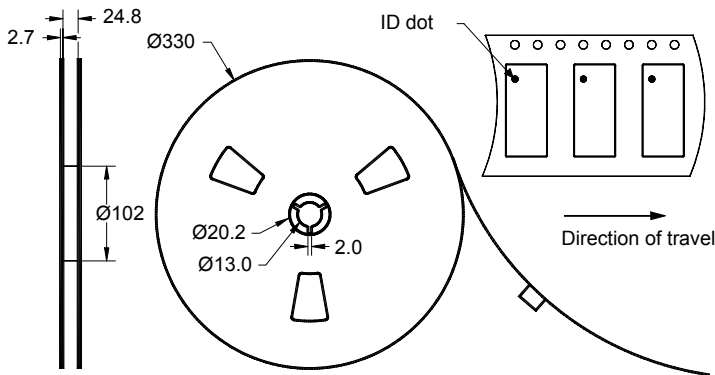

Dimensions shown are nominal in millimeters
Packaging quantity: 2000 units/reel

Data Sheet

Maximum Ratings

Parameter	Symbol	Minimum	Typical	Maximum	Unit
Operating Temperature Range	T	0	+25	+70	°C
Storage Temperature Range	T _{stg}	-40	-	+85	°C

Warnings

- Electrostatic Sensitive Device (ESD) 
- Avoid ultrasonic exposure

Links to Additional Technical Information

[PCB Layout Tips](#)

[Qualification Flowchart](#)

[Soldering Profile](#)

[S-Parameters](#)

[Other Technical Information](#)

Contact Information



PO Box 609501
 Orlando, FL 32860-9501
 USA

Phone: +1 (407) 886-8860
 Fax: +1 (407) 886-7061
 Email: custservice@sawtek.com
 Web: www.sawtek.com

Or contact one of our worldwide
 Network of [sales offices](#),
[Representatives or distributors](#)