

Table 1: Main Features

Symbol	Value	Unit
$I_{T(RMS)}$	1	A
V_{DRM}/V_{RRM}	600 to 800	V
$I_{GT}(Q_1)$	3 to 25	mA

DESCRIPTION

The Z01 series is suitable for general purpose AC switching applications. They can be found in applications such as home appliances (electrovalve, pump, door lock, small lamp control), fan speed controllers,...

Different gate current sensitivities are available, allowing optimized performances when controlled directly from microcontrollers.

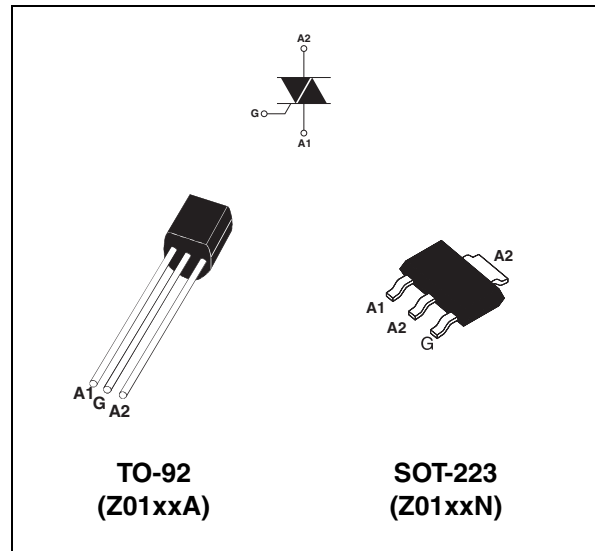
Table 2: Order Codes

Part Number	Marking
Z01xxA	See page table 8 on page 7
Z01xxN	

Table 3: Absolute Maximum Ratings

Symbol	Parameter	Value	Unit	
$I_{T(RMS)}$	RMS on-state current (full sine wave)	SOT-223 $T_{tab} = 90^{\circ}C$	1	A
		TO-92 $T_L = 50^{\circ}C$		
I_{TSM}	Non repetitive surge peak on-state current (full cycle, T_j initial = $25^{\circ}C$)	F = 50 Hz t = 20 ms	8	A
		F = 60 Hz t = 16.7 ms	8.5	
I^2t	I^2t Value for fusing	$t_p = 10$ ms	0.35	A^2s
di/dt	Critical rate of rise of on-state current $I_G = 2 \times I_{GT}$, $t_r \leq 100$ ns	F = 120 Hz $T_j = 125^{\circ}C$	20	A/ μs
I_{GM}	Peak gate current	$t_p = 20$ μs $T_j = 125^{\circ}C$	1	A
$P_{G(AV)}$	Average gate power dissipation	$T_j = 125^{\circ}C$	1	W
T_{stg} T_j	Storage junction temperature range Operating junction temperature range		- 40 to + 150 - 40 to + 125	$^{\circ}C$

Tables 4: Electrical Characteristics ($T_j = 25^\circ\text{C}$, unless otherwise specified)

Symbol	Test Conditions	Quadrant		Z01				Unit
				03	07	09	10	
$I_{GT} (1)$	$V_D = 12\text{ V}$ $R_L = 30\ \Omega$	I - II - III - IV	MAX.	3 5	5 7	10 10	25 25	mA
V_{GT}		ALL	MAX.	1.3				V
V_{GD}	$V_D = V_{DRM}$ $R_L = 3.3\ \text{k}\Omega$ $T_j = 125^\circ\text{C}$	ALL	MIN.	0.2				V
$I_H (2)$	$I_T = 50\ \text{mA}$		MAX.	7	10	10	25	mA
I_L	$I_G = 1.2\ I_{GT}$	I - III - IV	MAX.	7	10	15	25	mA
		II		15	20	25	50	
$dV/dt (2)$	$V_D = 67\ \%V_{DRM}$ gate open $T_j = 110^\circ\text{C}$		MIN.	10	20	50	100	V/ μs
$(dI/dt)_c (2)$	$(dV/dt)_c = 0.44\ \text{A/ms}$ $T_j = 110^\circ\text{C}$		MIN.	0.5	1	2	5	A/ms

Table 5: Static Characteristics

Symbol	Test Conditions			Value	Unit	
$V_{TM} (2)$	$I_{TM} = 1.4\ \text{A}$	$t_p = 380\ \mu\text{s}$	$T_j = 25^\circ\text{C}$	MAX.	1.56	V
$V_{to} (2)$	Threshold voltage		$T_j = 125^\circ\text{C}$	MAX.	0.95	V
$R_d (2)$	Dynamic resistance		$T_j = 125^\circ\text{C}$	MAX.	400	$\text{m}\Omega$
I_{DRM} I_{RRM}	$V_{DRM} = V_{RRM}$		$T_j = 25^\circ\text{C}$	MAX.	5	μA
			$T_j = 125^\circ\text{C}$		0.5	mA

Note 1: minimum I_{GT} is guaranteed at 5% of I_{GT} max.

Note 2: for both polarities of A2 referenced to A1.

Table 6: Thermal resistances

Symbol	Parameter		Value	Unit	
$R_{th(j-t)}$	Junction to tab (AC)		SOT-223	$^\circ\text{C/W}$	
$R_{th(j-l)}$	Junction to lead (AC)		TO-92		
$R_{th(j-a)}$	Junction to ambient	$S = 5\ \text{cm}^2$	SOT-223	60	$^\circ\text{C/W}$
			TO-92	150	

S = Copper surface under tab.

Figure 1: Maximum power dissipation versus RMS on-state current (full cycle)

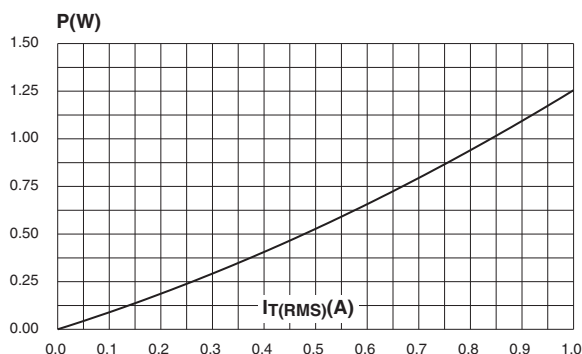

Figure 2: RMS on-state current versus case temperature (full cycle)

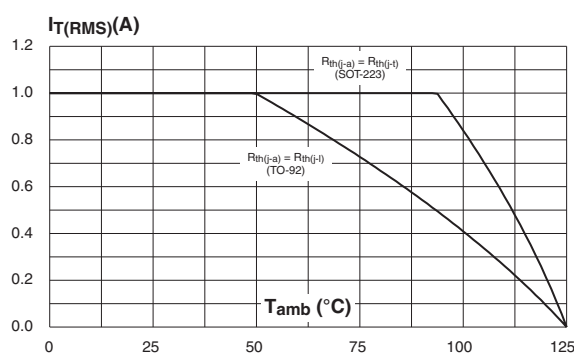

Figure 3: RMS on-state current versus ambient temperature (full cycle)

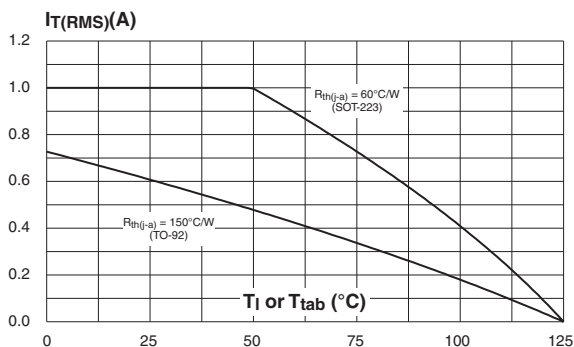

Figure 4: Relative variation of thermal impedance versus pulse duration

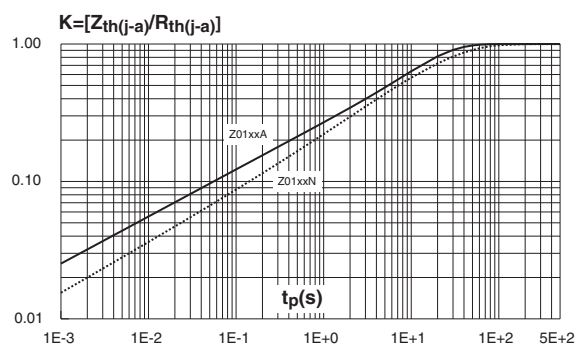

Figure 5: Relative variation of gate trigger current, holding current and latching current versus junction temperature (typical values)

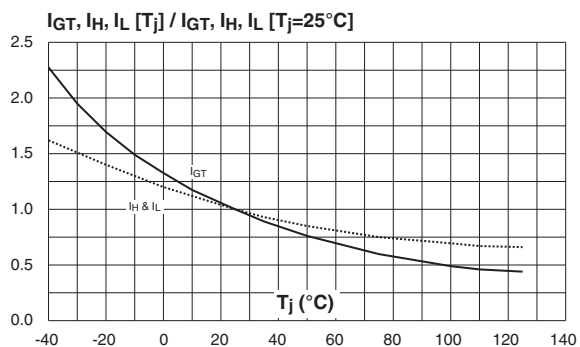

Figure 6: Surge peak on-state current versus number of cycles

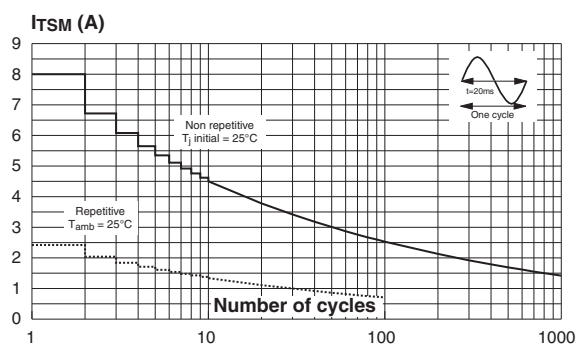

Figure 7: Non-repetitive surge peak on-state current for a sinusoidal pulse with width $t_p < 10$ ms and corresponding value of I^2t

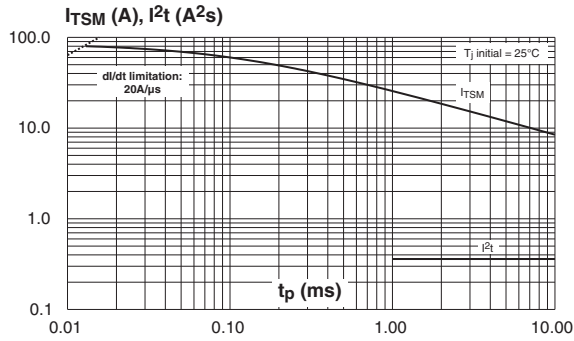

Figure 8: On-state characteristics (maximum values)

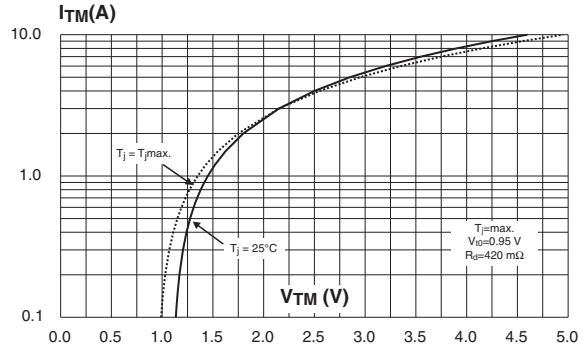

Figure 9: Relative variation of critical rate of decrease of main current versus $(dV/dt)_c$ (typical values)

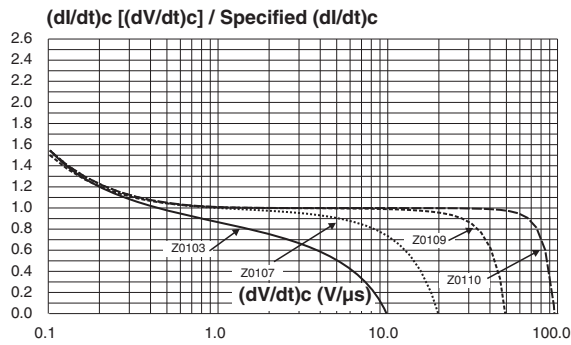

Figure 10: Relative variation of critical rate of decrease of main current versus junction temperature

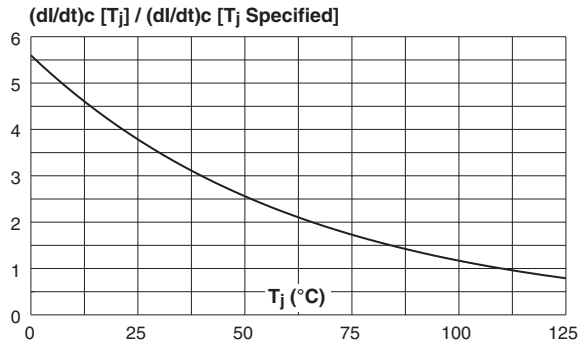

Figure 11: SOT-223 Thermal resistance junction to ambient versus copper surface under tab (printed circuit board FR4, copper thickness: $35 \mu m$)

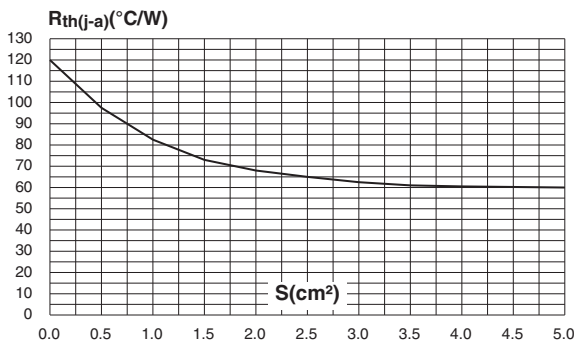

Figure 12: Ordering Information Scheme

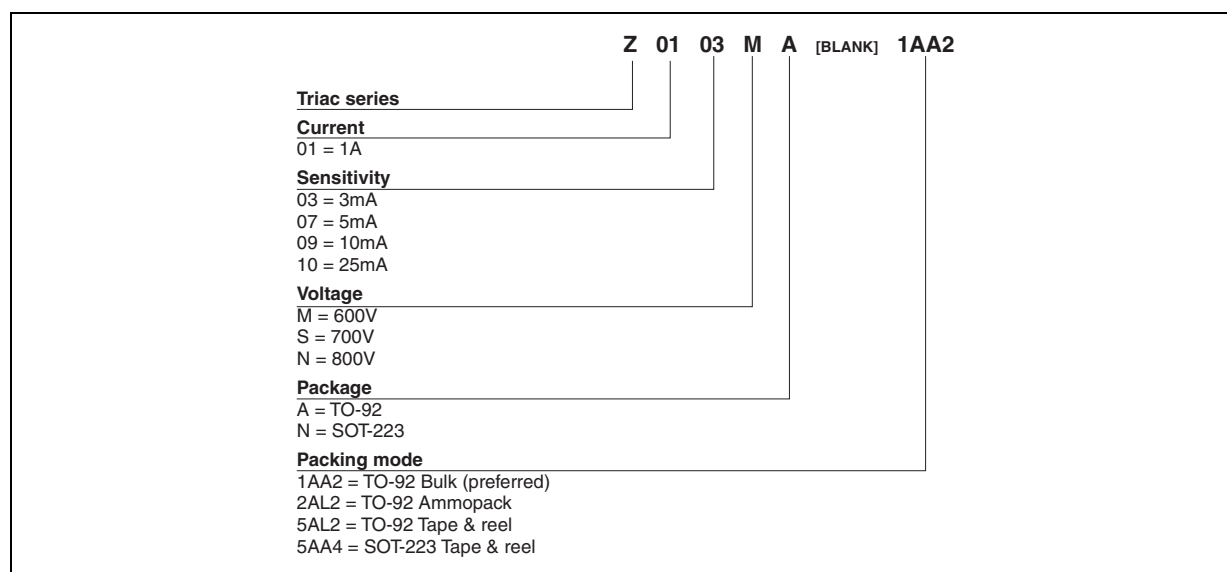

Table 7: Product Selector

Part Number	Voltage			Sensitivity	Type	Package
	600 V	700 V	800 V			
Z0103MA	X			3 mA	Standard	TO-92
Z0103MN	X			3 mA	Standard	SOT-223
Z0103SA		X		3 mA	Standard	TO-92
Z0103SN		X		3 mA	Standard	SOT-223
Z0103NA			X	3 mA	Standard	TO-92
Z0103NN			X	3 mA	Standard	SOT-223
Z0107MA	X			5 mA	Standard	TO-92
Z0107MN	X			5 mA	Standard	SOT-223
Z0107SA		X		5 mA	Standard	TO-92
Z0107SN		X		5 mA	Standard	SOT-223
Z0107NA			X	5 mA	Standard	TO-92
Z0107NN			X	5 mA	Standard	SOT-223
Z0109MA	X			10 mA	Standard	TO-92
Z0109MN	X			10 mA	Standard	SOT-223
Z0109SA		X		10 mA	Standard	TO-92
Z0109SN		X		10 mA	Standard	SOT-223
Z0109NA			X	10 mA	Standard	TO-92
Z0109NN			X	10 mA	Standard	SOT-223
Z0110MA	X			25 mA	Standard	TO-92
Z0110MN	X			25 mA	Standard	SOT-223
Z0110SA		X		25 mA	Standard	TO-92
Z0110SN		X		25 mA	Standard	SOT-223
Z0110NA			X	25 mA	Standard	TO-92
Z0110NN			X	25 mA	Standard	SOT-223

Figure 13: SOT-223 Package Mechanical Data

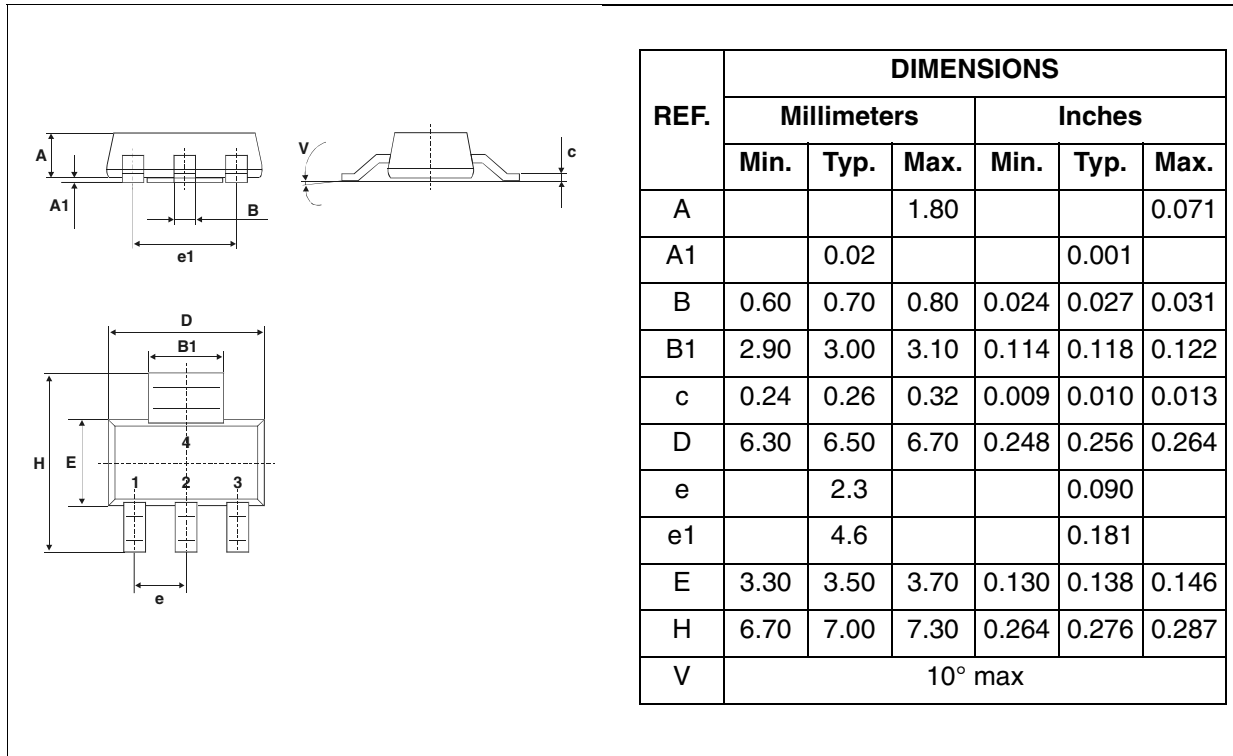

Figure 14: SOT-223 Foot Print Dimensions (in millimeters)

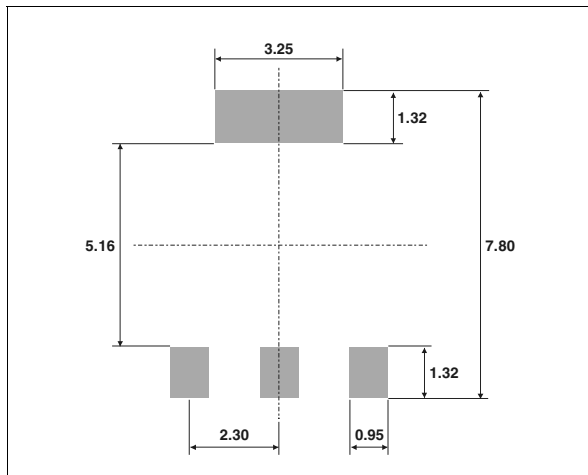

Figure 15: TO-92 Package Mechanical Data

REF.	DIMENSIONS					
	Millimeters			Inches		
	Min.	Typ.	Max.	Min.	Typ.	Max.
A		1.35			0.053	
B			4.70			0.185
C		2.54			0.100	
D	4.40			0.173		
E	12.70			0.500		
F			3.70			0.146
a			0.50			0.019

Table 8: Ordering Information

Ordering type	Marking	Weight	Base quantity	Delivery mode
Z01xxyA 1AA2	Z01xxyA	0.2 g	2500	Bulk
Z01xxyA 2AL2	Z01xxyA	0.2 g	2000	Ammopack
Z01xxyA 5AL2	Z01xxyA	0.2 g	2000	Tape & reel
Z0103yN 5AA4	Z3y	0.12 g	1000	Tape & reel
Z0107yN 5AA4	Z7y	0.12 g	1000	Tape & reel
Z0109yN 5AA4	Z9y	0.12 g	1000	Tape & reel

Note: xxx = sensitivity, y = voltage

Table 9: Revision History

Date	Revision	Description of Changes
Oct-2001	4	Last update.
10-Feb-2005	5	Package: TO-92 tape & reel delivery mode 5AL2 added.

Information furnished is believed to be accurate and reliable. However, STMicroelectronics assumes no responsibility for the consequences of use of such information nor for any infringement of patents or other rights of third parties which may result from its use. No license is granted by implication or otherwise under any patent or patent rights of STMicroelectronics. Specifications mentioned in this publication are subject to change without notice. This publication supersedes and replaces all information previously supplied. STMicroelectronics products are not authorized for use as critical components in life support devices or systems without express written approval of STMicroelectronics.

The ST logo is a registered trademark of STMicroelectronics.
All other names are the property of their respective owners

© 2005 STMicroelectronics - All rights reserved

STMicroelectronics group of companies

Australia - Belgium - Brazil - Canada - China - Czech Republic - Finland - France - Germany - Hong Kong - India - Israel - Italy - Japan -
Malaysia - Malta - Morocco - Singapore - Spain - Sweden - Switzerland - United Kingdom - United States of America
www.st.com