



# VNS3NV04D

## “OMNIFET II”: FULLY AUTOPROTECTED POWER MOSFET

TYPE	$R_{DS(on)}$	$I_{lim}$	$V_{clamp}$
VNS3NV04D	120 m $\Omega$ (*)	3.5 A (*)	40 V (*)

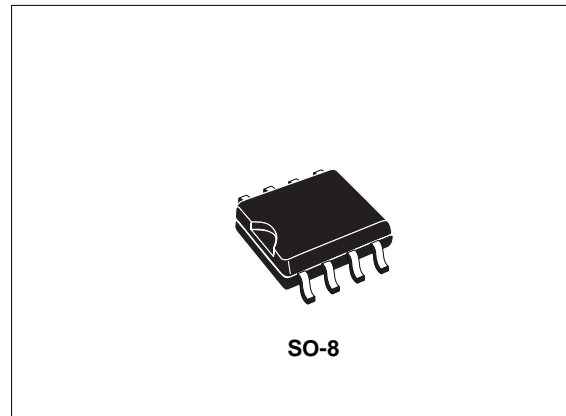
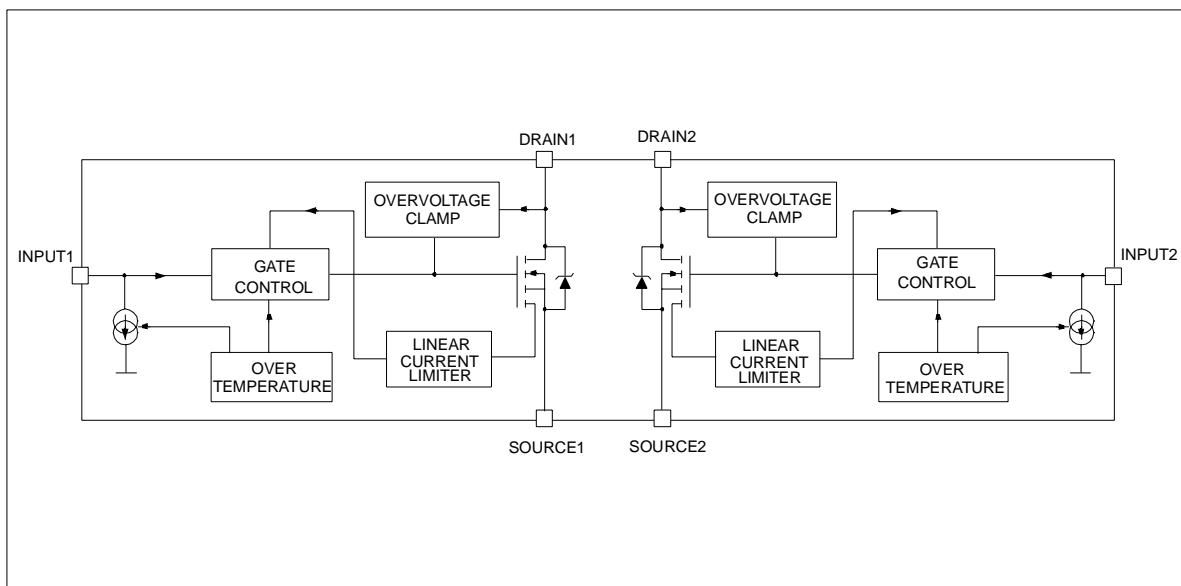
(\*)Per each device

- LINEAR CURRENT LIMITATION
- THERMAL SHUT DOWN
- SHORT CIRCUIT PROTECTION
- INTEGRATED CLAMP
- LOW CURRENT DRAWN FROM INPUT PIN
- DIAGNOSTIC FEEDBACK THROUGH INPUT PIN
- ESD PROTECTION
- DIRECT ACCESS TO THE GATE OF THE POWER MOSFET (ANALOG DRIVING)
- COMPATIBLE WITH STANDARD POWER MOSFET

### DESCRIPTION

The VNS3NV04D is a device formed by two monolithic OMNIFET II chips housed in a standard SO-8 package. The OMNIFET II are designed in STMicroelectronics VIPower M0-3 Technology: they are intended for replacement of standard Power MOSFETS from DC up to 50KHz

### BLOCK DIAGRAM



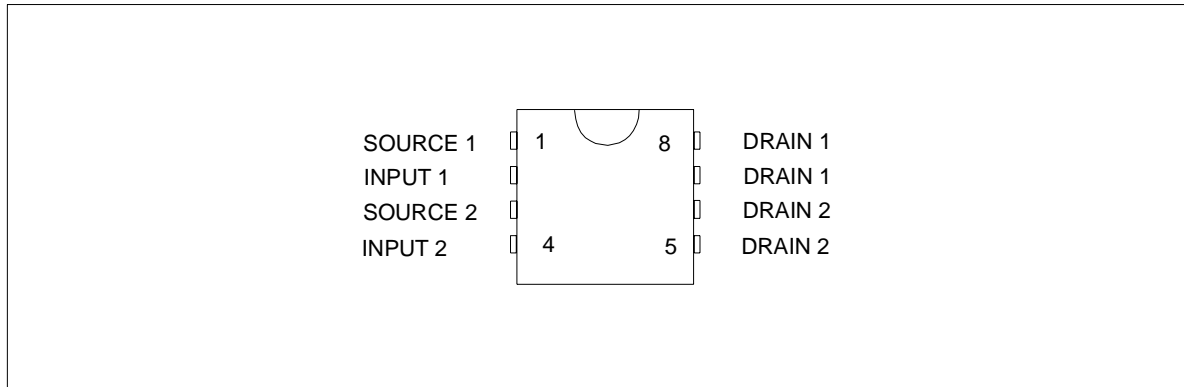
applications. Built in thermal shutdown, linear current limitation and overvoltage clamp protects the chip in harsh environments. Fault feedback can be detected by monitoring the voltage at the input pin.

# VNS3NV04D

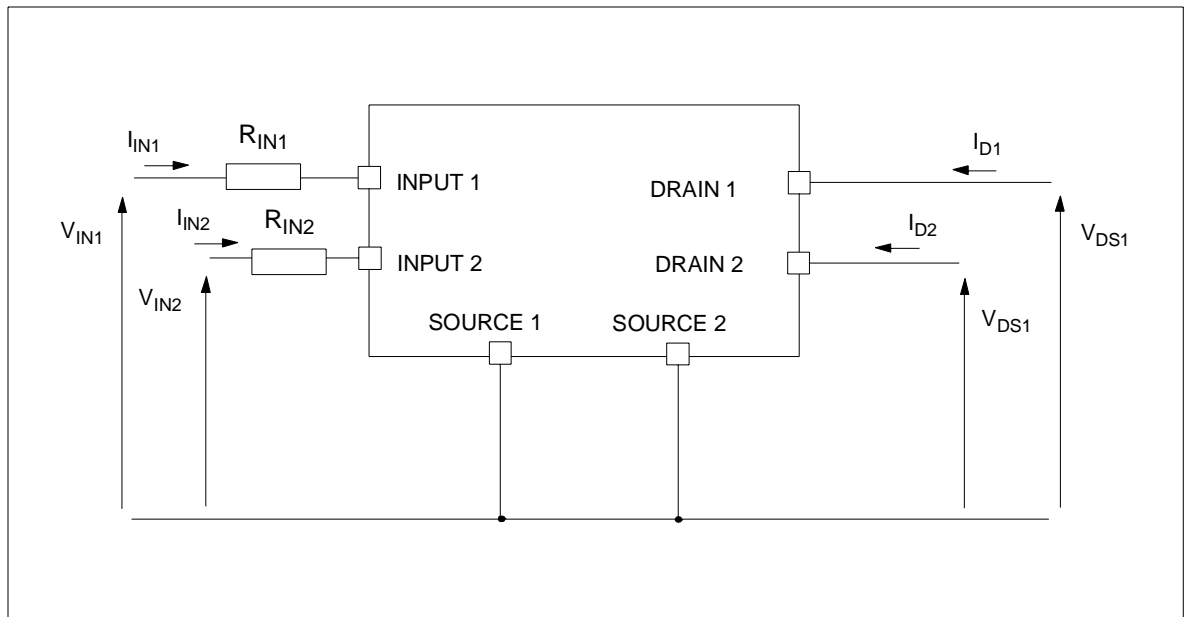
## ABSOLUTE MAXIMUM RATING

Symbol	Parameter	Value	Unit
$V_{DSn}$	Drain-source Voltage ( $V_{INn}=0V$ )	Internally Clamped	V
$V_{INn}$	Input Voltage	Internally Clamped	V
$I_{INn}$	Input Current	+/-20	mA
$R_{IN MINn}$	Minimum Input Series Impedance	220	$\Omega$
$I_{Dn}$	Drain Current	Internally Limited	A
$I_{Rn}$	Reverse DC Output Current	-5.5	A
$V_{ESD1}$	Electrostatic Discharge ( $R=1.5K\Omega$ , $C=100pF$ )	4000	V
$V_{ESD2}$	Electrostatic Discharge on output pins only ( $R=330\Omega$ , $C=150pF$ )	16500	V
$P_{tot}$	Total Dissipation at $T_c=25^\circ C$	4	W
$T_j$	Operating Junction Temperature	Internally limited	$^\circ C$
$T_c$	Case Operating Temperature	Internally limited	$^\circ C$
$T_{stg}$	Storage Temperature	-55 to 150	$^\circ C$

## CONNECTION DIAGRAM (TOP VIEW)



## CURRENT AND VOLTAGE CONVENTIONS



**THERMAL DATA**

Symbol	Parameter	Value	Unit
$R_{thj-lead}$	Thermal Resistance Junction-lead (per channel)	MAX	30
$R_{thj-amb}$	Thermal Resistance Junction-ambient	MAX	80(*)

(\*) When mounted on a standard single-sided FR4 board with 50mm<sup>2</sup> of Cu (at least 35 μm thick) connected to all DRAIN pins of the relative channel.

**ELECTRICAL CHARACTERISTICS** (-40°C < T<sub>j</sub> < 150°C, unless otherwise specified)  
(Per each device)

**OFF**

Symbol	Parameter	Test Conditions	Min	Typ	Max	Unit
$V_{CLAMP}$	Drain-source Clamp Voltage	$V_{IN}=0V; I_D=1.5A$	40	45	55	V
$V_{CLTH}$	Drain-source Clamp Threshold Voltage	$V_{IN}=0V; I_D=2mA$	36			V
$V_{INTH}$	Input Threshold Voltage	$V_{DS}=V_{IN}; I_D=1mA$	0.5		2.5	V
$I_{ISS}$	Supply Current from Input Pin	$V_{DS}=0V; V_{IN}=5V$		100	150	μA
$V_{INCL}$	Input-Source Clamp Voltage	$I_{IN}=1mA$ $I_{IN}=-1mA$	6 -1.0	6.8	8 -0.3	V
$I_{DSS}$	Zero Input Voltage Drain Current ( $V_{IN}=0V$ )	$V_{DS}=13V; V_{IN}=0V; T_j=25°C$ $V_{DS}=25V; V_{IN}=0V$			30 75	μA

**ON**

Symbol	Parameter	Test Conditions	Min	Typ	Max	Unit
$R_{DS(on)}$	Static Drain-source On Resistance	$V_{IN}=5V; I_D=1.5A; T_j=25°C$ $V_{IN}=5V; I_D=1.5A$			120 240	mΩ

## VNS3NV04D

### ELECTRICAL CHARACTERISTICS (continued) ( $T_j=25^\circ\text{C}$ , unless otherwise specified)

#### DYNAMIC

Symbol	Parameter	Test Conditions	Min	Typ	Max	Unit
$g_{fs}^*$	Forward Transconductance	$V_{DD}=13\text{V}; I_D=1.5\text{A}$		5.0		S
$C_{OSS}$	Output Capacitance	$V_{DS}=13\text{V}; f=1\text{MHz}; V_{IN}=0\text{V}$		150		pF

#### SWITCHING

Symbol	Parameter	Test Conditions	Min	Typ	Max	Unit
$t_{d(on)}$	Turn-on Delay Time	$V_{DD}=15\text{V}; I_D=1.5\text{A}$		90	300	ns
$t_r$	Rise Time			250	750	ns
$t_{d(off)}$	Turn-off Delay Time	$V_{gen}=5\text{V}; R_{gen}=R_{IN\ MINn}=220\Omega$ (see figure 1)		450	1350	ns
$t_f$	Fall Time			250	750	ns
$t_{d(on)}$	Turn-on Delay Time	$V_{DD}=15\text{V}; I_D=1.5\text{A}$		0.45	1.35	$\mu\text{s}$
$t_r$	Rise Time			2.5	7.5	$\mu\text{s}$
$t_{d(off)}$	Turn-off Delay Time	$V_{gen}=5\text{V}; R_{gen}=2.2\text{K}\Omega$ (see figure 1)		3.3	10.0	$\mu\text{s}$
$t_f$	Fall Time			2.0	6.0	$\mu\text{s}$
$(di/dt)_{on}$	Turn-on Current Slope	$V_{DD}=15\text{V}; I_D=1.5\text{A}$ $V_{gen}=5\text{V}; R_{gen}=R_{IN\ MINn}=220\Omega$		4.7		$\text{A}/\mu\text{s}$
$Q_i$	Total Input Charge	$V_{DD}=12\text{V}; I_D=1.5\text{A}; V_{IN}=5\text{V}$ $I_{gen}=2.13\text{mA}$ (see figure 5)		8.5		nC

#### SOURCE DRAIN DIODE

Symbol	Parameter	Test Conditions	Min	Typ	Max	Unit
$V_{SD}^*$	Forward On Voltage	$I_{SD}=1.5\text{A}; V_{IN}=0\text{V}$		0.8		V
$t_{rr}$	Reverse Recovery Time	$I_{SD}=1.5\text{A}; di/dt=12\text{A}/\mu\text{s}$		107		ns
$Q_{rr}$	Reverse Recovery Charge	$V_{DD}=30\text{V}; L=200\mu\text{H}$		37		$\mu\text{C}$
$I_{RRM}$	Reverse Recovery Current	(see test circuit, figure 2)		0.7		A

#### PROTECTIONS ( $-40^\circ\text{C} < T_j < 150^\circ\text{C}$ , unless otherwise specified)

Symbol	Parameter	Test Conditions	Min	Typ	Max	Unit
$I_{lim}$	Drain Current Limit	$V_{IN}=5\text{V}; V_{DS}=13\text{V}$	3.5	5	7	A
$t_{dlim}$	Step Response Current Limit	$V_{IN}=5\text{V}; V_{DS}=13\text{V}$		10		$\mu\text{s}$
$T_{jsh}$	Overtemperature Shutdown		150	175	200	$^\circ\text{C}$
$T_{jrs}$	Overtemperature Reset		135			$^\circ\text{C}$
$I_{gf}$	Fault Sink Current	$V_{IN}=5\text{V}; V_{DS}=13\text{V}; T_j=T_{jsh}$	10	15	20	mA
$E_{as}$	Single Pulse Avalanche Energy	starting $T_j=25^\circ\text{C}; V_{DD}=24\text{V}$ $V_{IN}=5\text{V}; R_{gen}=R_{IN\ MINn}=220\Omega; L=24\text{mH}$ (see figures 3 & 4)	100			mJ

(\*) Pulsed: Pulse duration = 300 $\mu\text{s}$ , duty cycle 1.5%

## PROTECTION FEATURES

During normal operation, the INPUT pin is electrically connected to the gate of the internal power MOSFET through a low impedance path.

The device then behaves like a standard power MOSFET and can be used as a switch from DC to 50KHz. The only difference from the user's standpoint is that a small DC current  $I_{SS}$  (typ. 100 $\mu$ A) flows into the INPUT pin in order to supply the internal circuitry.

The device integrates:

- **OVERVOLTAGE CLAMP PROTECTION:** internally set at 45V, along with the rugged avalanche characteristics of the Power MOSFET stage give this device unrivalled ruggedness and energy handling capability. This feature is mainly important when driving inductive loads.

- **LINEAR CURRENT LIMITER CIRCUIT:** limits the drain current  $I_D$  to  $I_{lim}$  whatever the INPUT pin voltage. When the current limiter is active, the device operates in the linear region, so power dissipation may exceed the capability of the heatsink. Both case and junction temperatures increase, and if this phase lasts long enough, junction temperature may reach the overtemperature threshold  $T_{jsh}$ .

- **OVERTEMPERATURE AND SHORT CIRCUIT PROTECTION:** these are based on sensing the chip temperature and are not dependent on the input voltage. The location of the sensing element on the chip in the power stage area ensures fast, accurate detection of the junction temperature. Overtemperature cutout occurs in the range 150 to 190 °C, a typical value being 170 °C. The device is automatically restarted when the chip temperature falls of about 15°C below shut-down temperature.

- **STATUS FEEDBACK:** in the case of an overtemperature fault condition ( $T_j > T_{jsh}$ ), the device tries to sink a diagnostic current  $I_{gf}$  through the INPUT pin in order to indicate fault condition. If driven from a low impedance source, this current may be used in order to warn the control circuit of a device shutdown. If the drive impedance is high enough so that the INPUT pin driver is not able to supply the current  $I_{gf}$ , the INPUT pin will fall to 0V. **This will not however affect the device operation: no requirement is put on the current capability of the INPUT pin driver except to be able to supply the normal operation drive current  $I_{SS}$ .**

Additional features of this device are ESD protection according to the Human Body model and the ability to be driven from a TTL Logic circuit.

Fig.1: Switching Time Test Circuit for Resistive Load

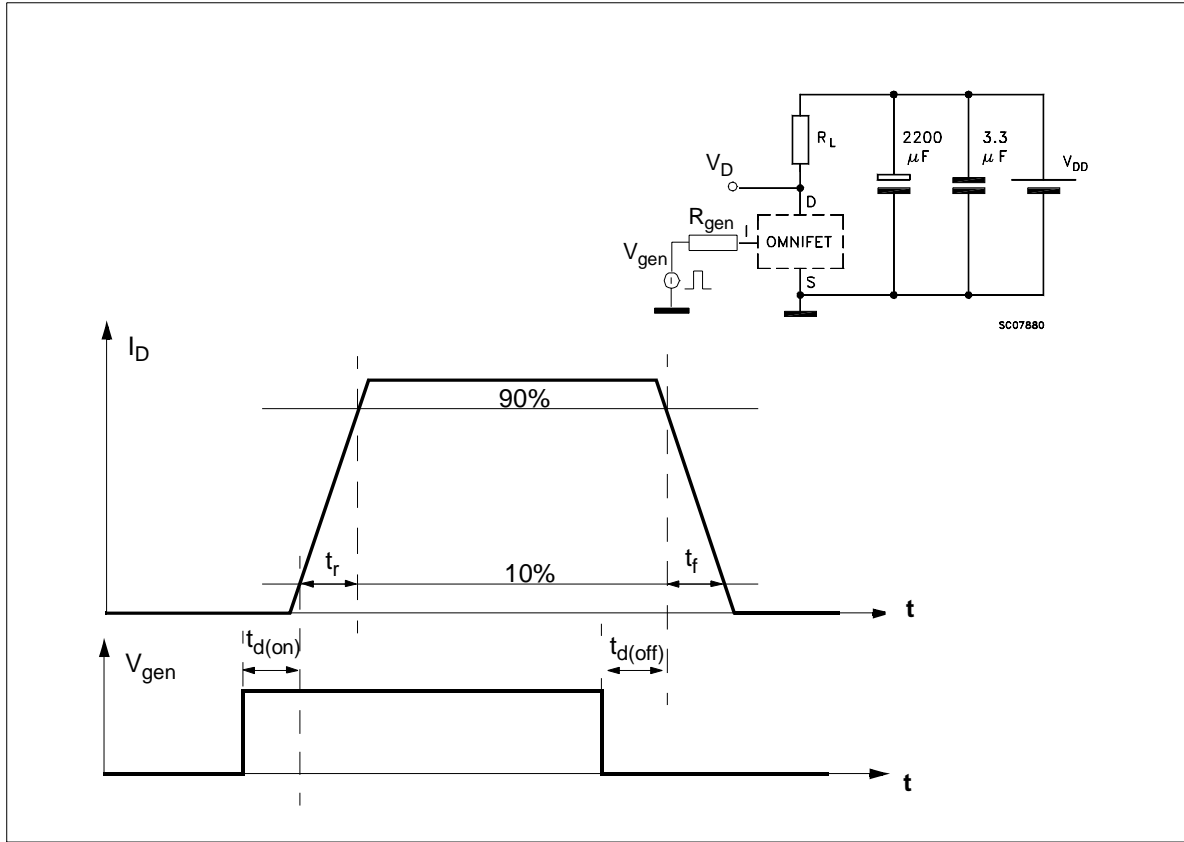
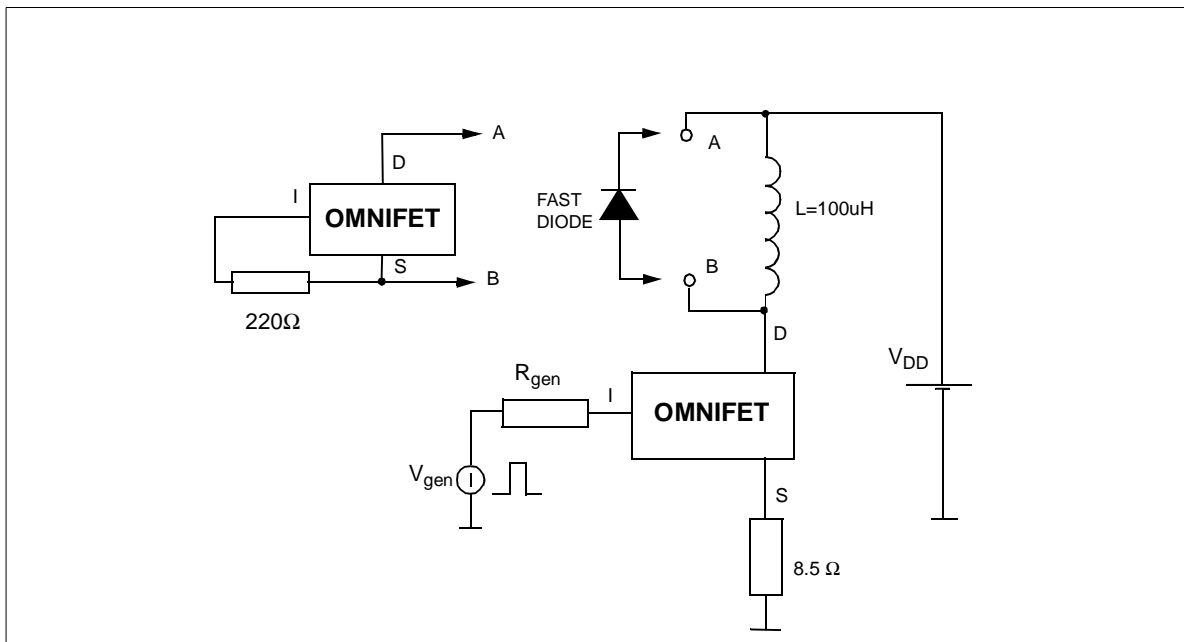
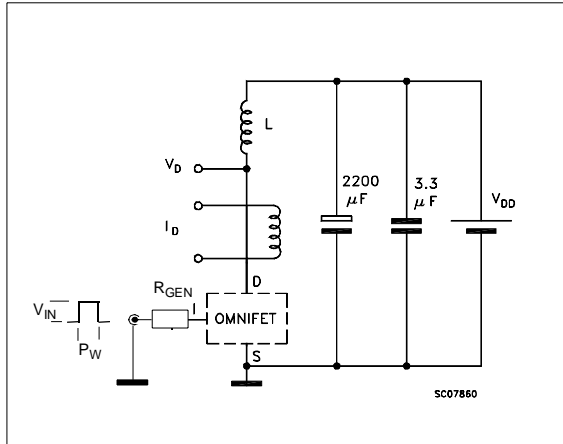


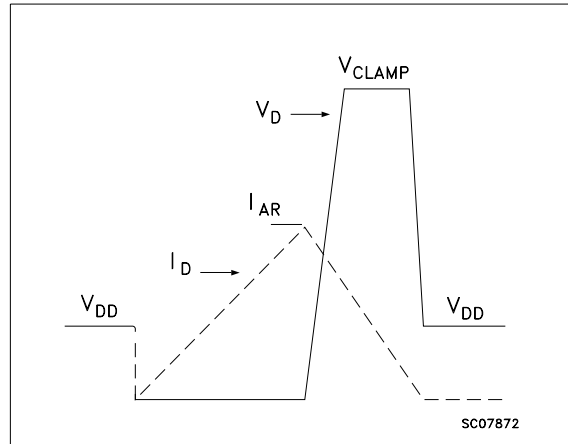
Fig.2: Test Circuit for Diode Recovery Times



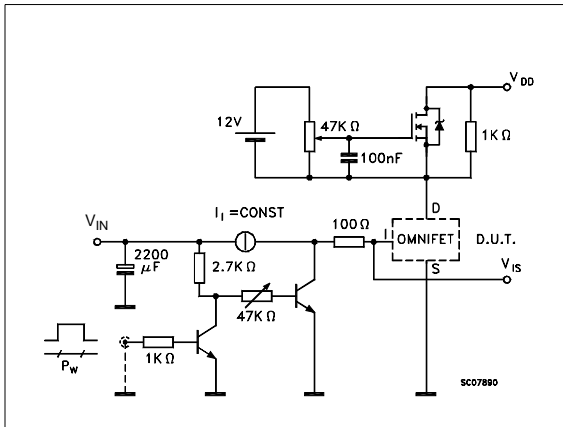
**Fig. 3: Unclamped Inductive Load Test Circuits**



**Fig. 4: Unclamped Inductive Waveforms**

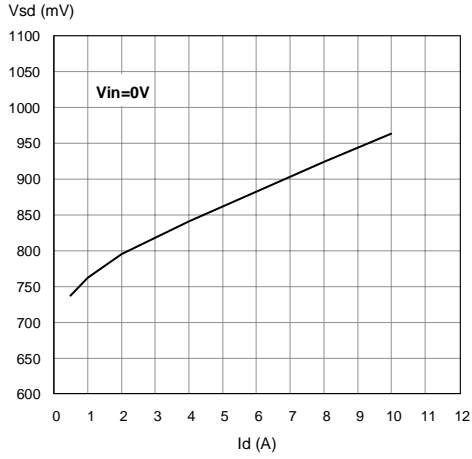


**Fig. 5: Input Charge Test Circuit**

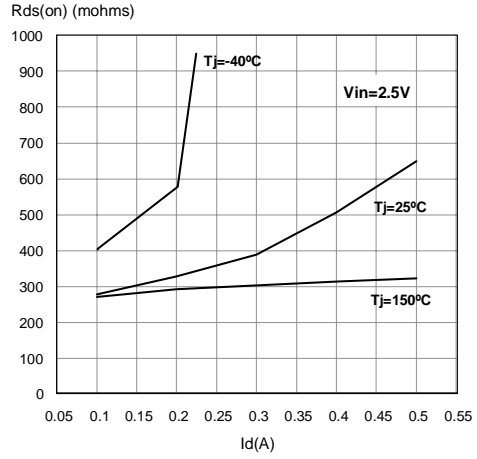


# VNS3NV04D

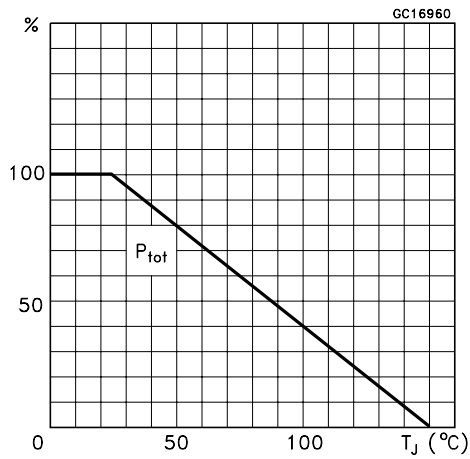
Source-Drain Diode Forward Characteristics



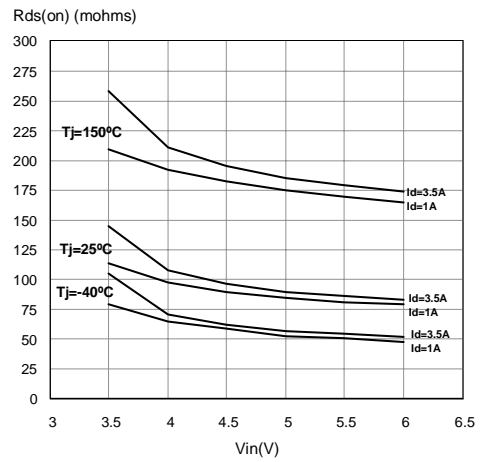
Static Drain Source On Resistance



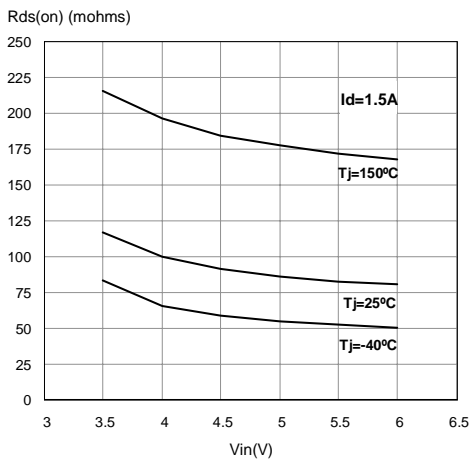
Derating Curve



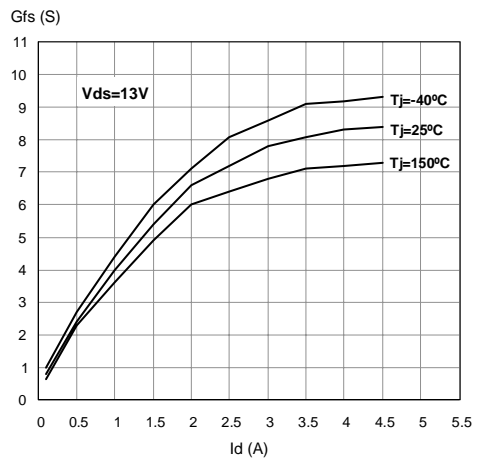
Static Drain-Source On resistance Vs. Input Voltage



Static Drain-Source On resistance Vs. Input Voltage

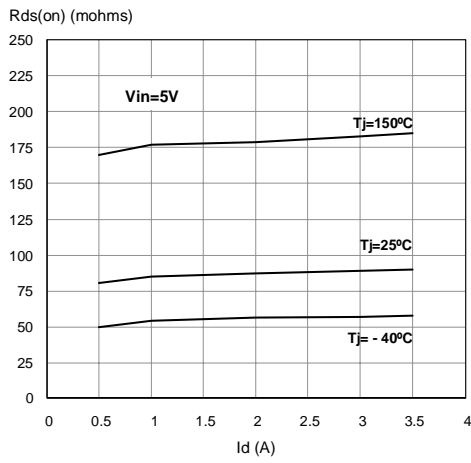


Transconductance

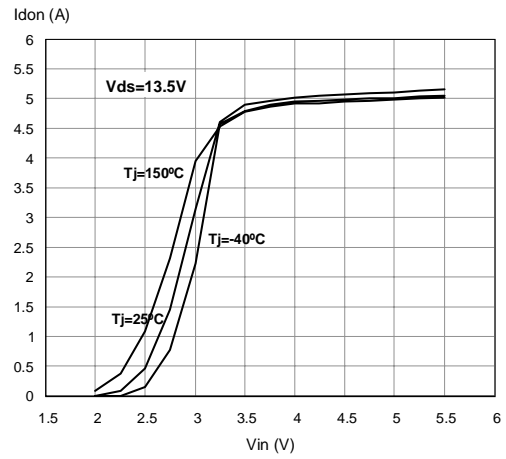




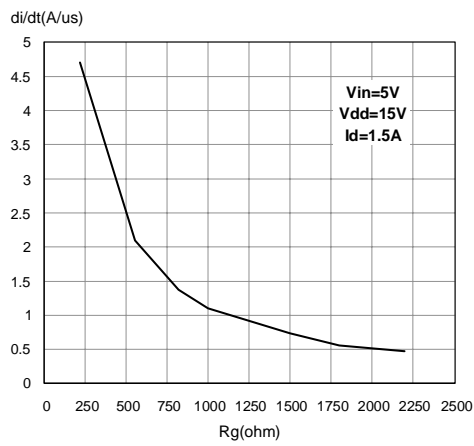
Static Drain-Source On Resistance Vs. Id



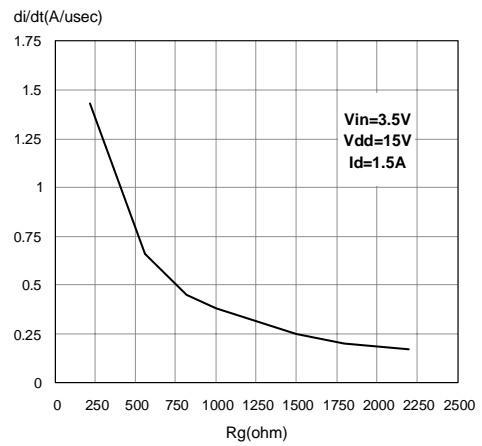
Transfer Characteristics



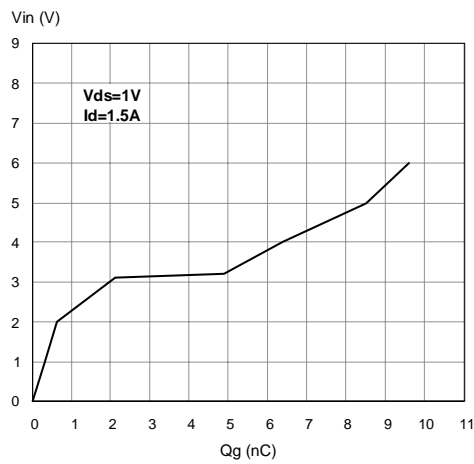
Turn On Current Slope



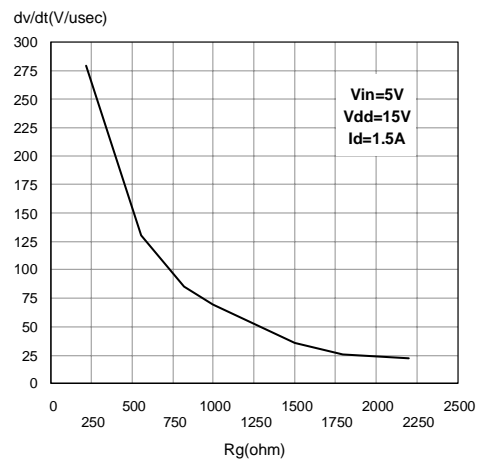
Turn On Current Slope



Input Voltage Vs. Input Charge

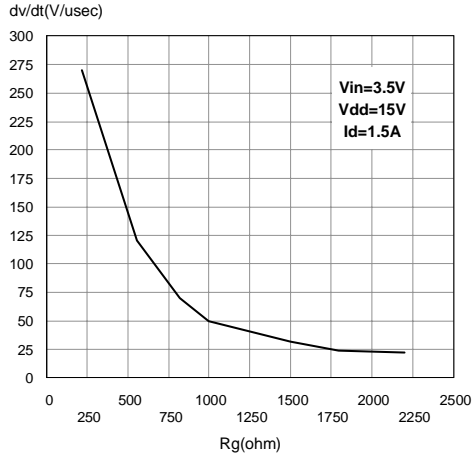


Turn off drain source voltage slope

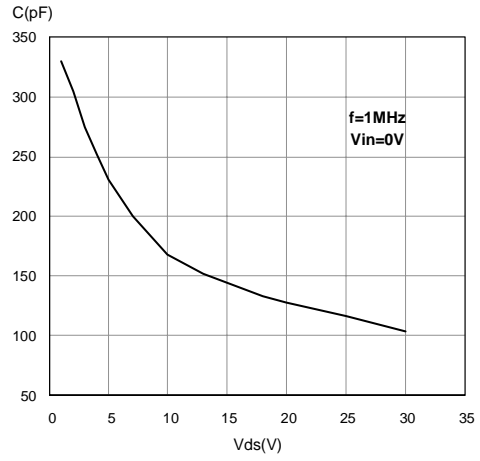


# VNS3NV04D

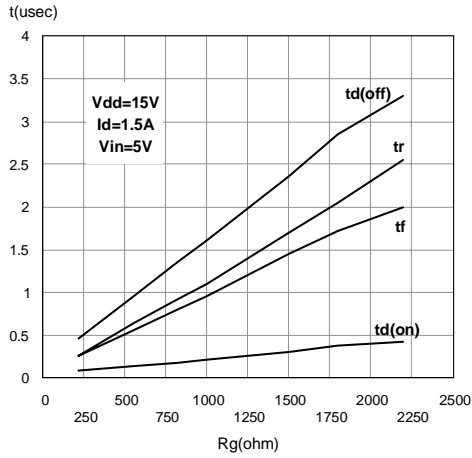
## Turn Off Drain-Source Voltage Slope



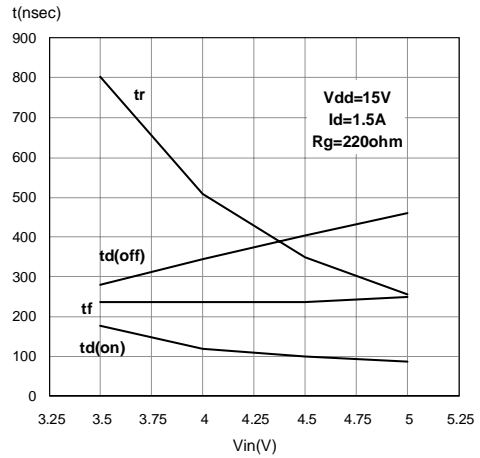
## Capacitance Variations



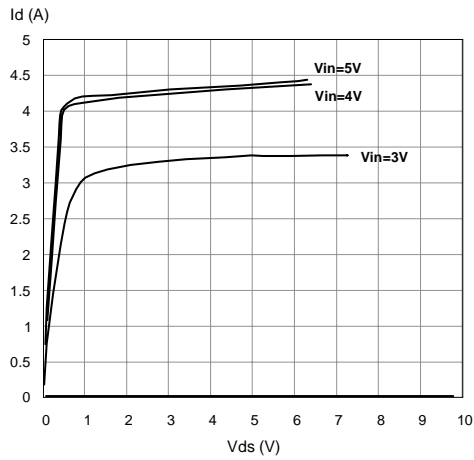
## Switching Time Resistive Load



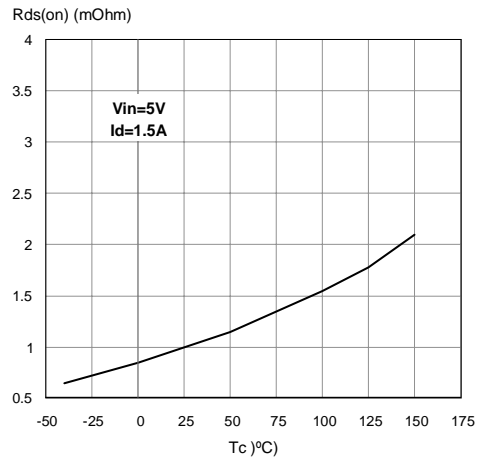
## Switching Time Resistive Load



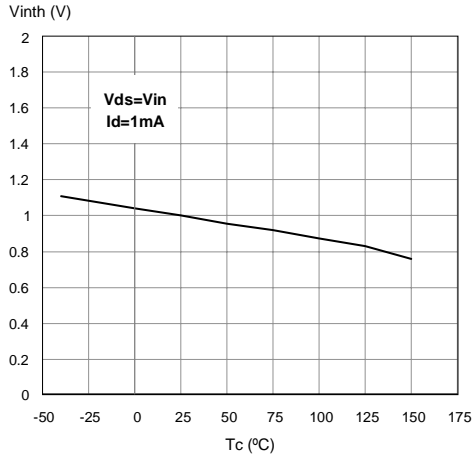
## Output Characteristics



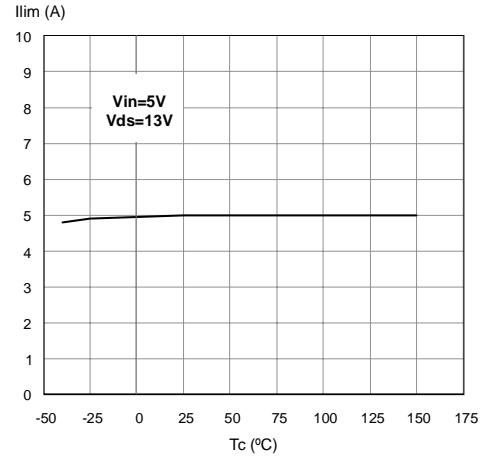
## Normalized On Resistance Vs. Temperature



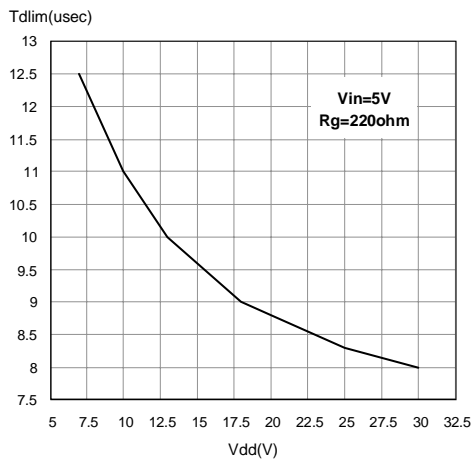
Normalized Input Threshold Voltage Vs. Junction Temperature



Normalized Current Limit Vs. Junction Temperature

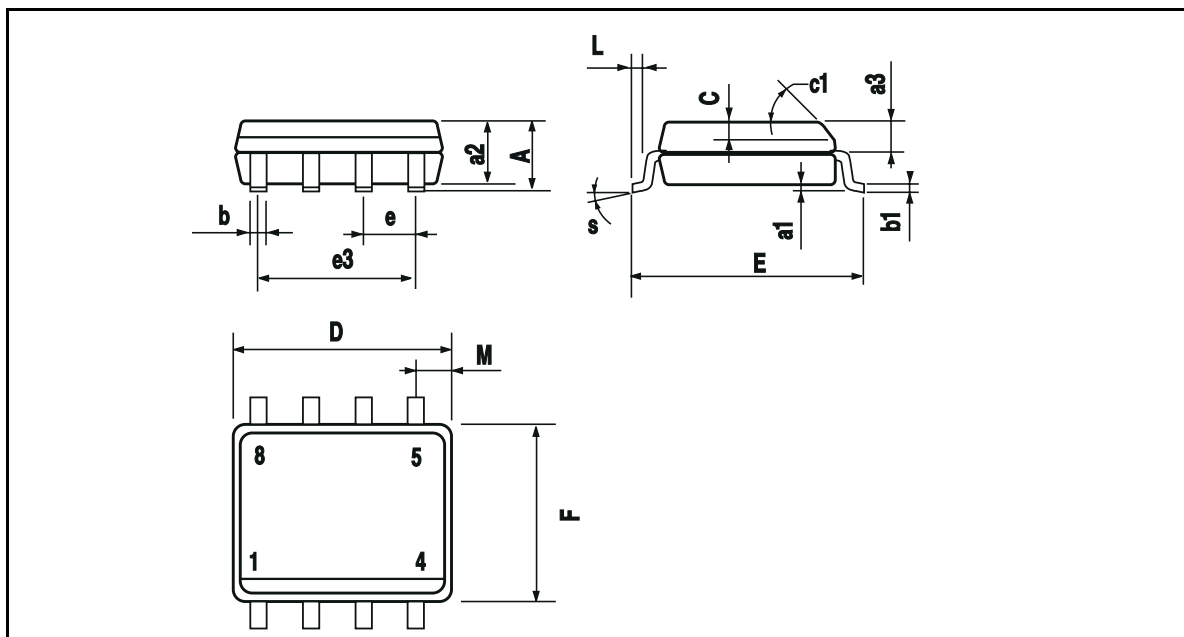


Step Response Current Limit

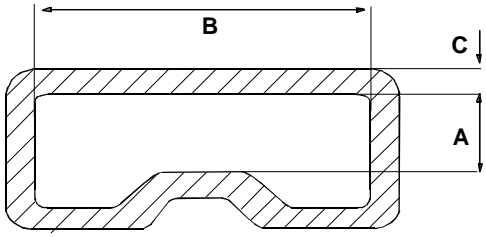


**SO-8 MECHANICAL DATA**

DIM.	mm.			inch		
	MIN.	TYP.	MAX.	MIN.	TYP.	MAX.
A			1.75			0.068
a1	0.1		0.25	0.003		0.009
a2			1.65			0.064
a3	0.65		0.85	0.025		0.033
b	0.35		0.48	0.013		0.018
b1	0.19		0.25	0.007		0.010
C	0.25		0.5	0.010		0.019
c1	45 (typ.)					
D	4.8		5.0	0.188		0.196
E	5.8		6.2	0.228		0.244
e		1.27			0.050	
e3		3.81			0.150	
F	3.8		4.0	0.14		0.157
L	0.4		1.27	0.015		0.050
M			0.6			0.023
F	8 (max.)					



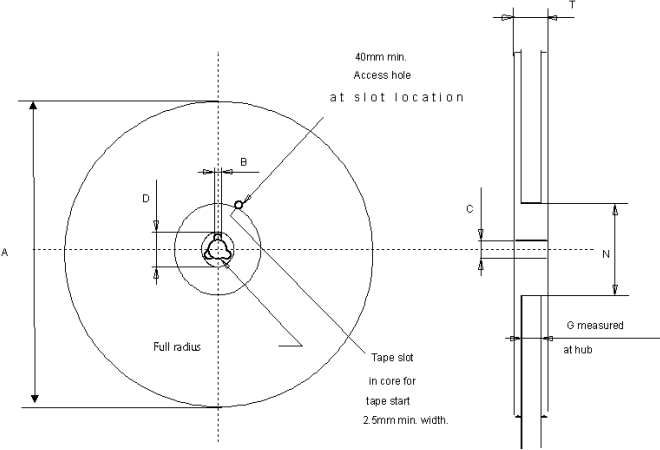
**SO-8 TUBE SHIPMENT (no suffix)**



<b>Base Q.ty</b>	100
<b>Bulk Q.ty</b>	2000
<b>Tube length (± 0.5)</b>	532
<b>A</b>	3.2
<b>B</b>	6
<b>C (± 0.1)</b>	0.6

All dimensions are in mm.

**TAPE AND REEL SHIPMENT (suffix "13TR")**



<b>Base Q.ty</b>	2500
<b>Bulk Q.ty</b>	2500
<b>A (max)</b>	330
<b>B (min)</b>	1.5
<b>C (± 0.2)</b>	13
<b>F</b>	20.2
<b>G (+ 2 / -0)</b>	12.4
<b>N (min)</b>	60
<b>T (max)</b>	18.4

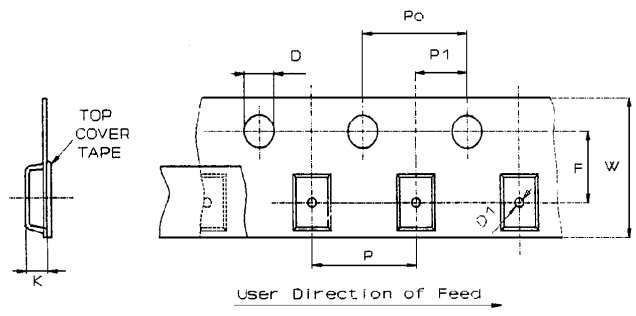
All dimensions are in mm.

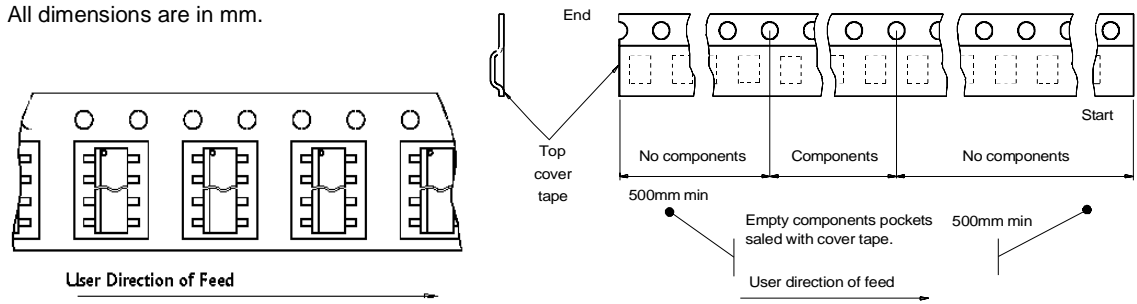
**TAPE DIMENSIONS**

According to Electronic Industries Association (EIA) Standard 481 rev. A, Feb 1986

<b>Tape width</b>	<b>W</b>	12
<b>Tape Hole Spacing</b>	<b>P0 (± 0.1)</b>	4
<b>Component Spacing</b>	<b>P</b>	8
<b>Hole Diameter</b>	<b>D (± 0.1/-0)</b>	1.5
<b>Hole Diameter</b>	<b>D1 (min)</b>	1.5
<b>Hole Position</b>	<b>F (± 0.05)</b>	5.5
<b>Compartment Depth</b>	<b>K (max)</b>	4.5
<b>Hole Spacing</b>	<b>P1 (± 0.1)</b>	2



All dimensions are in mm.



Information furnished is believed to be accurate and reliable. However, STMicroelectronics assumes no responsibility for the consequences of use of such information nor for any infringement of patents or other rights of third parties which may result from its use. No license is granted by implication or otherwise under any patent or patent rights of STMicroelectronics. Specifications mentioned in this publication are subject to change without notice. This publication supersedes and replaces all information previously supplied. STMicroelectronics products are not authorized for use as critical components in life support devices or systems without express written approval of STMicroelectronics.  
The ST logo is a trademark of STMicroelectronics

© 2003 STMicroelectronics - Printed in ITALY- All Rights Reserved.

STMicroelectronics GROUP OF COMPANIES

Australia - Brazil - Canada - China - Finland - France - Germany - Hong Kong - India - Israel - Italy - Japan - Malaysia -  
Malta - Morocco - Singapore - Spain - Sweden - Switzerland - United Kingdom - U.S.A.

<http://www.st.com>