

POWER SCHOTTKY RECTIFIER

MAIN PRODUCT CHARACTERISTICS

$I_{F(AV)}$	2 x 10 A
V_{RRM}	45 V
$T_j(\text{max})$	175 °C
$V_F(\text{max})$	0.57 V

FEATURES AND BENEFITS

- VERY SMALL CONDUCTION LOSSES
- NEGLIGIBLE SWITCHING LOSSES
- EXTREMELY FAST SWITCHING
- INSULATED PACKAGE: ISOWATT220AB
Insulating voltage = 2000V DC
Capacitance = 12pF

DESCRIPTION

Dual center tap Schottky rectifier suited for Switch-Mode Power Supply and high frequency DC to DC converters.

Packaged either in TO-220AB, ISOWATT220AB or D²PAK, this device is especially intended for use in low voltage, high frequency inverters, free wheeling and polarity protection applications.

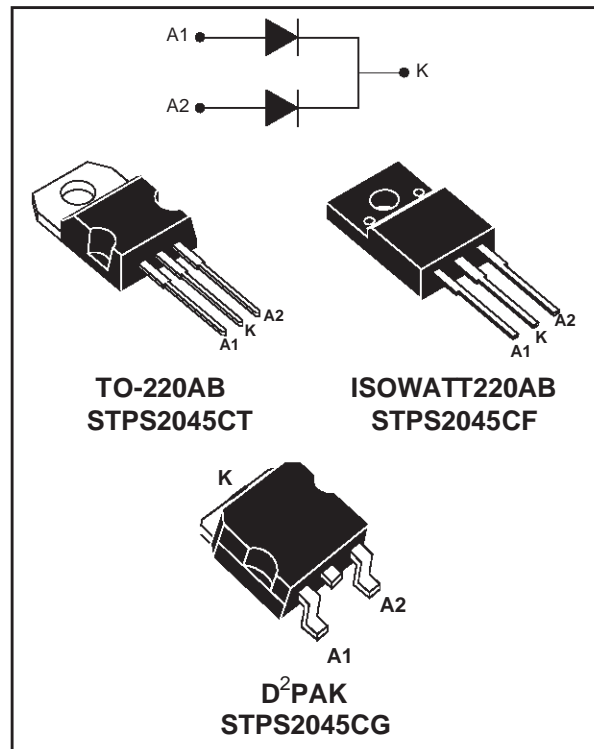

ABSOLUTE RATINGS (limiting values, per diode)

Symbol	Parameter			Value	Unit	
V_{RRM}	Repetitive peak reverse voltage			45	V	
$I_{F(RMS)}$	RMS forward current			30	A	
$I_{F(AV)}$	Average forward current $\delta = 0.5$	TO-220AB	$T_c = 155^\circ\text{C}$	Per diode	10	A
		D ² PAK				
		ISOWATT220AB	$T_c = 125^\circ\text{C}$	Per device	20	
I_{FSM}	Surge non repetitive forward current		$t_p = 10 \text{ ms}$ sinusoidal	180	A	
I_{RRM}	Repetitive peak reverse current		$t_p = 2 \mu\text{s}$ square $F = 1 \text{ kHz}$	1	A	
I_{RSM}	Non repetitive peak reverse current		$t_p = 100 \text{ ms}$ square	2	A	
T_{stg}	Storage temperature range			-65 to +175	°C	
T_j	Maximum operating junction temperature*			175	°C	
dV/dt	Critical rate of rise of reverse voltage			10000	V/ μs	

* : $\frac{dP_{tot}}{dT_j} < \frac{1}{R_{th(j-a)}}$ thermal runaway condition for a diode on its own heatsink

STPS2045CT/CF/CG

THERMAL RESISTANCES

Symbol	Parameter		Value	Unit	
R _{th(j-c)}	Junction to case	TO-220AB/ D ² PAK	Per diode Total	2.2 1.3	°C/W
		ISOWATT220AB	Per diode Total	4.5 3.5	
R _{th(c)}		TO-220AB/ D ² PAK	Coupling	0.3	
		ISOWATT220AB		2.5	

When the diodes 1 and 2 are used simultaneously:

$$\Delta T_j(\text{diode 1}) = P(\text{diode 1}) \times R_{th(j-c)}(\text{per diode}) + P(\text{diode 2}) \times R_{th(c)}$$

STATIC ELECTRICAL CHARACTERISTICS (Per diode)

Symbol	Parameter	Tests Conditions		Min.	Typ.	Max.	Unit
I _R *	Reverse leakage current	T _j = 25°C	V _R = V _{RRM}			100	μA
		T _j = 125°C			7	15	mA
V _F *	Forward voltage drop	T _j = 125°C	I _F = 10 A		0.5	0.57	V
		T _j = 25°C	I _F = 20 A			0.84	
		T _j = 125°C	I _F = 20 A		0.65	0.72	

Pulse test : * t_p = 380 μs, δ < 2%

To evaluate the conduction losses use the following equation :

$$P = 0.42 \times I_{F(AV)} + 0.015 I_{F(RMS)}^2$$

Fig. 1: Average forward power dissipation versus average forward current (per diode).

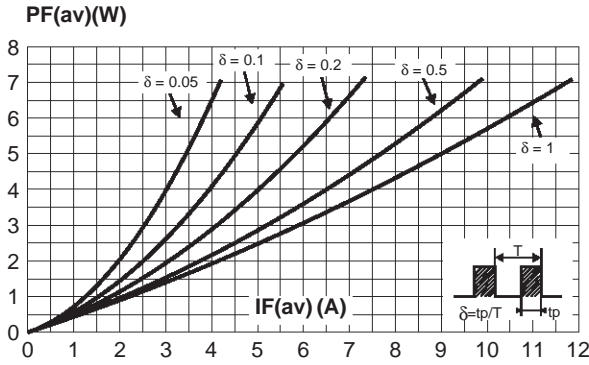

Fig. 2: Average current versus ambient temperature ($\delta=0.5$, per diode).

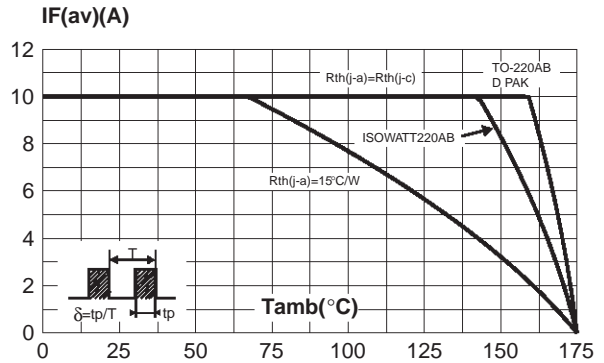

Fig. 3-1: Non repetitive surge peak forward current versus overload duration (maximum values, per diode) (TO-220AB and D²PAK).

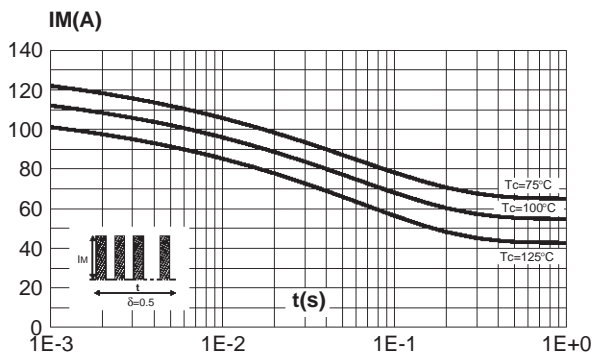

Fig. 3-2: Non repetitive surge peak forward current versus overload duration (maximum values, per diode) (ISOWATT220AB).

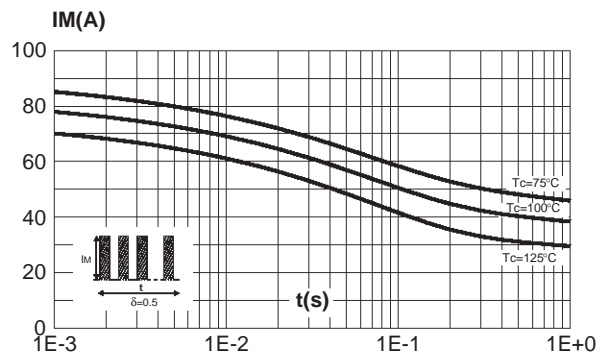

Fig. 4-1: Relative variation of thermal transient impedance junction to case versus pulse duration (TO-220AB and D²PAK).

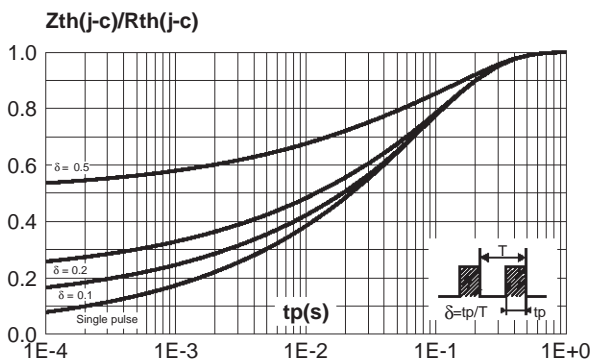

Fig. 4-2: Relative variation of thermal transient impedance junction to case versus pulse duration (ISOWATT220AB).

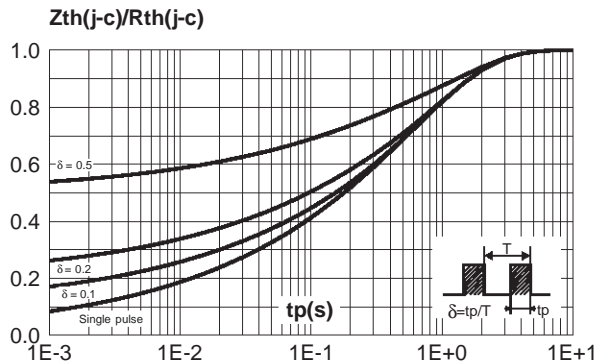

Fig. 5: Reverse leakage current versus reverse voltage applied (typical values, per diode).

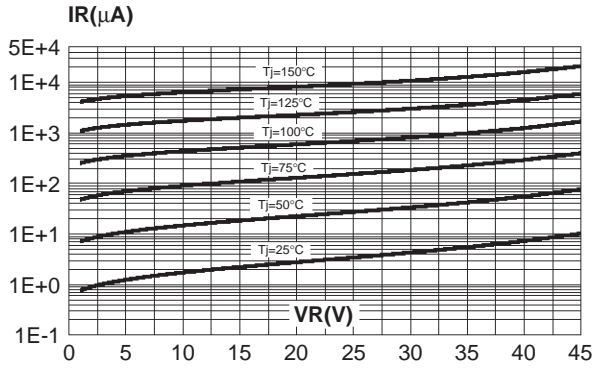

Fig. 6: Junction capacitance versus reverse voltage applied (typical values, per diode).

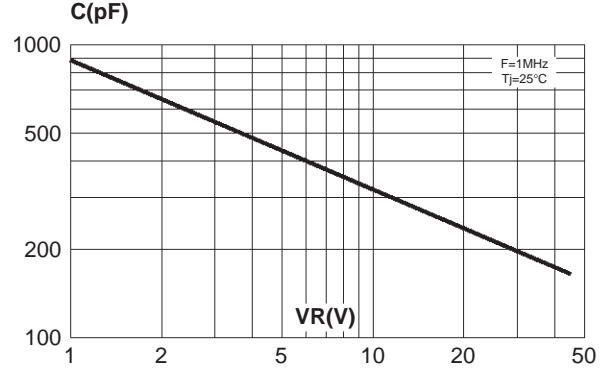

Fig. 7: Forward voltage drop versus forward current (maximum values, per diode).

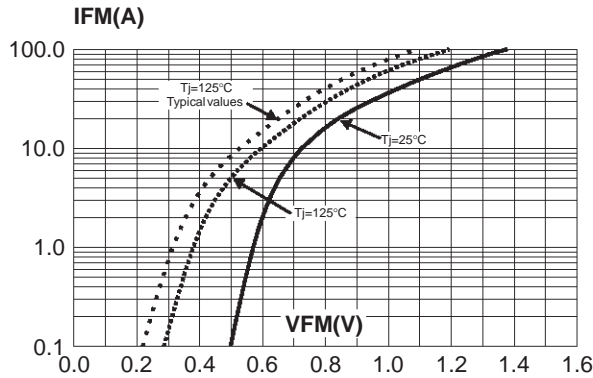
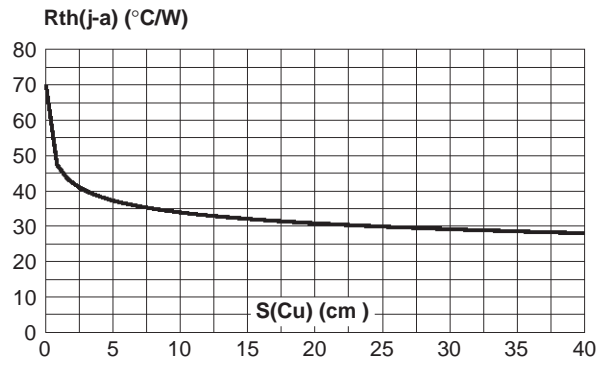
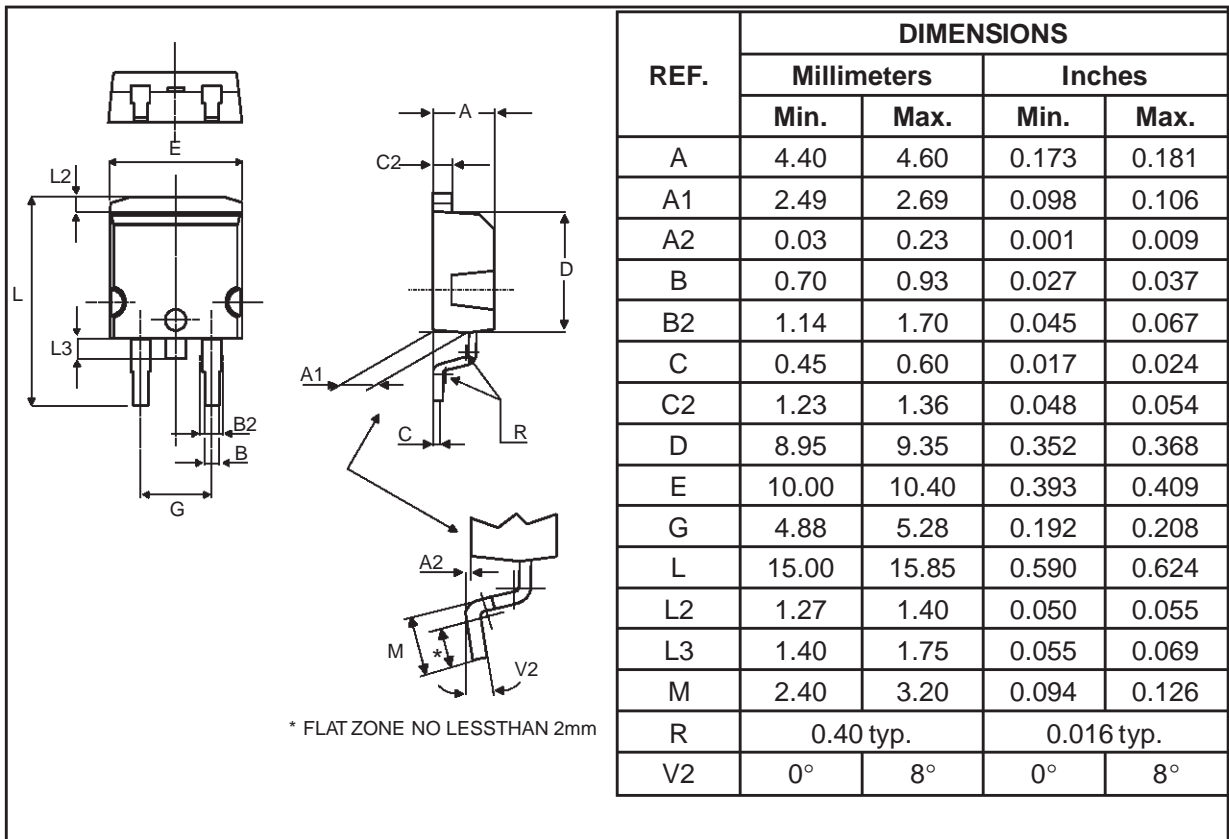

Fig. 8: Thermal resistance junction to ambient versus copper surface under tab (Epoxy printed circuit board, copper thickness: $35\mu m$).



PACKAGE MECHANICAL DATA
D²PAK



FOOTPRINT DIMENSIONS (in millimeters)

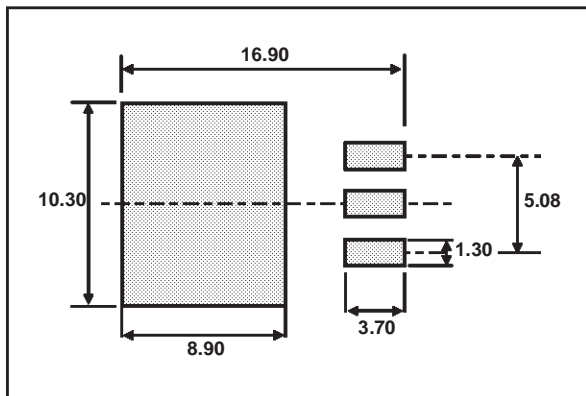

STPS2045CT/CF/CG

PACKAGE MECHANICAL DATA
TO-220AB

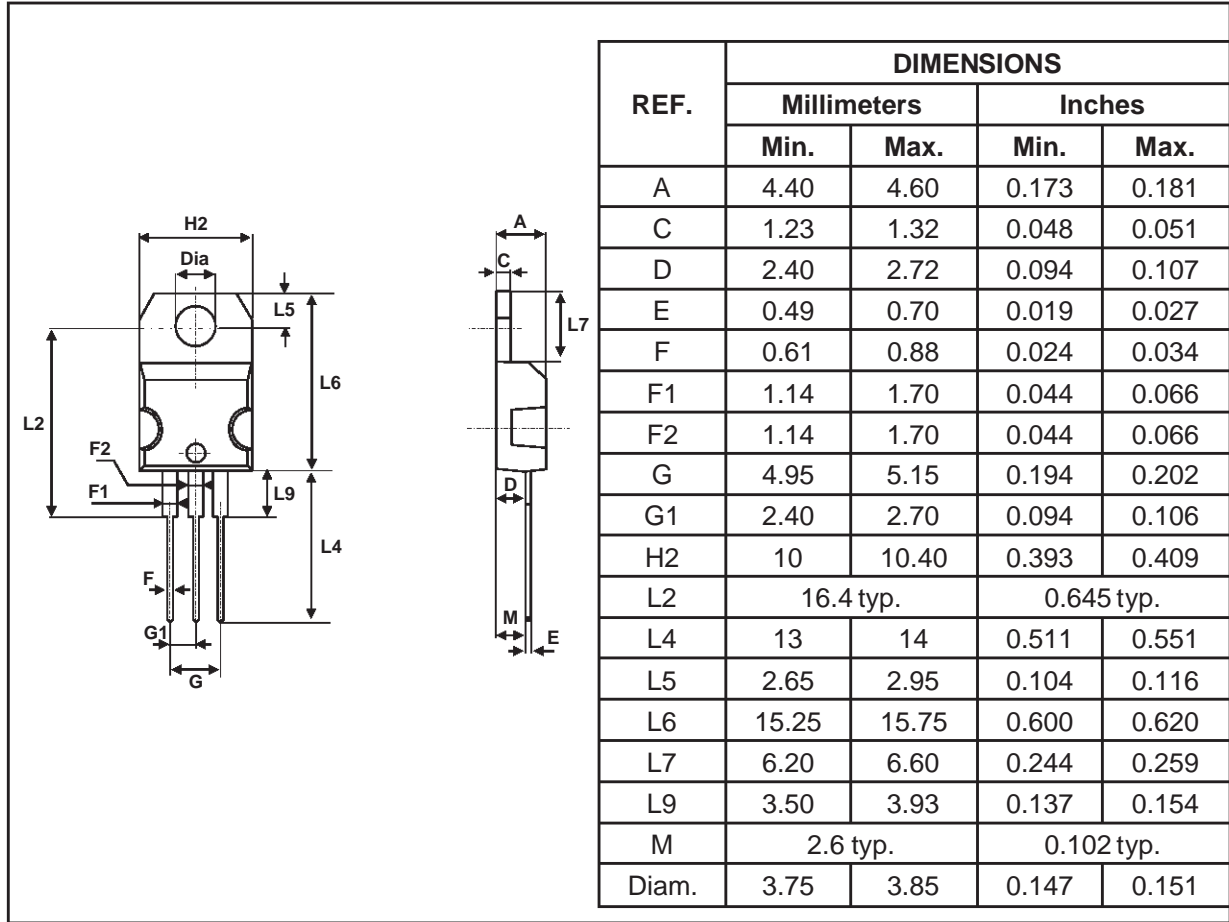

PACKAGE MECHANICAL DATA
 ISOWATT220AB

REF.	DIMENSIONS			
	Millimeters		Inches	
	Min.	Max.	Min.	Max.
A	4.40	4.60	0.173	0.181
B	2.50	2.70	0.098	0.106
D	2.50	2.75	0.098	0.108
E	0.40	0.70	0.016	0.028
F	0.75	1.00	0.030	0.039
F1	1.15	1.70	0.045	0.067
F2	1.15	1.70	0.045	0.067
G	4.95	5.20	0.195	0.205
G1	2.40	2.70	0.094	0.106
H	10.00	10.40	0.394	0.409
L2	16.00 typ.		0.630 typ.	
L3	28.60	30.60	1.125	1.205
L4	9.80	10.60	0.386	0.417
L6	15.90	16.40	0.626	0.646
L7	9.00	9.30	0.354	0.366
Diam	3.00	3.20	0.118	0.126

Type	Marking	Package	Weight	Base qty	Delivery mode
STPS2045CT	STPS2045CT	TO-220AB	2.25 g.	50	Tube
STPS2045CF	STPS2045CF	ISOWATT220AB	2.08 g.	50	Tube
STPS2045CG	STPS2045CG	D ² PAK	1.48 g.	50	Tube
STPS2045CG-TR	STPS2045CG	D ² PAK	1.48 g.	1000	Tape & reel

- Cooling method: by conduction (C)
- Recommended torque value: 0.55 N.m.
- Maximum torque value: 0.7 N.m.
- Epoxy meets UL94,V0

Information furnished is believed to be accurate and reliable. However, STMicroelectronics assumes no responsibility for the consequences of use of such information nor for any infringement of patents or other rights of third parties which may result from its use. No license is granted by implication or otherwise under any patent or patent rights of STMicroelectronics. Specifications mentioned in this publication are subject to change without notice. This publication supersedes and replaces all information previously supplied. STMicroelectronics products are not authorized for use as critical components in life support devices or systems without express written approval of STMicroelectronics.

The ST logo is a registered trademark of STMicroelectronics

© 1999 STMicroelectronics - Printed in Italy - All rights reserved.

STMicroelectronics GROUP OF COMPANIES

Australia - Brazil - China - Finland - France - Germany - Hong Kong - India - Italy - Japan - Malaysia
 Malta - Morocco - Singapore - Spain - Sweden - Switzerland - United Kingdom - U.S.A.

<http://www.st.com>