



# STPS15L25D/G

## LOW DROP POWER SCHOTTKY RECTIFIER

### MAIN PRODUCT CHARACTERISTICS

$I_{F(AV)}$	15 A
$V_{RRM}$	25 V
$T_j(max)$	150 °C
$V_F(max)$	0.35 V

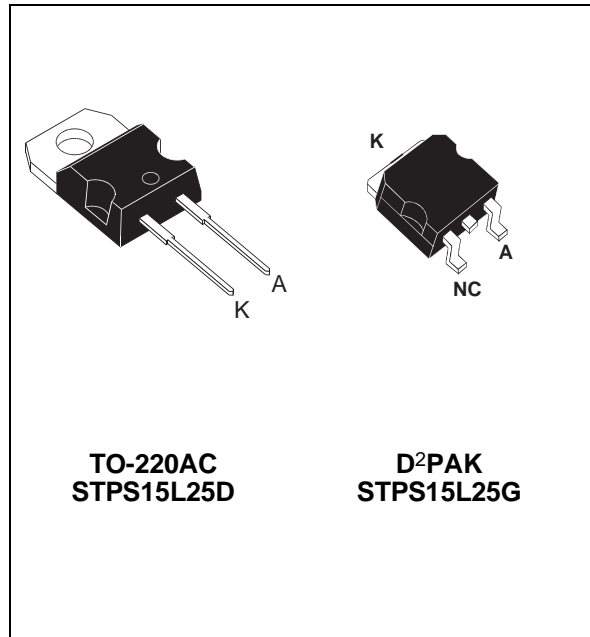
### FEATURES

- VERY LOW FORWARD VOLTAGE DROP FOR LESS POWER DISSIPATION AND REDUCED HEATSINK
- OPTIMIZED CONDUCTION/REVERSE LOSSES TRADE-OFF WHICH MEANS THE HIGHEST EFFICIENCY IN THE APPLICATIONS

### DESCRIPTION

Single Schottky rectifier suited for Switched Mode Power Supplies and high frequency DC to DC converters (VRMs).

Packaged in TO-220AC or D<sup>2</sup>PAK, this device is especially intended for use as a Rectifier at the secondary of 3.3V SMPS and DC/DC units.



TO-220AC  
STPS15L25D

D<sup>2</sup>PAK  
STPS15L25G

### ABSOLUTE RATINGS (limiting values)

Symbol	Parameter		Value	Unit
$V_{RRM}$	Repetitive peak reverse voltage		25	V
$I_{F(RMS)}$	RMS forward current		30	A
$I_{F(AV)}$	Average forward current	$T_c = 145^\circ\text{C} \delta = 0.5$	15	A
$I_{FSM}$	Surge non repetitive forward current	$t_p = 10\text{ms}$ Sinusoidal	250	A
$I_{RRM}$	Repetitive peak reverse current	$t_p = 2\mu\text{s}$ square $F = 1\text{kHz}$	1	A
$I_{RSM}$	Non repetitive peak reverse current	$t_p = 100\mu\text{s}$ square	4	A
$T_{stg}$	Storage temperature range		- 65 to + 150	°C
$T_j$	Maximum operating junction temperature *		150	°C
$dV/dt$	Critical rate of rise of reverse voltage		10000	V/ $\mu\text{s}$

\* :  $\frac{dP_{tot}}{dT_j} < \frac{1}{R_{th(j-a)}}$  thermal runaway condition for a diode on its own heatsink

## STPS15L25D/G

### THERMAL RESISTANCES

Symbol	Parameter	Value	Unit
$R_{th(j-c)}$	Junction to case	1	$^{\circ}\text{C}/\text{W}$

### STATIC ELECTRICAL CHARACTERISTICS

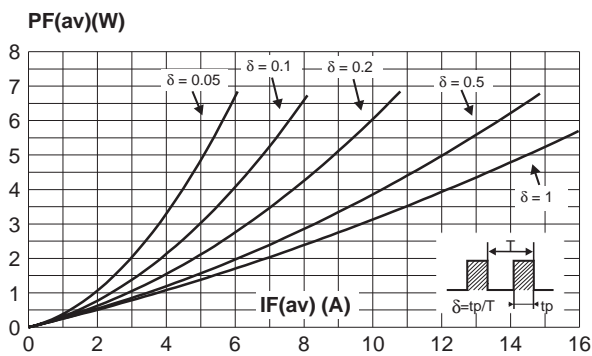
Symbol	Parameters	Test conditions		Min.	Typ.	Max.	Unit
$I_R$ *	Reverse leakage current	$T_j = 25^{\circ}\text{C}$	$V_R = V_{RRM}$			1.3	mA
		$T_j = 125^{\circ}\text{C}$			225	450	mA
$V_F$ *	Forward voltage drop	$T_j = 25^{\circ}\text{C}$	$I_F = 15\text{A}$			0.46	V
		$T_j = 125^{\circ}\text{C}$	$I_F = 15\text{A}$		0.3	0.35	
		$T_j = 25^{\circ}\text{C}$	$I_F = 30\text{A}$			0.56	
		$T_j = 125^{\circ}\text{C}$	$I_F = 30\text{A}$		0.41	0.46	

Pulse test : \*  $t_p = 380 \mu\text{s}$ ,  $\delta < 2\%$

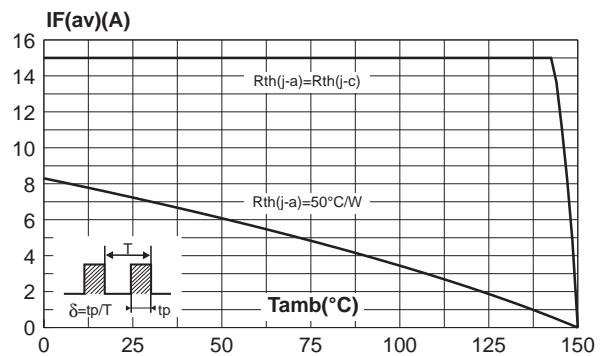
To evaluate the maximum conduction losses use the following equation :

$$P = 0.24 \times I_{F(AV)} + 0.0073 I_{F(RMS)}^2$$

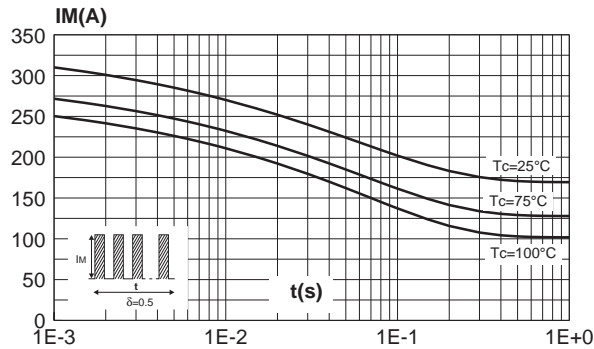
**Fig.1** : Average forward power dissipation versus average forward current.



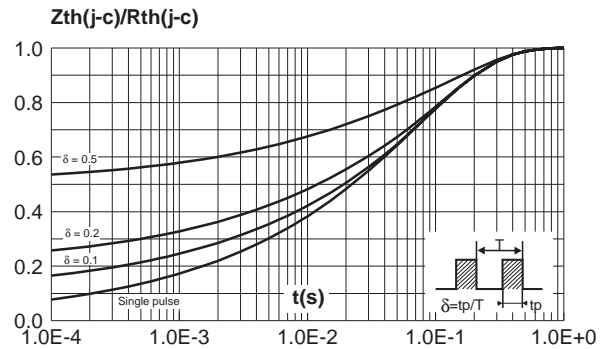
**Fig.2** : Average forward current versus ambient temperature ( $\delta = 0.5$ ).



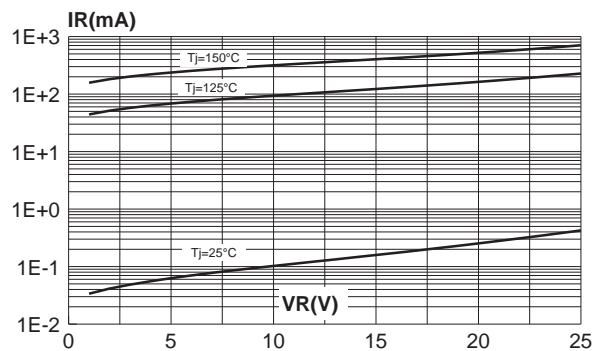
**Fig.3** : Non repetitive surge peak forward current versus overload duration (maximum values).



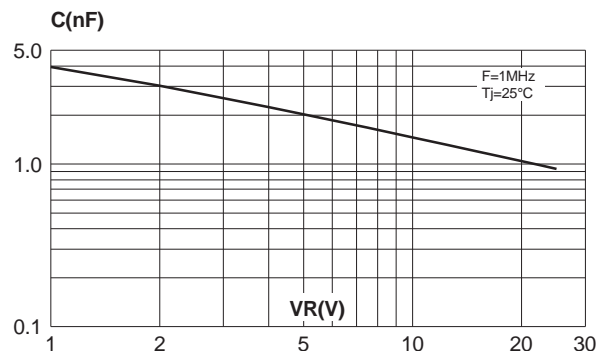
**Fig.4** : Relative variation of thermal impedance junction to case versus pulse duration.



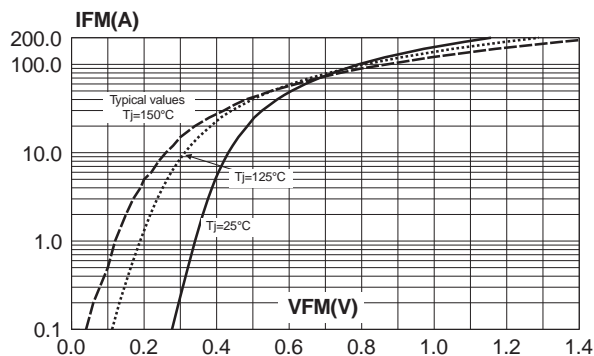
**Fig.5** : Reverse leakage current versus reverse voltage applied (typical values).



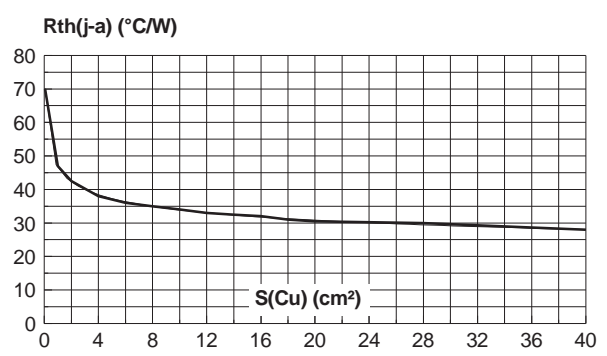
**Fig.6** : Junction capacitance versus reverse voltage applied (typical values).



**Fig.7** : Forward voltage drop versus forward current (maximum values).

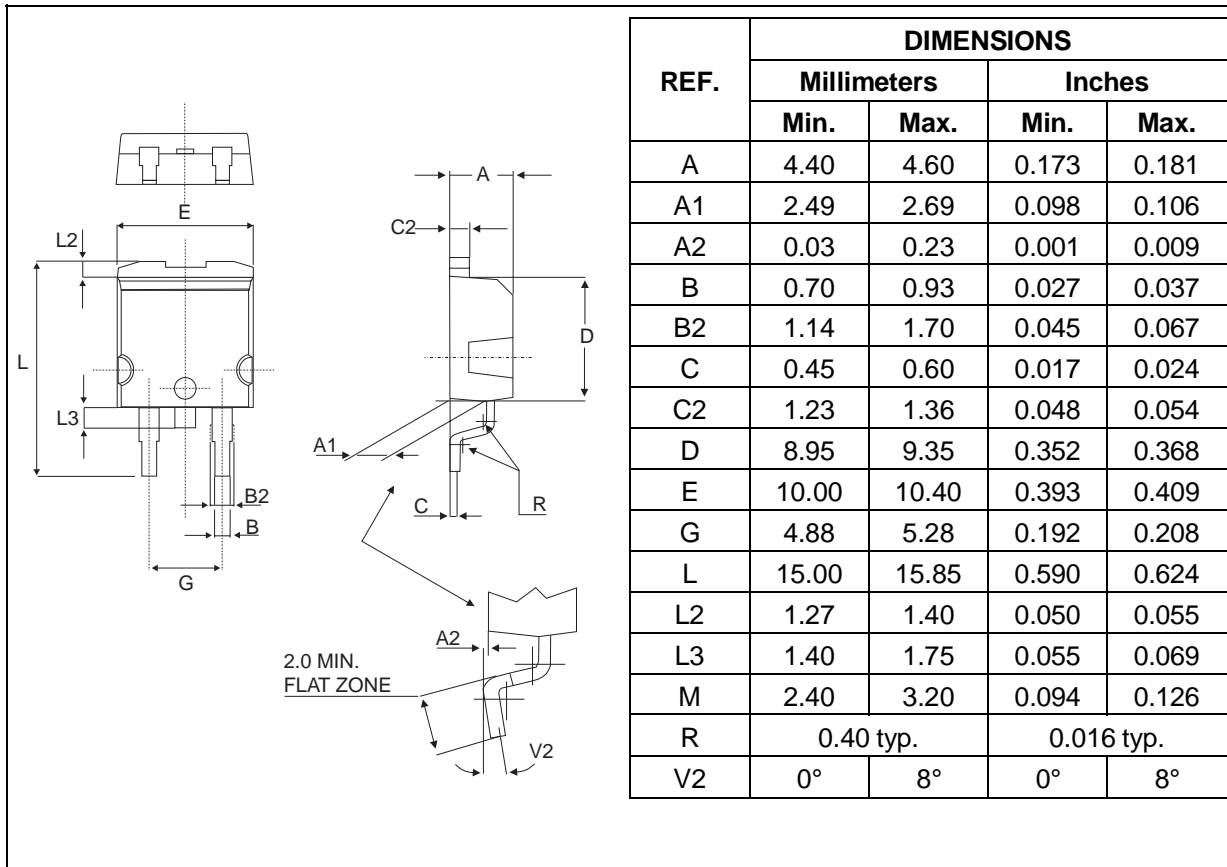


**Fig.8** : Thermal resistance junction to ambient versus copper surface under tab (Epoxy printed circuit board FR4, copper thickness : 35  $\mu\text{m}$ ). (STPS15L25G only)

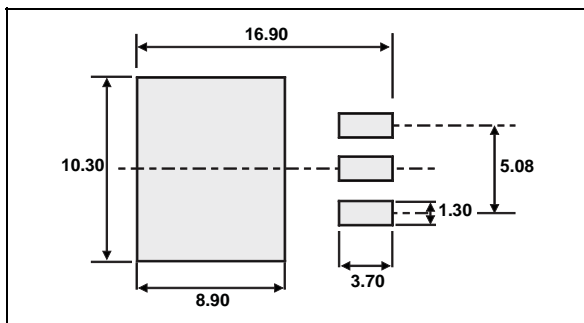


# STPS15L25D/G

## PACKAGE MECHANICAL DATA D<sup>2</sup>PAK



### FOOT PRINT DIMENSIONS (in millimeters)



- Cooling method: by conduction (method C)

**PACKAGE MECHANICAL DATA**  
 TO-220AC

REF.	DIMENSIONS			
	Millimeters		Inches	
	Min.	Max.	Min.	Max.
A	4.40	4.60	0.173	0.181
C	1.23	1.32	0.048	0.051
D	2.40	2.72	0.094	0.107
E	0.49	0.70	0.019	0.027
F	0.61	0.88	0.024	0.034
F1	1.14	1.70	0.044	0.066
G	4.95	5.15	0.194	0.202
H2	10.00	10.40	0.393	0.409
L2	16.40 typ.		0.645 typ.	
L4	13.00	14.00	0.511	0.551
L5	2.65	2.95	0.104	0.116
L6	15.25	15.75	0.600	0.620
L7	6.20	6.60	0.244	0.259
L9	3.50	3.93	0.137	0.154
M	2.6 typ.		0.102 typ.	
Diam. I	3.75	3.85	0.147	0.151

- Cooling method : C
- Recommended torque value : 0.55 m.N
- Maximum torque value : 0.70 m.N

Ordering type	Marking	Package	Weight	Base qty	Delivery mode
STPS15L25D	STPS15L25D	TO-220AC	1.86g	50	Tube
STPS15L25G	STPS15L25G	D <sup>2</sup> PAK	1.48g	50	Tube
STPS15L25G-TR	STPS15L25G	D <sup>2</sup> PAK	1.48g	1000	Tape & reel

- Epoxy meets UL94,V0

Information furnished is believed to be accurate and reliable. However, STMicroelectronics assumes no responsibility for the consequences of use of such information nor for any infringement of patents or other rights of third parties which may result from its use. No license is granted by implication or otherwise under any patent or patent rights of STMicroelectronics. Specifications mentioned in this publication are subject to change without notice. This publication supersedes and replaces all information previously supplied.

STMicroelectronics products are not authorized for use as critical components in life support devices or systems without express written approval of STMicroelectronics.

The ST logo is a registered trademark of STMicroelectronics

© 1999 STMicroelectronics - Printed in Italy - All rights reserved.

STMicroelectronics GROUP OF COMPANIES

Australia - Brazil - China - Finland - France - Germany - Hong Kong - India - Italy - Japan - Malaysia  
 Malta - Morocco - Singapore - Spain - Sweden - Switzerland - United Kingdom - U.S.A.

<http://www.st.com>

