

Variable Capacitance Diode

Description

The 1T412 is a variable capacitance diode designed for electronic tuning of BS tuners using a super-small-miniature flat package (SSVC).

Features

- Super-small-miniature flat package
- Low series resistance: 1.8 Ω Max. (f=470 MHz)
- Large capacitance ratio: 5.7 Typ. (C₂/C₂₅)
- Small leakage current: 10 nA Max. (V_R=28 V)
- Capacitance deviation in a matching group:
within 5 %

Applications

Electronic tuning of BS tuners

Structure

Silicon epitaxial planar type diode

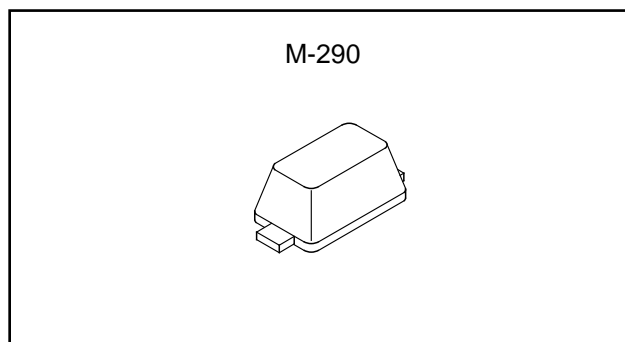

Absolute Maximum Ratings (Ta=25 °C)

- Reverse voltage V_R 30 V
- Peak reverse voltage V_{RM} 35 V
(R_L ≥ 10 k Ω)
- Operating temperature T_{opr} -20 to +75 °C
- Storage temperature T_{stg} -65 to +150 °C

Electrical Characteristics

(Ta=25 °C)

Item	Symbol	Conditions	Min.	Typ.	Max.	Unit
Reverse current	I _R	V _R =28 V			10	nA
Diode capacitance	C ₂	V _R =2 V, f=1 MHz	3.27		4.51	pF
	C ₂₅	V _R =25 V, f=1 MHz	0.57		0.77	pF
Capacitance ratio	C ₂ /C ₂₅		5.0	5.7		
Series resistance	r _s	V _R =1V, f=470 MHz		1.1	1.8	Ω
Capacitance deviation in a matching group	Δ C	V _R =2 to 25 V, f=1 MHz			5	%

Sony reserves the right to change products and specifications without prior notice. This information does not convey any license by any implication or otherwise under any patents or other right. Application circuits shown, if any, are typical examples illustrating the operation of the devices. Sony cannot assume responsibility for any problems arising out of the use of these circuits.

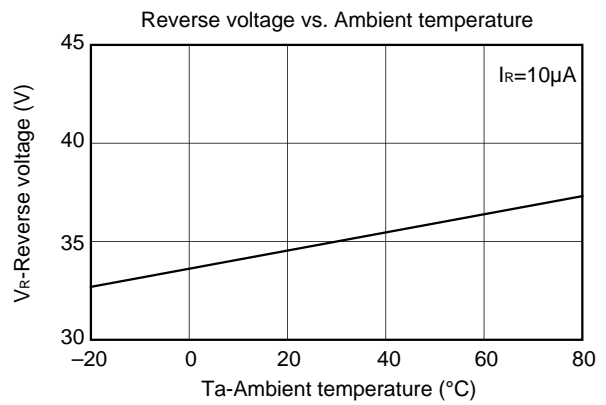
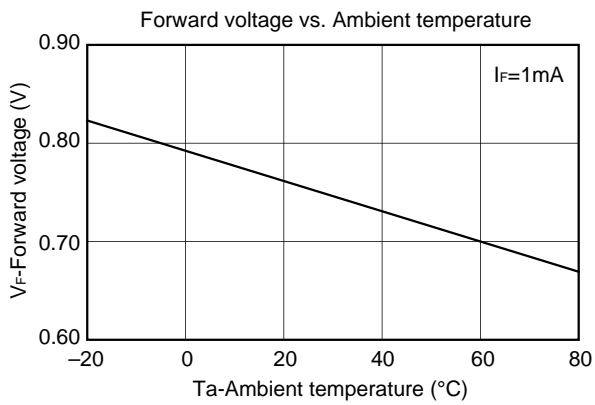
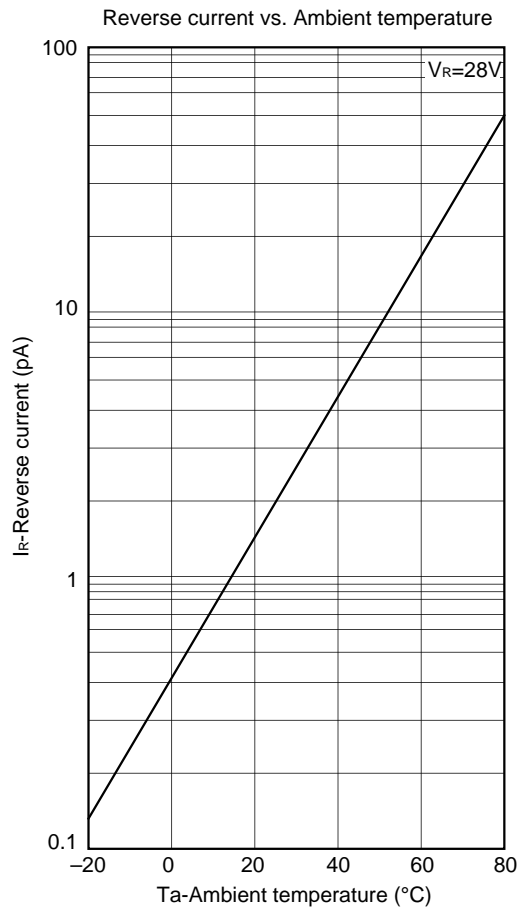
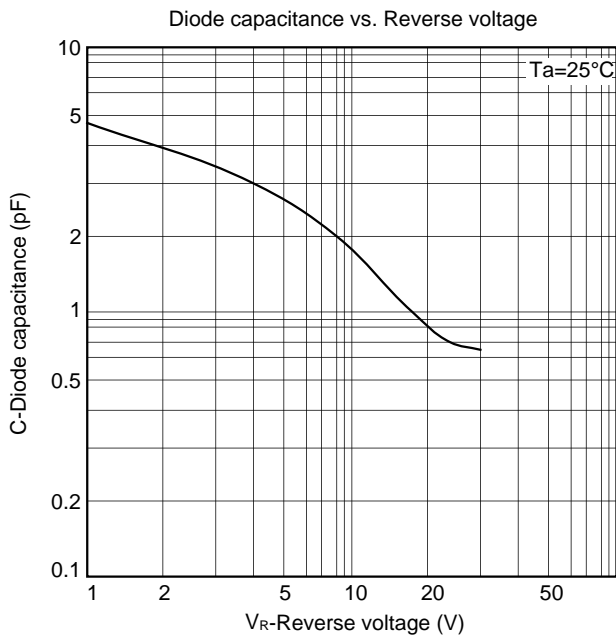

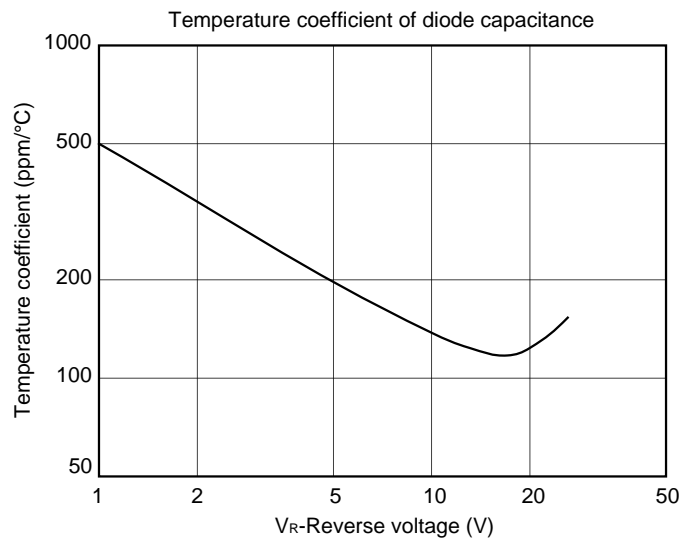
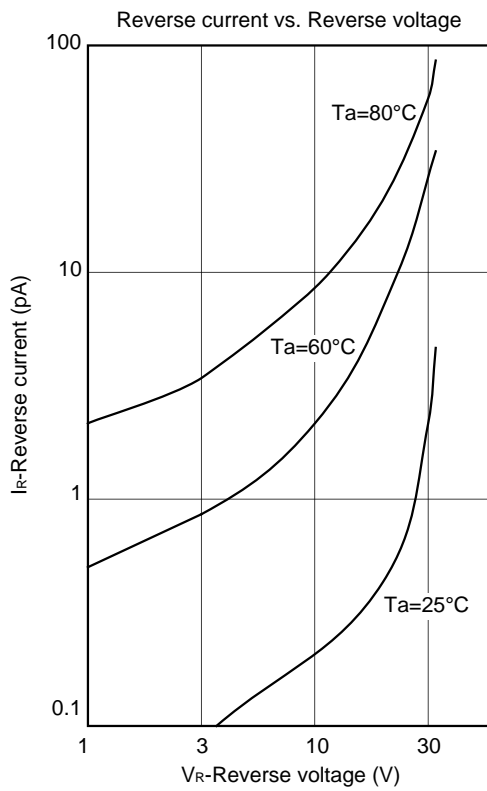
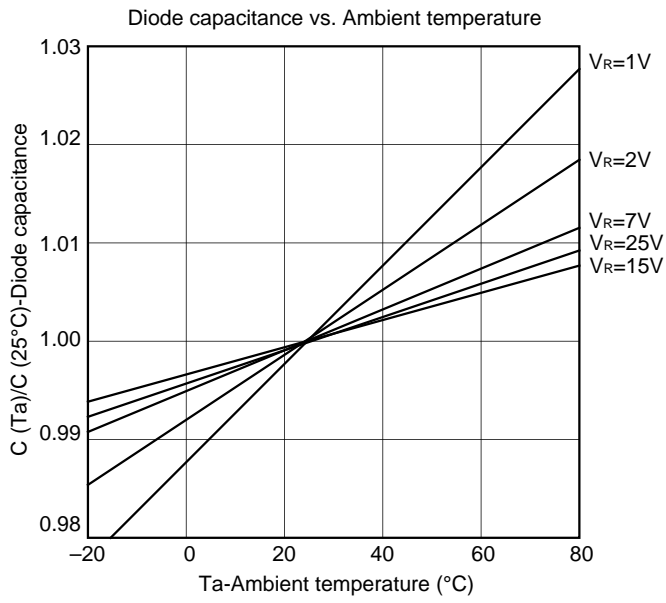

Package Outline Unit : mm

M-290

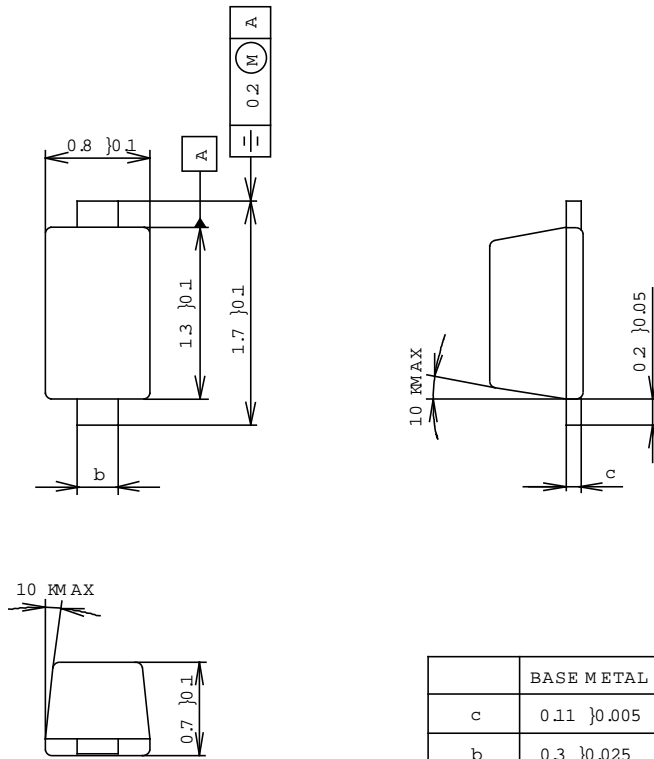

	BASE METAL	WITH PLATING
c	0.11 ± 0.005	0.11 $\begin{matrix} 0.05 \\ 0.01 \end{matrix}$
b	0.3 ± 0.025	0.3 $\begin{matrix} 0.05 \\ 0.02 \end{matrix}$

SONY CODE	M-290
EIAJ CODE	—
JEDEC CODE	—

PACKAGE MATERIAL	EPOXY RESIN
LEAD TREATMENT	SOLDER PLATING
LEAD MATERIAL	COPPER
PACKAGE WEIGHT	0.002g

Mark

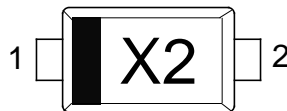

1 : Cathode

2 : Anode