

Variable Capacitance Diode

Description

The 1T405A is a variable capacitance diode designed for electronic tuning of wide-band CATV tuners using a super-small-miniature flat package (SSVC).

High capacitance ratio (C25/C28) is improved to support guard band.

Features

- Super-small-miniature flat package
- Low series resistance 0.85 Ω Max. (f=470 MHz)
- Large capacitance ratio 12.5 Typ. (C₂/C₂₅)
1.03 Min. (C₂₅/C₂₈)
- Small leakage current 10 nA Max. (V_R=28 V)
- Capacitance deviation within 2 %

Applications

Electronic tuning of VHF band and wide-band CATV tuners

Structure

Silicon epitaxial planar type diode

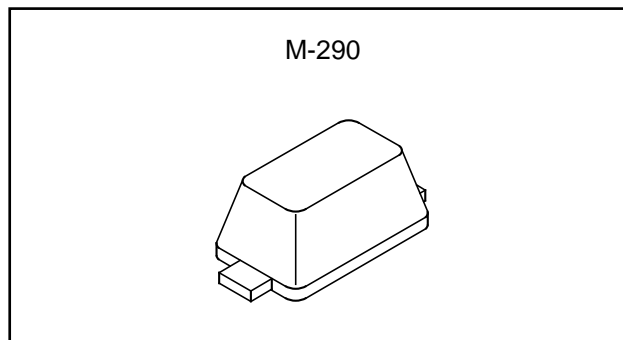

Absolute Maximum Ratings (Ta=25 °C)

- | | | | |
|-------------------------|----------------|-------------|----|
| • Reverse voltage | V _R | 34 | V |
| • Operating temperature | Topr | -20 to +75 | °C |
| • Storage temperature | Tstg | -65 to +150 | °C |

Electrical Characteristics

(Ta=25 °C)

Item	Symbol	Conditions	Min.	Typ.	Max.	Unit
Reverse current	I _R	V _R =28 V			10	nA
Reverse voltage	V _R	I _R =1 μ A	34			V
Diode capacitance	C ₂	V _R =2 V, f=1 MHz	32.96		38.96	pF
	C ₂₅	V _R =25 V, f=1 MHz	2.53		2.96	pF
Capacitance ratio	C ₂ /C ₂₅		12.0	12.5		
	C ₂₅ /C ₂₈		1.03			
Series resistance	r _s	C _D =14 pF, f=470 MHz			0.85	Ω
Capacitance deviation in a matching group	Δ C	V _R =2 to 25 V, f=1 MHz			2	%

The continuous 20 pieces of Δ C are guaranteed.

Sony reserves the right to change products and specifications without prior notice. This information does not convey any license by any implication or otherwise under any patents or other right. Application circuits shown, if any, are typical examples illustrating the operation of the devices. Sony cannot assume responsibility for any problems arising out of the use of these circuits.

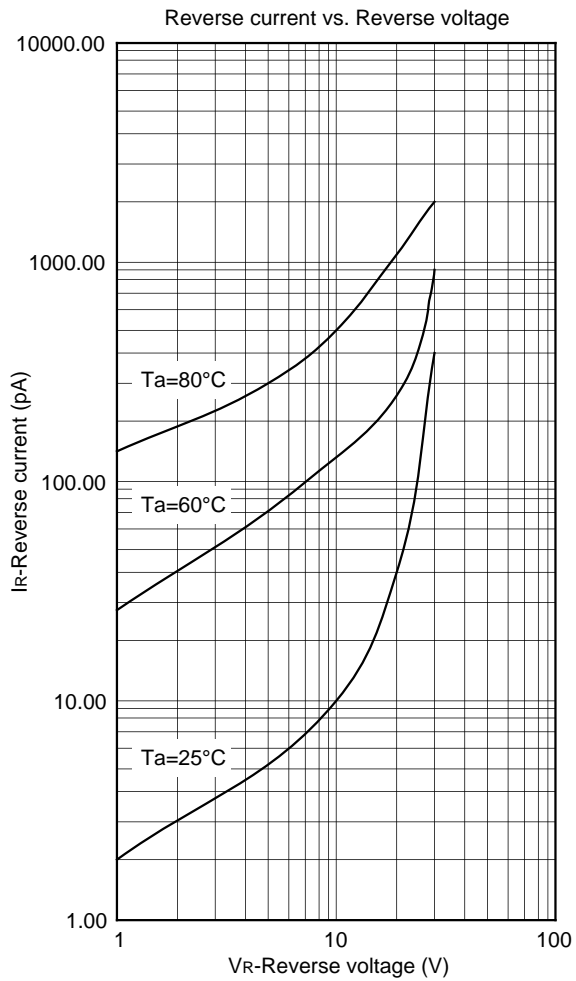
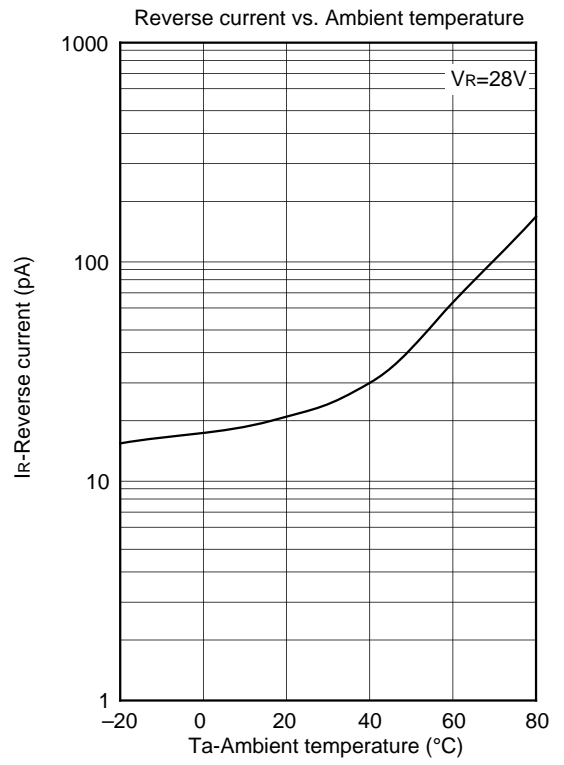
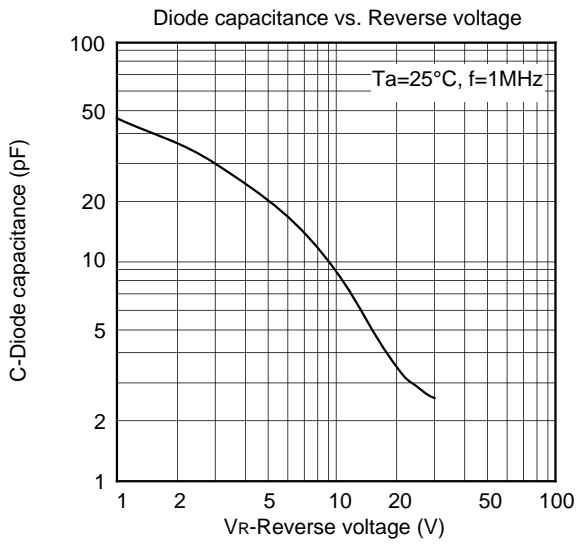

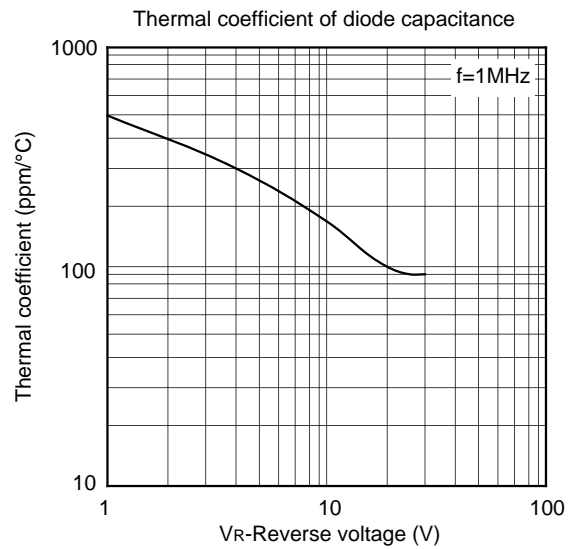
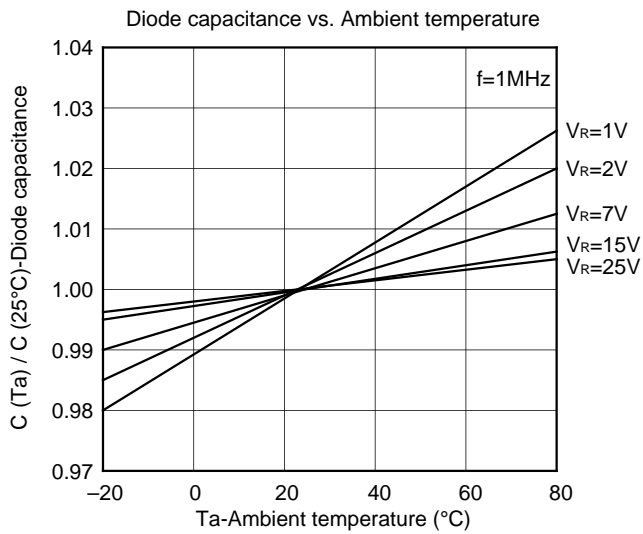
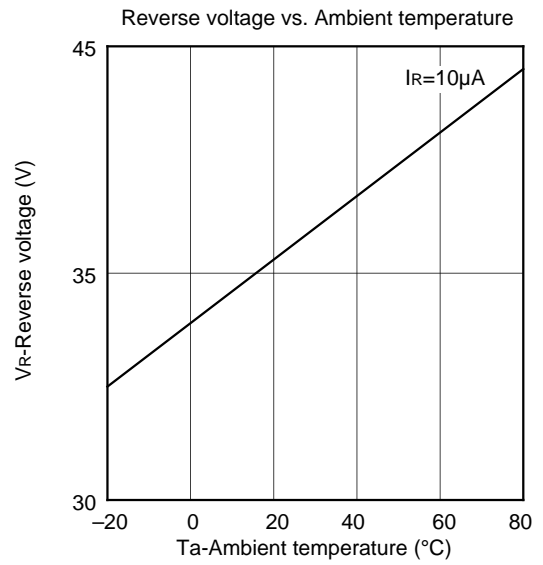
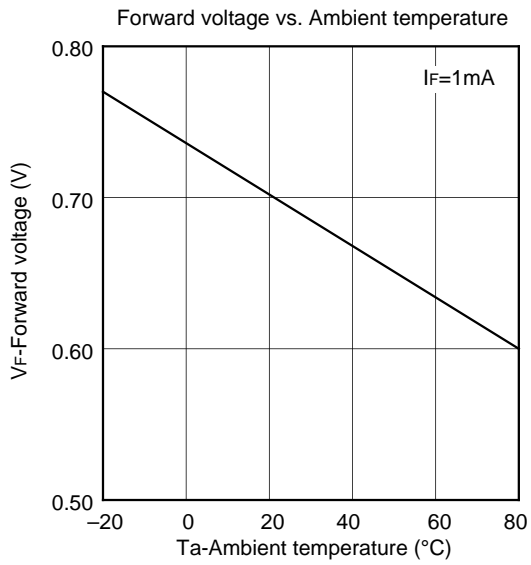

Package Outline Unit : mm

M-290

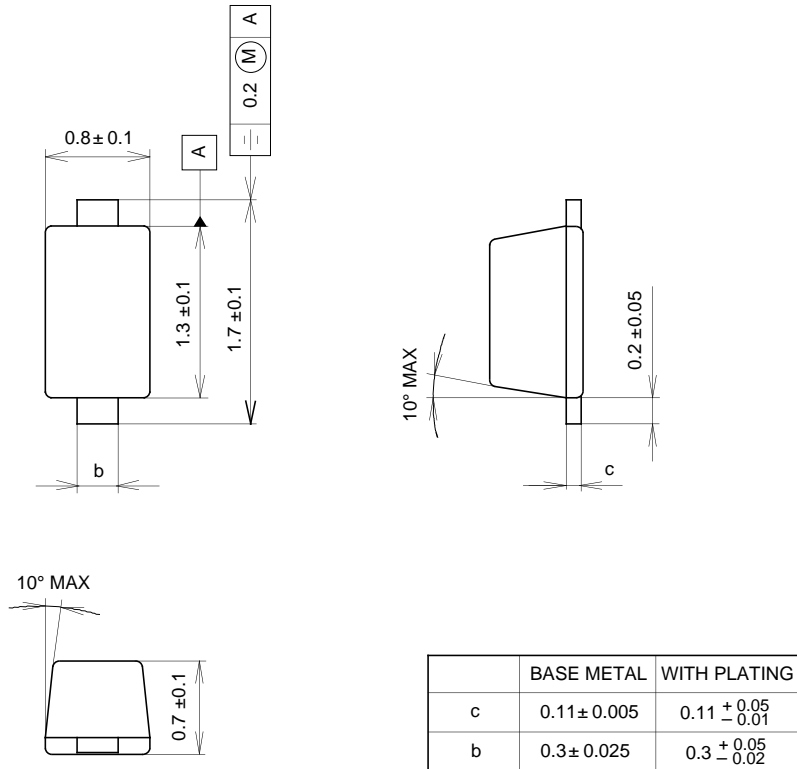

SONY CODE	M-290
EIAJ CODE	_____
JEDEC CODE	_____

PACKAGE MATERIAL	EPOXY RESIN
LEAD TREATMENT	SOLDER PLATING
LEAD MATERIAL	COPPER
PACKAGE WEIGHT	0.002g

MARK

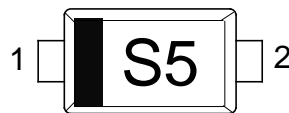

1 : Cathode
2 : Anode