

**NPN Silicon Planar Transistors**

**BDW 25  
BDY 12  
BDY 13**

SIEMENS AKTIENGESELLSCHAFT .433 D

BDW 25, BDY 12, and BDY 13 are epitaxial NPN silicon planar power transistors in SOT 9 case (9 A 2 DIN 41875). The collector is electrically connected to the case. In order to ensure insulated fixing of the transistors on the chassis, a mica washer, each, and two insulating nipples are provided for. These have to be ordered separately. The transistors are particularly suitable for use in high Q AF output stages and as switches.

Type	Ordering code
BDW 25	Q62702-D378
BDW 25-4	Q62702-D378-V4
BDW 25-6	Q62702-D378-V2
BDW 25-10	Q62702-D378-V1
BDY 12	Q60204-Y12
BDY 12-6	Q60204-Y12-B
BDY 12-10	Q60204-Y12-C
BDY 12-16	Q60204-Y12-D
BDY 13	Q60204-Y13
BDY 13-6	Q60204-Y13-B
BDY 13-10	Q60204-Y13-C
BDY 13-16	Q60204-Y13-D
Mica washer	Q62901-B16-A
Insulating nipple	Q62901-B13-C

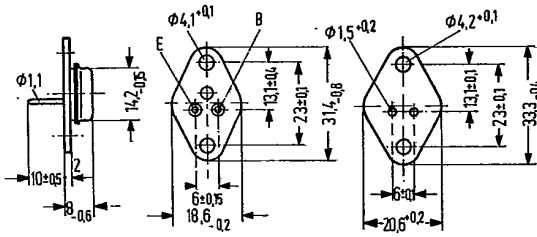

Approx. weight 8.3 g Dimensions in mm  
Mica washer  
dry:  $R_{th} = 2.5 \text{ K/W}$   
greased:  $R_{th} = 1 \text{ K/W}$

**Maximum ratings**

Collector emitter voltage  
Collector-base voltage  
Emitter-base voltage  
Collector current  
Emitter current  
Emitter peak current<sup>1)</sup>  
Base current  
Base peak current<sup>1)</sup>  
Junction temperature  
Storage temperature range  
Total power dissipation  
( $T_{case} = 45 \text{ °C}$ ;  $V_{CE} < 13 \text{ V}$ )

	BDW 25	BDY 12	BDY 13	
$V_{CEO}$	125	40	60	V
$V_{CBO}$	130	60	80	V
$V_{EBO}$	5	5	5	V
$I_C$	5	5	5	A
$I_E$	3.5	-	-	A
$I_{EM}$	6	-	-	A
$I_B$	0.5	0.3	0.3	A
$I_{BM}$	1	-	-	A
$T_j$	175	175	175	°C
$T_{stg}$		-65 to +125		°C
$P_{tot}$	26	26	26	W
$R_{thJA}$	≤ 85	≤ 85	≤ 85	K/W
$R_{thJC}$	≤ 5	≤ 5	≤ 5	K/W

**Thermal resistance**

Junction to ambient air  
Junction to case

1)  $v \geq 10 \text{ t}_p$ ;  $t_p \leq 10 \text{ ns}$

**Static characteristics** ( $T_{case} = 25^{\circ}C$ )

The transistors BDW 25, BDY 12, and BDY 13 are grouped according to the DC current gain  $h_{FE}$  at  $I_C = 1 A$ ,  $V_{CE} = 1 V$ , and marked by numerals of the German DIN-R-5 standard. For the conditions stated below, the following data applies:

Type		BDW 25	BDW 25 BDY 12, BDY 13		BDY 12, BDY 13	BDW 25 BDY 12 BDY 13
$h_{FE}$ group		4	6	10	16	
$V_{CE}$ V	$I_C$ A	$h_{FE}$ $I_C/I_B$	$h_{FE}$ $I_C/I_B$	$h_{FE}$ $I_C/I_B$	$h_{FE}$ $I_C/I_B$	$V_{BE}$ V
1	0.01	35 (> 15)	55	75	120	
1	1	40 (25 to 60)	63 (40 to 100)	100 (63 to 160)	160 (100 to 250)	<1.2*
2	3	25 (> 10)	40	70	120	<1.4

**Static characteristics** ( $T_{case} = 25^{\circ}C$ )

	BDW 25	BDY 12	BDY 13		
Collector-emitter saturation voltage ( $I_C = 3 A$ ; $I_B = 0.3 A$ )	$V_{CEsat}$	<1	<1	<1	V
Base-emitter saturation voltage ( $I_C = 3 A$ ; $I_B = 0.3 A$ )	$V_{BEsat}$	1 (<1.4)	1 (<1.3)	1 (<1.3)	V
Collector cutoff current ( $V_{CE} = 80 V$ )	$I_{CES}$	<1	-	-	$\mu A$
Collector cutoff current ( $V_{CE} = 80 V$ ; $T_{amb} = 125^{\circ}C$ )	$I_{CES}$	<400	-	-	$\mu A$
Collector cutoff current ( $V_{CE} = 40 V$ )	$I_{CES}$	-	<1	-	$\mu A$
Collector cutoff current ( $V_{CE} = 40 V$ ; $T_{amb} = 125^{\circ}C$ )	$I_{CES}$	-	<400	-	$\mu A$
Collector cutoff current ( $V_{CE} = 60 V$ )	$I_{CES}$	-	-	<1	$\mu A$
Collector cutoff current ( $V_{CE} = 60 V$ ; $T_{amb} = 125^{\circ}C$ )	$I_{CES}$	-	-	<400	$\mu A$
Emitter cutoff current ( $V_{EBO} = 4 V$ )	$I_{EBO}$	<1	<1	<1	$\mu A$

\*AQL = 0.65%

**Static characteristics ( $T_{case} = 25^\circ C$ )**

	BDW 25	BDY 12	BDY 13	
Collector emitter breakdown voltage ( $I_C = 50\text{ mA}$ ) (Pulse width 200 $\mu s$ , duty cycle 1%)	$V_{(BR)CEO} > 125$	$> 40$	$> 60$	V
Collector base breakdown voltage ( $I_C = 100\ \mu A$ )	$V_{(BR)CBO} > 130$	$> 60$	$> 80$	V
Emitter base breakdown voltage ( $I_C = 10\ \mu A$ )	$V_{(BR)EBO} > 5$	$> 5$	$> 5$	V

**Dynamic characteristics ( $T_{amb} = 25^\circ C$ )**

Transition frequency ( $I_C = 200\text{ mA}$ ; $V_{CE} = 10\text{ V}$ ; $f = 20\text{ MHz}$ )	$f_T > 30$	70 (>30)	70 (>30)	MHz
Collector base capacitance ( $V_{CB} = 10\text{ V}$ ; $I_E = 0$ ; $f = 1\text{ MHz}$ )	$C_{CBO} < 70$	35 (<70)	35 (<70)	pF
Switching times ( $I_C = 1\text{ A}$ ; $I_{B1}$ approx. $-I_{B2}$ approx. 50mA)	$t_{on} < 0,3$	$< 0,3$	$< 0,3$	$\mu s$
	$t_{off} < 1,5$	$< 1,5$	$< 1,5$	$\mu s$
( $I_C = 2\text{ A}$ ; $I_{B1}$ approx. $-I_{B2}$ approx. 200mA)	$t_{on} < 0,5$	-	-	$\mu s$
	$t_{off} < 2$	-	-	$\mu s$
	$t_s < 1$	-	-	$\mu s$

**Test circuit for switching times**

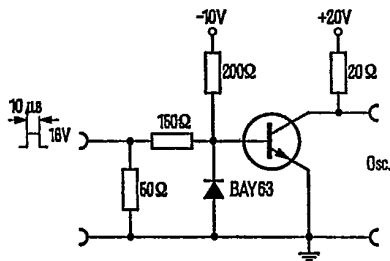

SIEMENS AKTIENGESELLSCHAFT

Total perm. power dissipation versus temperature  
 $P_{tot} = f(T_{case}); V_{CE} = \text{parameter}$

BDY 12

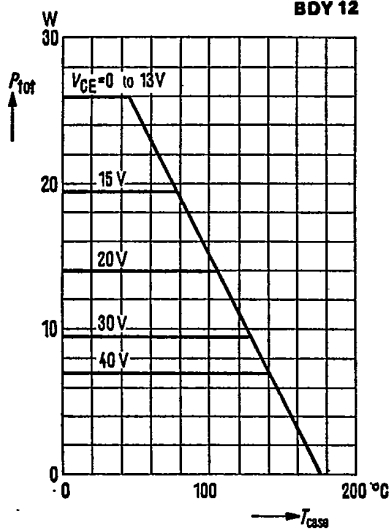

Total perm. power dissipation versus temperature  
 $P_{tot} = f(T_{case}); V_{CE} = \text{parameter}$

BDY 13

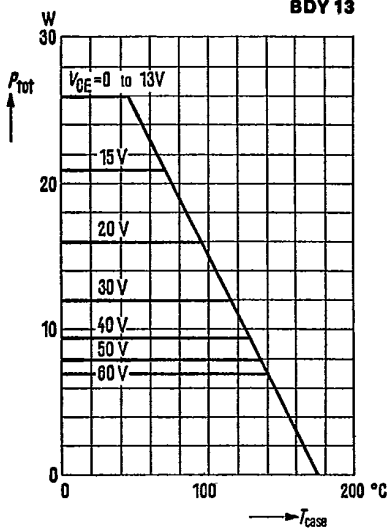

Total perm. power dissipation versus temperature  
 $P_{tot} = f(T_{case}); V_{CE} = \text{parameter}$

BDW 25

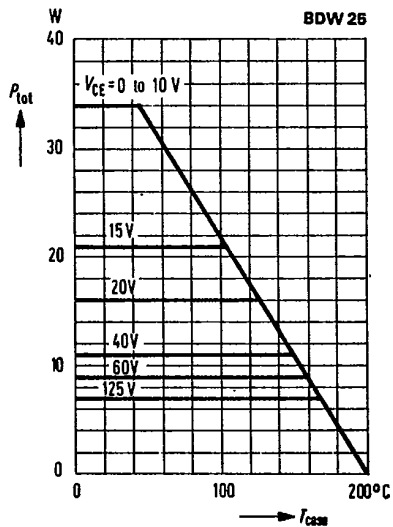

Permissible pulse load  
 $r_{thJC} = f(t); v = \text{parameter}$

BDW 25

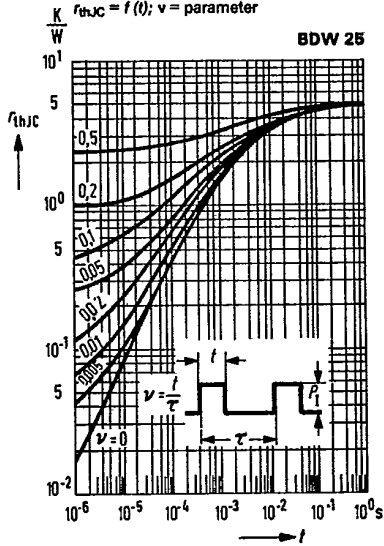

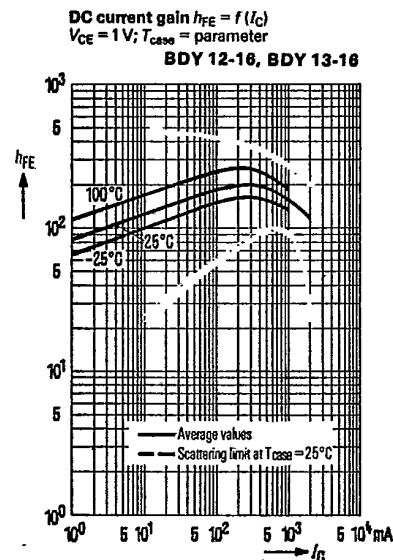
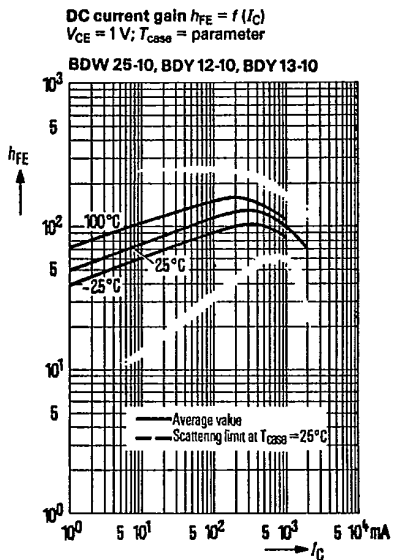
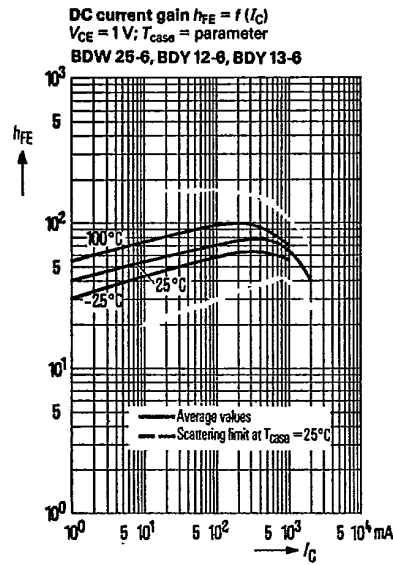
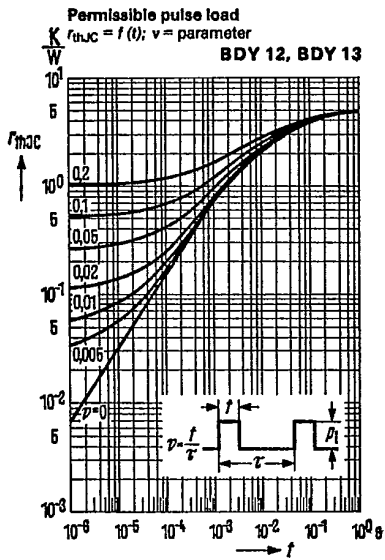

SIEMENS AKTIENGESELLSCHAFT

Output characteristics  $I_C = f(V_{CE})$   
 $I_B = \text{parameter}$   
(common emitter configuration)

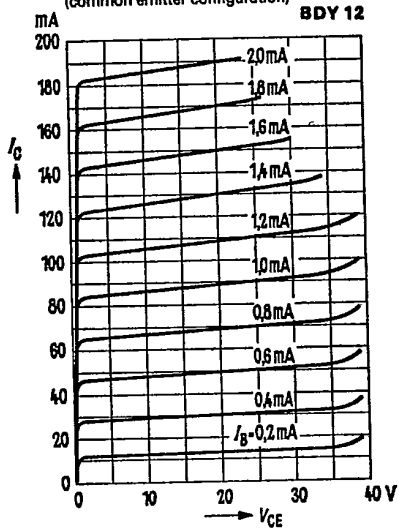

Output characteristics  $I_C = f(V_{CE})$   
 $I_B = \text{parameter}$   
(common emitter configuration)

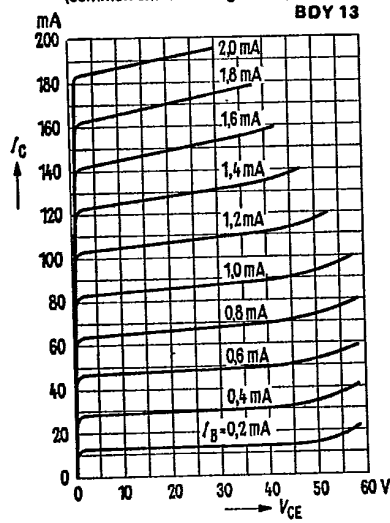

Output characteristics  $I_C = f(V_{CE})$   
 $I_B = \text{parameter}$   
(common emitter configuration)

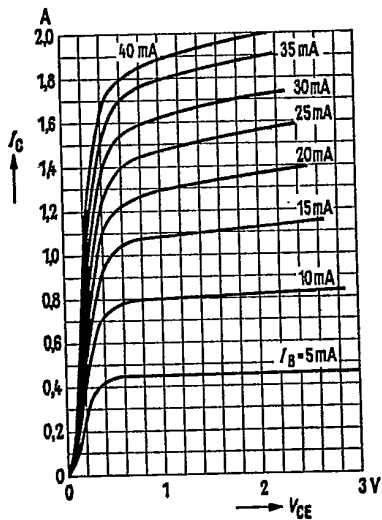

Collector current  $I_C = f(V_{BE})$   
 $V_{CE} = 1V$

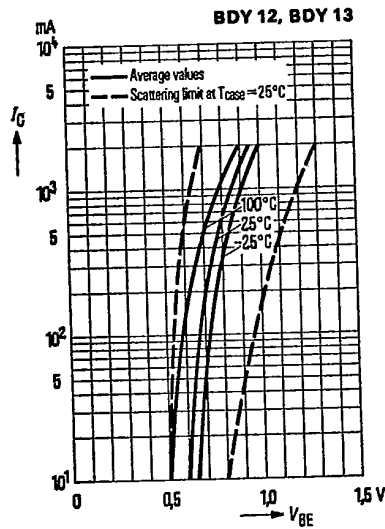

**Collector-emitter saturation voltage**

$V_{CEsat} = f(I_C)$   
 $h_{FE} = 10; T_{case} = \text{parameter}$   
(common emitter configuration)

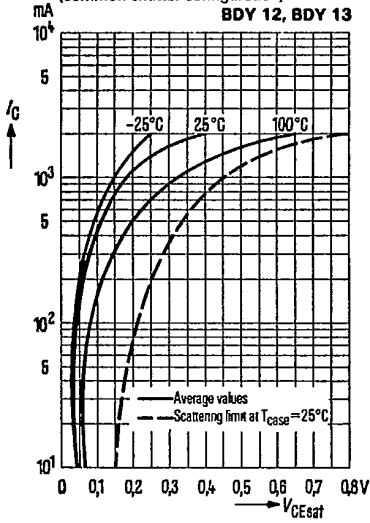

**Base-emitter saturation voltage**

$V_{BEsat} = f(I_C)$   
 $h_{FE} = 10; T_{case} = \text{parameter}$   
(common emitter configuration)

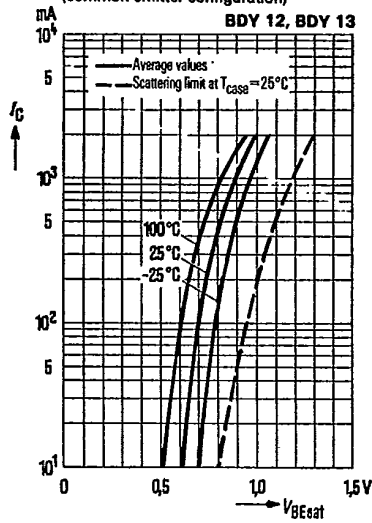

**Collector cutoff current versus temperature**

$I_{CBO} = f(T_{case})$  for maximum permissible reverse voltage

