

SANYO

No.2522

LC7412,7413

CMOS LSI

VTR Servo Digital Controller

General Description

The LC7412,7413 are digital control CMOS LSIs for VTR servo circuit use. Since any servo characteristics can be achieved by coding the on-chip mask ROMs and externally addressing the ROMs, the LC7412,7413 can be applied to any multifunctional VTRs. The LC7412,7413, which contain the functions required for the servo circuit on single chips, can provide a servo system with a good cost performance.

Features

- . Speed/phase control of drum unit (On-chip ROMs)
- . Speed/phase control of capstan unit (On-chip ROMs)
- . Generation of reference signal for phase control (On-chip ROM)
- . Mode select by 4-bit parallel data
- . Recording/playback control of control signal
- . Automatic detection of tape speed during playback mode (SP/LP/EP)
- . Division processing of control signal, capstan FG signal during special playback mode
- . Processing of drum PG signal
- . Pseudo V_D signal generating circuit
- . Generation of switching signal for HIF1 head
- . Generation of 4-head control signal (LC7413)
- . Fine/slow (Frame Advance) timing control (LC7413)
- . Package DIP30S: LC7412
 DIP42S: LC7413

The application circuit diagrams and circuit constants herein are included as an example and provide no guarantee for designing equipment to be mass-produced. The information herein is believed to be accurate and reliable. However, no responsibility is assumed by SANYO for its use, nor for any infringements of patents or other rights of third parties which may result from its use.

Case Outline 3047A-D30SIC
(unit:mm)

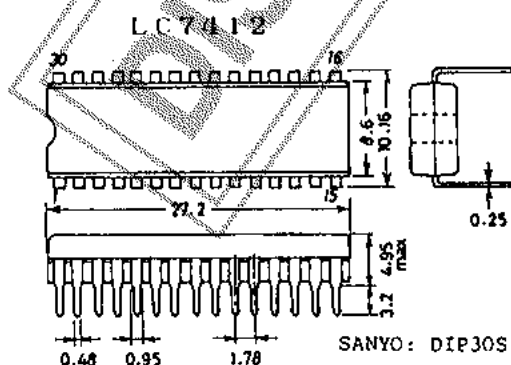

Case Outline 3025B-D42SIC
(unit:mm)

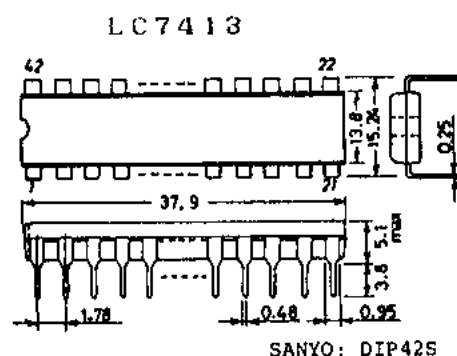

Specifications and information herein are subject to change without notice.

SANYO Electric Co., Ltd. Semiconductor Overseas Marketing Div.
Natsume Bldg., 18-6, 2-chome, Yushima, Bunkyo-ku, TOKYO 113 JAPAN

N197KI, TS No.2522-1/7

LC7412,7413

Equivalent Circuit Block Diagram LC7412

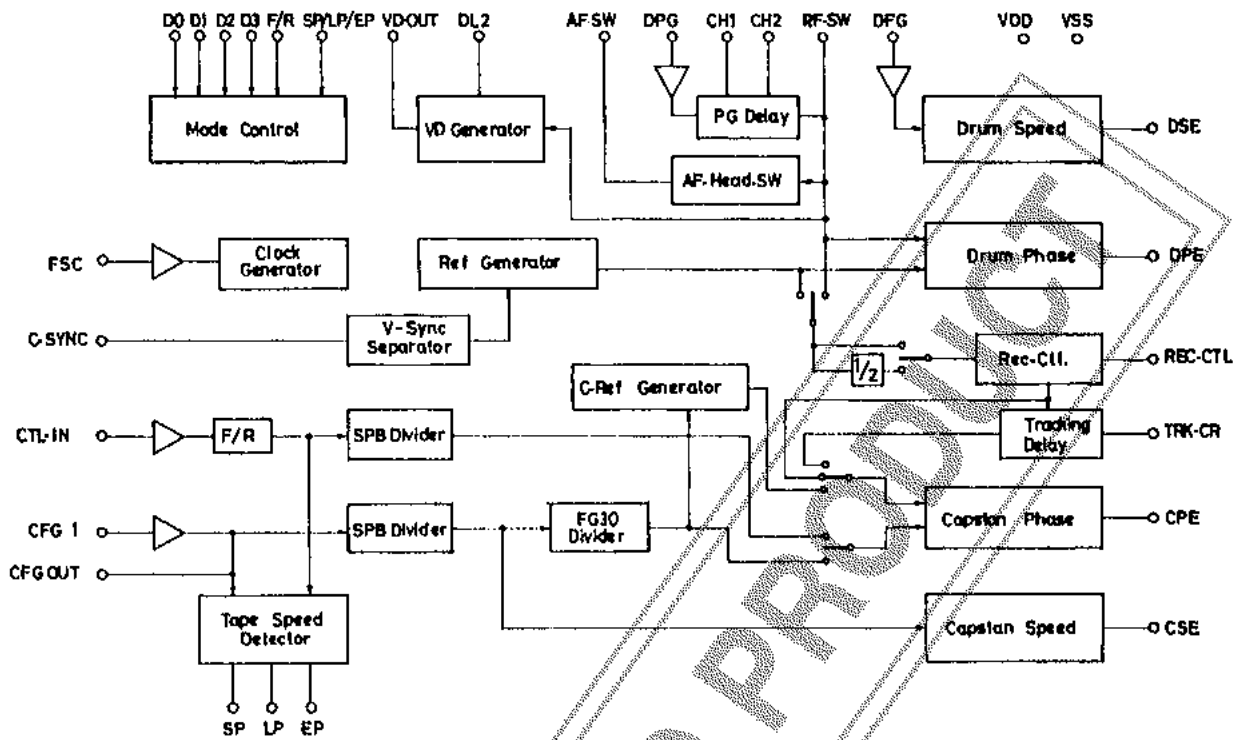

Pin Assignment LC7412

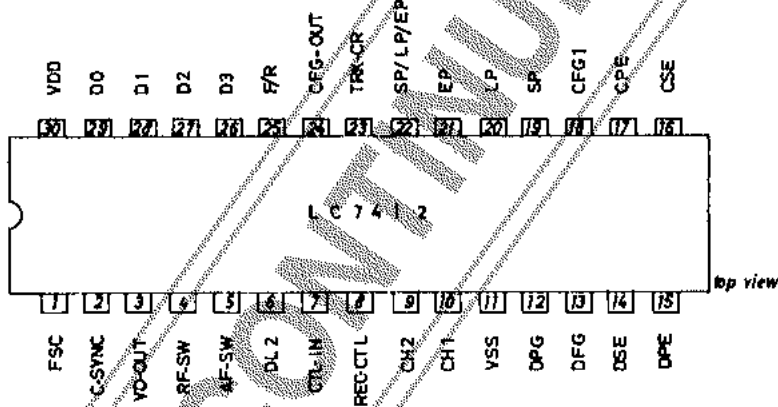

Equivalent Circuit Block Diagram
LC7413

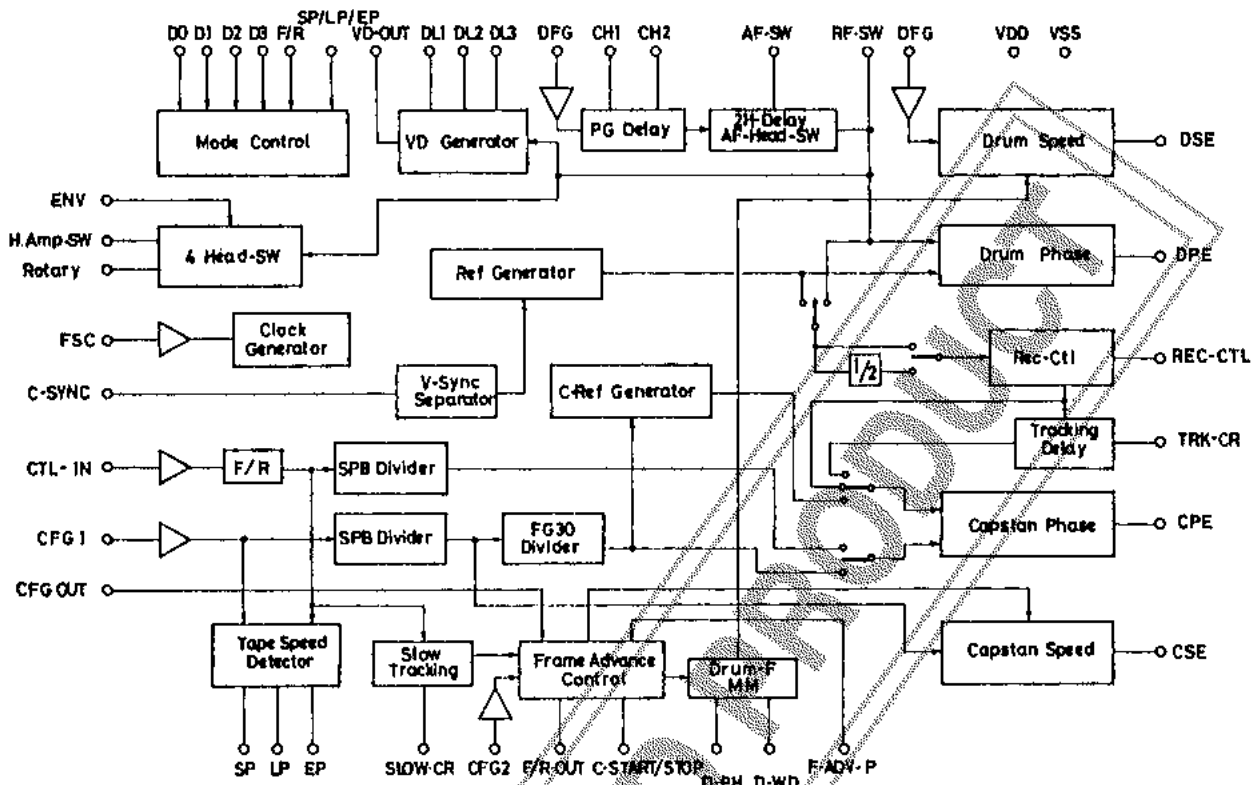

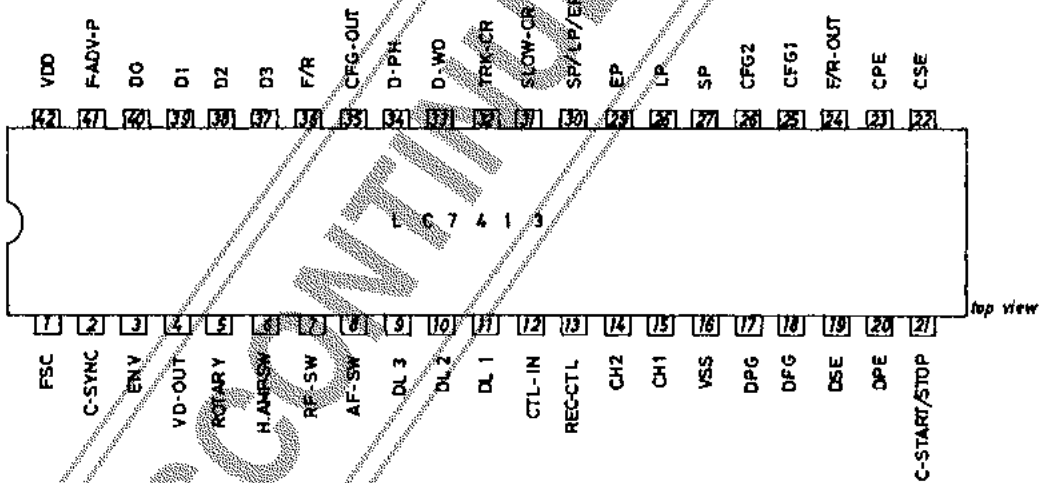

Pin Assignment
LC7413



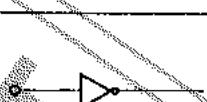

Pin Description

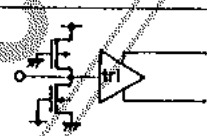
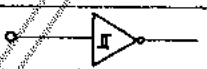
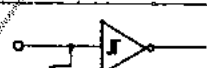
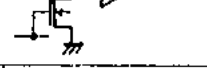
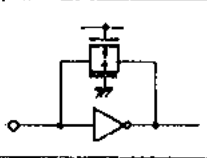
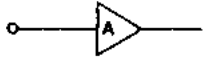
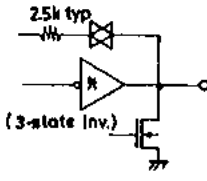
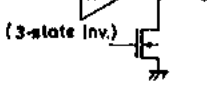
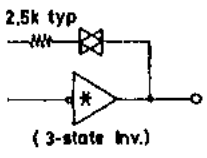
(*:LC7412)

Pin Name	Pin No. (*)	Functions	Input/Output Configuration
VDD	42(30)	LSI power supply VSS:0V	
VSS	16(11)	VDD:4.5 to 5.5V	
D0,D1, D2,D3	40(29),39(28) 38(27),37(26)	Operation mode selection (16 modes) is made by 4-bit binary data. Latch function must be provided externally.	
F/R	36(25)	Forward/reverse selection. "H" level=Forward, "L" level=Reverse	
SP/LP/EP	30(22)	REC tape speed is specified. "H" level=SP, "M" level=LP, "L" level=EP	
C-SYNC	2(2)	Composite sync signal is input.	
F-ADV-P	41(-)	Frame advance pulse is input. Frame advance is made with every pulse.	
ENV	3(-)	Head select signal is input at 4-head special PB mode.	
Fsc	1(1)	Color subcarrier signal to be used for internal system clock of LSI is applied through capacitive coupling. Signal level of 0.3Vp-p or greater is required.	
CTL-IN	12(7)	Control signal is input through capacitive coupling.	
DPG	17(12)	Drum FG signal is input through capacitive coupling.	
DFG	18(13)	Drum FG signal is input through capacitive coupling.	
CFG1	25(18)	FG signal for capstan unit is input. Speed control, phase control, tape speed detection, and the like are performed.	
CFG2	26(-)	Second FG signal for capstan unit is input. Control is performed at frame advance slow mode.	
DSE	19(14)	Low-order 3 bits and high-order 5 to 8 bits of error output of drum unit speed control are output in the form of analog signal and PWM signal, respectively. This pin is brought to "L" level at drum stop mode.	
CSE	22(16)	Low-order 3 bits and high-order 5 to 8 bits of error output of capstan unit speed control are output in the form of analog signal and PWM signal, respectively. This pin is brought to "L" level at capstan stop mode.	
DPE	20(15)	Low-order 3 bits and high-order 5 to 8 bits of error output of drum unit phase control are output in the form of analog signal and PWM signal, respectively. Signal of duty 50% is output at the time of other than mode selection, stop mode, speed slope.	

Continued on next page.

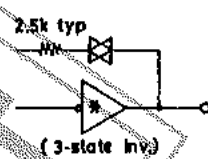
Continued from preceding page.

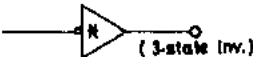
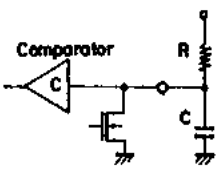
Pin Name	Pin No.(#)	Functions	Input/Output Configuration
CPE	23(17)	Low-order 3 bits and high-order 5 to 8 bits of error output of capstan unit phase control are output in the form of analog signal and PWM signal, respectively. Signal of duty 50% is output at the time of other than mode selection, stop mode, speed slope.	
RF-SW	7(4)	Drum head switching pulse output	
AF-SW	8(5)	Audio FM-use head switching pulse output.	
F/R-OUT	24(-)	Capstan motor forward/reverse control output. Signal is output according to motor start/stop at frame advance mode; and F/R pin input signal is output, as it is, at other than frame advance mode.	
SP	27(19)	REC time mode detect output. SP:"H"	
LP	28(20)	REC time mode detect output. LP:"H"	
EP	29(21)	REC time mode detect output. EP:"H"	
CFG-OUT	35(24)	CFG1 signal output pin. Division signal (1/1, 1/2, 1/4, 1/8) of CFG1 signal is output.	
C-START /STOP	21(-)	Capstan motor start/stop signal is output at frame advance mode.	
ROTARY	5(6)	Head select signal is output at 4-head (3-head) mode.	
H AMP-S	6(-)		
VD-OUT	4(3)	Pseudo vertical sync signal is output at special REC mode. This pin is brought to "L" level at other than special REC mode.	
REC-CTL	13(8)	Control signal is output at REC mode. This pin is brought to high impedance state.	
DL1	9(-)	Pseudo V _D insert position adjust CR pin.	
DL2	10(6)		
DL3	11(-)	DL1 --- Delay amount after RF-SW pulse fall DL2 --- Delay amount after RF-SW pulse rise DL3 --- Position correction at frame advance slow start mode	
CH1	15(10)	DPG detector mounting position adjust CR pin	
CH2	14(9)		
TRK-CR	32(23)	Tracking CR pin	
SLOW-CR	31(-)	Slow tracking CR pin	
D-PH	34(-)	CR pin for drum rotational speed fine timing adjust at frame advance mode	
D-WD	33(-)		

Absolute Maximum Ratings at Ta=25°C				unit
Maximum Supply Voltage	V _{DDmax}		-0.3 to +7.0	V
Maximum Input Voltage	V _{Imax}	Input pins	-0.3 to V _{DD} +0.3	V
Maximum Output Voltage	V _{Omax}	Output pins	-0.3 to V _{DD} +0.3	V
Allowable Power Dissipation	P _{dmax}	Ta=-30 to +70°C	150	mW
Operating Temperature	Topg		-30 to +70	°C
Storage Temperature	Tstg		-55 to +125	°C

Allowable Operating Conditions at Ta=25°C, V _{SS} =0V				min	typ	max	unit
Supply Voltage	V _{DD}		4.5	5.0	5.5	V	
Input "H"-Level Voltage	V _{IH1}	DO, D1, D2, D3	0.7V _{DD}		V _{DD}	V	
	V _{IH2}	SP/LP/EP, F/R, C-SYNC, ENV, F-ADV-P	0.8V _{DD}		V _{DD}	V	
Input "L"-Level Voltage	V _{IL1}	Pins for V _{IH1}	V _{SS}		0.3V _{DD}	V	
	V _{IL2}	Pins for V _{IH2}	V _{SS}		0.2V _{DD}	V	
Input "M"-Level Voltage	V _{IM}	SP/LP/EP	0.4V _{DD}		0.6V _{DD}	V	
Input Amplitude	V _{IN1}	Sine wave capacitive coupling, FSC	0.3			Vp-p	
	V _{IN2}	Capacitive coupling, DFG, CFG1, CFG2, DPG, CTL-IN	1.5			Vp-p	
Input Pulse Width	t _{WI}	DPG, CTL-IN	50			us	
Operating Frequency	f _{IN1}	Sine wave capacitive coupling, FSC	1.0		5.5	MHz	
	f _{IN2}	DFG, CFG1, CFG2	0.1		30	kHz	
	f _{IN3}	DPG, CTL-IN	10		1000	Hz	
	f _{IN4}	t _{WIH} ≥ 1us, C-SYNC	5		50	kHz	
Comparator Characteristics							
Comparison Level	V _{TH}	TRK-CR, DL1, DL2, DL3, CH1, CH2, D-PH, D-WD, SLOW-CR	-10%	0.6V _{DD}	+10%	V	
	V _{TL}	TRK-CR, DL1, DL2, DL3, CH1, CH2, D-PH, D-WD, SLOW-CR	0.1V _{DD}			V	
Delay Time	tdel	R=100kohms, C=0.01uF					
		TRK-CR, DL1, DL2, DL3, CH1, CH2, D-PH, D-WD, SLOW-CR	0.78	0.92	1.08	ms	

Electrical Characteristics at Ta=25°C, V _{DD} =5V±10%, V _{SS} =0V				min	typ	max	unit
Input "H"-Level Current	I _{IH1}	V _{IN} =V _{DD} DO, D1, D2, D3, F/R, C-SYNC			1.0	uA	
	I _{IH2}	V _{IN} =V _{DD} SP/LP/EP, F-ADV-P, ENV	5	10	20	uA	
Input "L"-Level Current	I _{IL1}	V _{IN} =V _{SS} DO, D1, D2, D3, F/R, C-SYNC, ENV, F-ADV-P	-1.0			uA	
	I _{IL2}	V _{IN} =V _{SS} SP/LP/EP	-20	-10	-5	uA	
Input Floating Voltage	V _{IF1}	Input pins open, ENV, F-ADV-P	V _{SS}		V _{IL2}	V	
	V _{IF2}	Input pins open, SP/LP/EP	0.45	0.5	0.55	V	
Output "H"-Level Voltage	V _{OH1}	I _{OL} =0.3mA, SP, LP, EP, CFG-OUT, DSE, DPE, CSE, CPE, V _D -OUT, H AMP-SW, ROTARY, F/R-OUT, RF-SW, AF-SW, C-START/STOP	xV _{DD}	xV _{DD}	xV _{DD}	V	
		I _{OL} =5mA, REC-CTL	V _{DD} -1.0			V	

Continued on next page

Continued from preceding page.

			min	typ	max	unit
Output "L"-Level Voltage	V_{OL1}	$I_{OL}=0.3\text{mA}$, pins for V_{OH1} , TRK-CR, DL1, DL2, DL3, CH1, CH2, D-PH, D-WD, SLOW-CR			0.3	V
	V_{OL2}	$I_{OL}=5\text{mA}$, REC-CTL			1.0	V
	V_{OL3}	$I_{OL}=0.3\text{mA}$, open drain tr. of DSE, CSE			0.6	V
DA Characteristics						
Bit Error	ΔV_{LSB}		-1/2LSB	+1/2LSB		V
Output Impedance	z_o	$R_L=100\text{kohms}$	-30%	3.0	+30%	kohm
R-2R Ladder Composite Resistance	R_{OLDR}			2.5		kohm
DA Output Analog Switch ON-State Resistance	R_{onSW}	$R_L=100\text{kohms}$ ($1\text{LSB}=1/8V_{DD}$)		0.5		kohm
Feedback Resistance	R_f	F_{sc}		0.7		Mohm
Output OFF-State Leakage Current	I_{off1}	DSE, DPE, CSE, CPE	-2.0		2.0	μA
	I_{off2}	REC-CTL	-1.0		1.0	μA
Input Sensitivity	V_{MIN}	Sine wave capacitive coupling, DFG, CFG1, CFG2, DPG, CTL-IN	0.5	1.0	1.5	Vp-p
Current Dissipation	I_{DD}	$f_{sc}=4.43\text{MHz}$ (0.3Vp-p) input			10.0	mA

Sample Application Circuit: LA7116 + LC7412

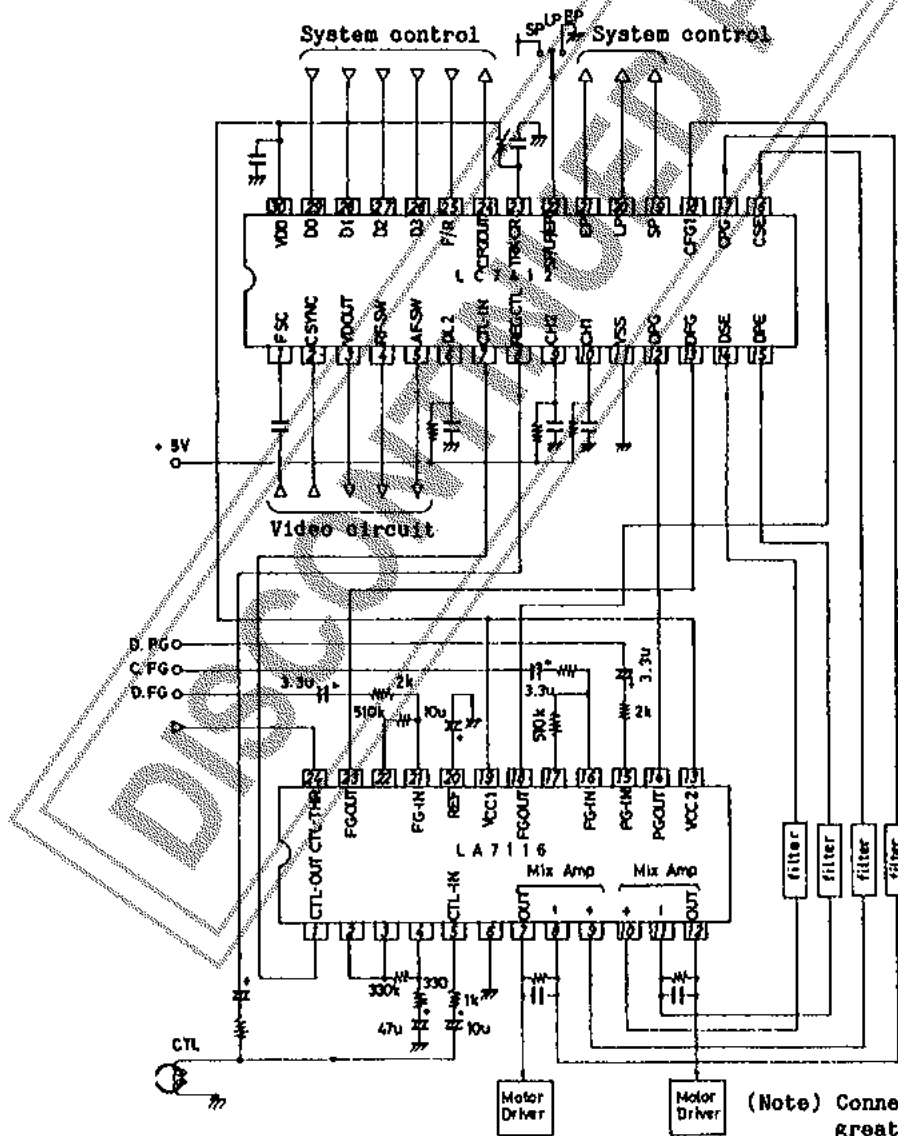

(Note) Connect a capacitor of 0.1 μF or greater to the power line to prevent latch-up.