

### FEATURES

- 40 MHz operation
- Easy Interface to Motorola and Intel CPUs
- 68040/68030 burst mode operation
- i486 burst mode operation
- Page, static column and nibble mode accesses
- Interleaved and non-interleaved accesses
- Synchronous and asynchronous operation
- Direct drive for 256K, 1Mbit, 4Mbit, and 16Mbit DRAMs
- High capacitive load, slew rate controlled drivers
- Page switch detection logic
- Built in precision delay line
- Four independent RAS and CAS outputs
- Programmable wait state generation logic
- Single or burst refresh
- Error scrubbing during refresh
- CMOS technology for low power consumption
- TTL compatible inputs
- 68-pin PLCC package (KS84C31)
- 84-pin PLCC package (KS84C32)

### PRODUCT OVERVIEW

The Samsung KS84C31 and KS84C32 are high performance dynamic RAM (DRAM) controllers. They simplify the interface between the microprocessor and the DRAM array, while also significantly reducing the required design time. The KS84C31 supports 256K, 1 Mbit, and 4 Mbit DRAMs, while the KS84C32 supports 256K, 1 Mbit, 4 Mbit, and 16 Mbit DRAMs.

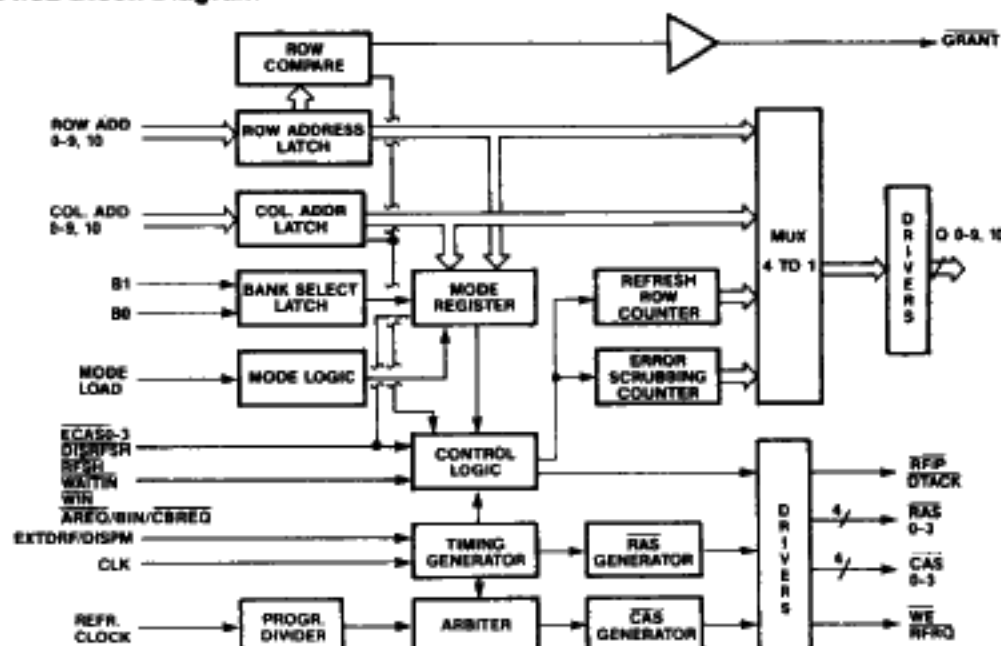
Both devices are functionally enhanced versions of their KS84C21/22 counterparts. These user programmable devices are an economical and flexible design solution. The 26-bit programmable Mode Register allows the selection of various options and features.

The MC68030™, MC68040™ and i486™ microprocessors are supported by special programming modes specifically tailored to their bus operations.

Both chips have a drive capability of 380 pf, sufficient to drive large memory arrays. Several hundred DRAMs may be driven if damping resistors are used to control ground bounce.

Figure 1 shows a block diagram of the chips.

Figure 1. KS84C31/32 Block Diagram



™ MC68030, MC68040 are registered trademarks of Motorola, Inc.

™ i486 is a registered trademark of Intel, Inc.

# KS84C31/32

## INTRODUCTION

The KS84C31/32 are Dynamic Ram Controllers (hereafter referred to as DRCs) which are built upon the proven KS84C21/22 architecture with enhancements that improve memory access time and make it especially suitable for cache based memory systems. The DRC contains all of the advanced features of its predecessor including the capabilities of address latches, refresh counter, refresh clock, address multiplexor, precision delay line, refresh/access arbitration logic, high capacitive output drivers and on-chip damping resistors. A programmable system interface allows any manufacturer's CPU or cache controller to be interfaced to DRAM arrays up to 64 Mbytes in size.

The incorporation of on-chip page detection logic enables the DRC to support random accesses within a page for use with page and static column mode DRAMs. A 2-bit wrap around column counter may be used during burst accesses. On-chip RAS timeout circuitry enables the DRC to maintain an active RAS signal while EPROM or I/O is referenced, greatly improving system performance in embedded control applications and during data transfers between memory and I/O.

The MC68030, MC68040 and i486 burst cache fill accesses are supported. The special 68030 programming mode supports a burst memory access which doubles the 68030's cache hit ratio when compared against memory controllers that inhibit bursting.

The DRC must be programmed after power up before the DRAM array is referenced. The DRC is programmed through the address bus.

There are two methods of programming the chip. The first method, Mode Load, is performed by first asserting the mode load ( $\overline{ML}$ ) signal and presenting the programming selection on the row, column, bank and  $\overline{ECAS}$  inputs. The programming selection is loaded into the Mode Register when  $\overline{ML}$  is negated.

The second method, Fake Access, is performed by first asserting  $\overline{ML}$ , then performing a chip selected access. The programming value present on the address bus when  $\overline{AREQ}$  is asserted is loaded into the Mode Register. The DRC then asserts the appropriate control signals to terminate the chip selected access.

The DRC supports two access modes, synchronous (Access Mode 0) and asynchronous (Access Mode 1). To access the DRAM in Mode 0, the address latch enable (ALE) signal is asserted.  $\overline{RAS}$  will be asserted on the next rising clock edge. To access the DRAM in Mode 1, the address strobe ( $\overline{ADS}$ ) signal is asserted causing  $\overline{RAS}$  to be asserted immediately.

The KS84C31/32 DRC offers four refreshing control modes:

- 1) internal automatic refreshing
- 2) internal automatic burst refreshing
- 3) externally controlled/burst refreshing
- 4) refresh request/acknowledge refreshing

When using internal automatic refreshing, the DRC's refresh request clock generates internal refresh requests. The DRC arbitrates between refresh requests and accesses. If an access is not currently in progress, the DRC will assert the refresh in progress signal ( $\overline{RFIP}$ ). The refresh will start on the next rising clock edge. If an access had been in progress, the refresh would be delayed until the access is terminated.

Internal automatic burst refreshing is available when Page Mode is programmed. After the refresh request clock has generated the fifth internal refresh request, the DRC will arbitrate between the refresh request and any accesses in progress. The DRC will assert  $\overline{RFIP}$  and perform a five refresh burst.

To use externally controlled burst/refreshing, the internally requested refreshes are disabled by asserting the disable refresh ( $\overline{DISFRSH}$ ) signal. A refresh can now be requested externally by asserting the refresh ( $\overline{RFSH}$ ) signal. The DRC will arbitrate between accesses and external refresh requests, assert  $\overline{RFIP}$  and perform the refresh.

When refresh request/acknowledge refreshing is used, the DRC broadcasts the internal refresh request by asserting the refresh request ( $\overline{RFRQ}$ ) signal. External circuitry can determine when to enable the refresh by asserting  $\overline{RFSH}$ . When  $\overline{RFSH}$  is asserted, the DRC will perform an externally controlled/burst refresh.

The DRC supports two types of refreshing

- 1)  $\overline{RAS}$  Only
- 2)  $\overline{RAS}$  Only with Error Scrubbing

In a  $\overline{RAS}$  only refresh, all the  $\overline{RAS}$  outputs will be asserted and negated at once. Error scrubbing is the same as RAS only refresh except that a  $\overline{CAS}$  and column address will be asserted during refresh, allowing the system to run the data through an error detection/correction chip and write it back to memory if an error has occurred.

# KS84C31/32

The DRC provides wait state support through its DTACK and GRANT output signals. Both signals may be used during Modes 0 and 1. DTACK is asserted by the on-chip wait state logic after a pre-programmed number of clock

cycles to terminate the access. GRANT is asserted by the DRC to inform external circuitry that the DRC has begun an access. DTACK can be dynamically delayed by asserting the WAITIN input.

Figure 2a. Pin Configuration of the KS84C31 DRAM Controller

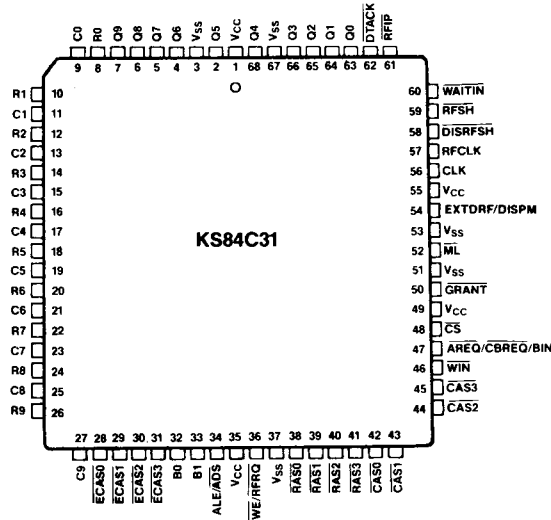
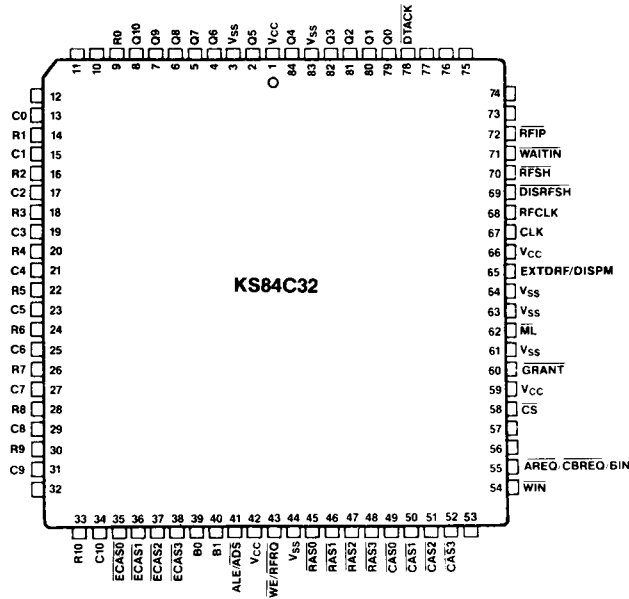


Figure 2b. Pin Configuration of the KS84C32 DRAM Controller



# KS84C31/32

When a page miss is detected, the DRC will insert wait states during the access and precharge the memory.

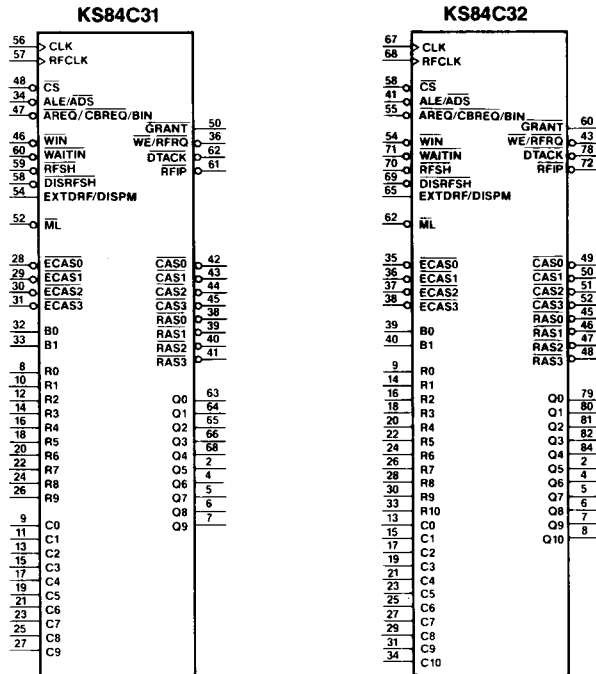
The DRC has address latches, used to latch the row, column, and bank address inputs. The latches may also be used in fall through mode, even when the DRC is programmed for page mode operation. (The page address is latched in a separate page register).

The  $\overline{\text{RAS}}$  and  $\overline{\text{CAS}}$  drivers can be configured to drive a 1, 2, 3 or 4 bank memory array up to 36 bits in width (32 data, 4 parity). The  $\overline{\text{CAS}}$  enable (ECAS) signals can then be used to selectively enable the  $\overline{\text{CAS}}$  drivers for byte writing without requiring external logic. The DRC contains internal logic that ensures that the  $\overline{\text{CAS}}$  outputs will not be asserted in case of a page miss, thus preventing spurious data writes to an incorrect page.

When configuring the DRC for more than one bank, memory interleaving can be used. The DRC can perform 2 or 4 way interleaving to eliminate wait states due to  $\overline{\text{RAS}}$  precharge time.

The Dynamic Ram Controller is available in two packages. The KS84C31, shown in Figure 2a, is available in a 68 pin PLCC and supports 256K, 1 Mbit, and 4 Mbit DRAMs. The KS84C32, shown in Figure 2b, is available in an 84 pin PLCC and supports 256K, 1 Mbit, 4 Mbit, and 16 Mbit DRAMs. The logic symbols are shown in Figure 3.

Figure 3. Logic Symbol



# KS84C31/32

Tables 1 and 2 show detailed pin allocations for the KS84C31 and KS84C32, respectively.

**Table 1. KS84C31 Pin Allocations**

Pin No.	Signal Abbrev.	Signal Name
1	V <sub>CC</sub>	V <sub>CC</sub>
2	Q5	Multiplexed Address 5
3	V <sub>SS</sub>	V <sub>SS</sub>
4	Q6	Multiplexed Address 6
5	Q7	Multiplexed Address 7
6	Q8	Multiplexed Address 8
7	Q9	Multiplexed Address 9
8	R0	Row Address 0
9	C0	Column Address 0
10	R1	Row Address 1
11	C1	Column Address 1
12	R2	Row Address 2
13	C2	Column Address 2
14	R3	Row Address 3
15	C3	Column Address 3
16	R4	Row Address 4
17	C4	Column Address 4
18	R5	Row Address 5
19	C5	Column Address 5
20	R6	Row Address 6
21	C6	Column Address 6
22	R7	Row Address 7
23	C7	Column Address 7
24	R8	Row Address 8
25	C8	Column Address 8
26	R9	Row Address 9
27	C9	Column Address 9
28	$\overline{\text{ECAS0}}$	Enable CAS0
29	$\overline{\text{ECAS1}}$	Enable CAS1
30	$\overline{\text{ECAS2}}$	Enable CAS2
31	$\overline{\text{ECAS3}}$	Enable CAS3
32	B0	Bank Select 0
33	B1	Bank Select 1
34	ALE/ADS	Address Latch Enable/ Address Strobe

Pin No.	Signal Abbrev.	Signal Name
35	V <sub>CC</sub>	V <sub>CC</sub>
36	RFRQ/WE	Refresh Request/Write Enable
37	V <sub>SS</sub>	V <sub>SS</sub>
38	RAS0	Row Address Strobe 0
39	RAS1	Row Address Strobe 1
40	RAS2	Row Address Strobe 2
41	RAS3	Row Address Strobe 3
42	CAS0	Column Address Strobe 0
43	CAS1	Column Address Strobe 1
44	CAS2	Column Address Strobe 2
45	CAS3	Column Address Strobe 3
46	WIN	Write Enable Input
47	AREQ	Access Request
	CBREQ	Cache Burst Request
	BIN	Burst Inhibit
48	CS	Chip Select
49	V <sub>CC</sub>	V <sub>CC</sub>
50	GRANT	Access Grant
51	V <sub>SS</sub>	V <sub>SS</sub>
52	ML	Mode Load
53	V <sub>SS</sub>	V <sub>SS</sub>
54	EXTDRF	Extend Refresh
	DISPM	Disable Page Mode
55	V <sub>CC</sub>	V <sub>CC</sub>
56	CLK	Clock
57	RFCLK	Refresh Clock
58	DISRFSH	Disable Internal Refresh
59	RFSH	External Refresh Request
60	WAITIN	Add Wait State
61	RFIP	Refresh in Progress
62	DTACK	Data Transfer Acknowledge
63	Q0	Multiplexed Address 0
64	Q1	Multiplexed Address 1
65	Q2	Multiplexed Address 2
66	Q3	Multiplexed Address 3
67	V <sub>SS</sub>	V <sub>SS</sub>
68	Q4	Multiplexed Address 4

**Table 2. KS84C32 Pin Allocations**

Pin No.	Signal Abbrev.	Signal Name
1	V <sub>CC</sub>	V <sub>CC</sub>
2	Q5	Multiplexed Address 5
3	V <sub>SS</sub>	V <sub>SS</sub>
4	Q6	Multiplexed Address 6
5	Q7	Multiplexed Address 7
6	Q8	Multiplexed Address 8
7	Q9	Multiplexed Address 9
8	Q10	Multiplexed Address 10
9	R0	Row Address 0
10	—	N.C.
11	—	N.C.
12	—	N.C.
13	C0	Column Address 0
14	R1	Row Address 1
15	C1	Column Address 1
16	R2	Row Address 2
17	C2	Column Address 2
18	R3	Row Address 3
19	C3	Column Address 3
20	R4	Row Address 4
21	C4	Column Address 4
22	R5	Row Address 5
23	C5	Column Address 5
24	R6	Row Address 6
25	C6	Column Address 6
26	R7	Row Address 7
27	C7	Column Address 7
28	R8	Row Address 8
29	C8	Column Address 8
30	R9	Row Address 9
31	C9	Column Address 9
32	—	N.C.
33	R10	Row Address 10
34	C10	Column Address 10
35	ECAS0	Enable CAS0
36	ECAS1	Enable CAS1
37	ECAS2	Enable CAS2
38	ECAS3	Enable CAS3
39	B0	Bank Select 0
40	B1	Bank Select 1
41	ALE/ADS	Address Latch Enable/ Address Strobe
42	V <sub>CC</sub>	V <sub>CC</sub>

Pin No.	Signal Abbrev.	Signal Name
43	RRFQ/WE	Refresh Request/Write Enable
44	V <sub>SS</sub>	V <sub>SS</sub>
45	RAS0	Row Address Strobe 0
46	RAS1	Row Address Strobe 1
47	RAS2	Row Address Strobe 2
48	RAS3	Row Address Strobe 3
49	CAS0	Column Address Strobe 0
50	CAS1	Column Address Strobe 1
51	CAS2	Column Address Strobe 2
52	CAS3	Column Address Strobe 3
53	—	N.C.
54	WIN	Write Enable Input
55	AREQ	Access Request
	CBREQ	Cache Burst Request
	BIN	Burst Inhibit
56	—	N.C.
57	—	N.C.
58	CS	Chip Select
59	V <sub>CC</sub>	V <sub>CC</sub>
60	GRANT	Access Grant
61	V <sub>SS</sub>	V <sub>SS</sub>
62	ML	Mode Load
63	V <sub>SS</sub>	V <sub>SS</sub>
64	V <sub>SS</sub>	V <sub>SS</sub>
	EXTDRF	Extend Refresh
65	DISPM	Disable Page Mode
	V <sub>CC</sub>	V <sub>CC</sub>
66	V <sub>CC</sub>	V <sub>CC</sub>
67	CLK	Clock
68	RFCLK	Refresh Clock
69	DISRFSH	Disable Internal Refresh
70	RFSH	External Refresh Request
71	WAITIN	Add Wait State
72	RFIP	Refresh in Progress
73	—	N.C.
74	—	N.C.
75	—	N.C.
76	—	N.C.
77	—	N.C.
78	DTACK	Data Transfer Acknowledge
79	Q0	Multiplexed Address 0
80	Q1	Multiplexed Address 1
81	Q2	Multiplexed Address 2
82	Q3	Multiplexed Address 3
83	V <sub>SS</sub>	V <sub>SS</sub>
84	Q4	Multiplexed Address 4

Table 3. Interface Signal Descriptions

Symbol	Type	Descriptions
<b>Access Signals</b>		
ADS (ALE)	I	<p><b>Address Strobe (Address Latch Enable):</b> This input latches row, column and bank addresses, and initiates the DRAM access.</p> <p>ADS (ALE) must be invoked for every non-burst access. ADS (ALE) need only be invoked for the opening cycle of a burst access when used with microprocessors that only assert ADS (ALE) during the opening cycle.</p> <p>In Access Mode 0, this input functions as Address Latch Enable (ALE). In Access Mode 1, this input functions as Address Strobe (ADS).</p>
CS	I	<p><b>Chip Select:</b> The CS input must be active to enable a DRAM access. CS must enable every non-burst access. CS need only be invoked for the opening cycle of a burst access when used with microprocessors that only assert ADS (ALE) during the opening access.</p>
AREQ (CBREQ) (BIN)	I	<p><b>Access Request (Cache Burst Request) (Burst Inhibit):</b> This input terminates an access.</p> <p>AREQ: In Single Access Mode, this input functions as Access Request. It brings RAS and CAS high to terminate the access. In Page Access Mode, AREQ only brings CAS high.</p> <p>CBREQ: In 68030 Burst Mode, this signal functions as Cache Burst Request. CBREQ is sampled on the rising edge of CLK that negates DTACK. Directly compatible with the MC68030's CBREQ signal, it controls the termination of the DRC's burst access. It brings RAS and CAS high to terminate the burst. When combined with Page Mode, only CAS is brought high.</p> <p>BIN: When programmed for 68040 Burst Mode, this signal functions as Burst Inhibit. Burst Inhibit is sampled on the rising edge of CLK that negates DTACK. BIN prevents the DRC from bursting if the CPU aborts the burst or is performing a single access. It brings RAS and CAS high to terminate the burst. When combined with Page Mode only CAS is brought high.</p>
DTACK	O	<p><b>Data Transfer Acknowledge:</b> This output is asserted to terminate the CPU access. In Single Access Mode and Page Mode, it is negated when the access is terminated by AREQ. In both burst modes, DTACK is negated on the first rising clock edge after it has been asserted.</p>
WAITIN	I	<p><b>Wait State Insert:</b> This input is used to dynamically add wait states during a bus cycle. If R6=0 during programming, WAITIN is used to add one wait state during the access. WAITIN is sampled once during the access, when DTACK is to be asserted by the DRC. DTACK will remain negated for one more rising CLK edge if DTACK is rising edge triggered or one more falling CLK edge if DTACK is falling edge triggered. WAITIN will not be sampled again, until the next access.</p> <p>If R6=1 during programming, WAITIN may be used to defer DTACK indefinitely. WAITIN is sampled at the access start. If WAITIN is inactive, the DRC will assert DTACK after the programmed number of CLK edges. If WAITIN was active, the DTACK CLK edge count is deferred. WAITIN will be continually sampled on the rising edge of CLK if DTACK is rising edge triggered or on the falling edge of CLK if DTACK is falling edge triggered. Once WAITIN is negated, the DRC will assert DTACK after the programmed number of CLK edges and will not sample WAITIN again until the next access.</p>

**Table 3. Interface Signal Descriptions (Continued)**

Symbol	Type	Descriptions
<b>Access Signals (Continued)</b>		
GRANT	O	<b>Access Grant:</b> This output is asserted only when RAS is asserted for a DRAM access. It is asserted at the beginning of an access to indicate that the access has begun. If an access is deferred due to a refresh cycle, page miss, or to satisfy RAS precharge time, GRANT will not be asserted until the access has begun. GRANT will remain asserted until the access RAS is negated.
<b>Address, R/W and Programming Signals</b>		
C0-9,10	I	<b>Column Address Inputs:</b> These address bits are connected to the CPU's address bus. When the DRC is programmed for use with page mode or static column DRAMs, they should be connected to the low order address bits.
R0-9,10	I	<b>Row Address Inputs:</b> These address bits are connected to the CPU's address bus. When the DRC is programmed for use with page or static column mode DRAMs, they should be connected to the higher order address bits.
B0, B1	I	<b>Bank Select:</b> These inputs select the memory bank to be addressed. Up to four banks are supported by the DRC.
ECAS0-3	I	<b>Enable CAS0-3:</b> These inputs are used to enable or disable individual CAS outputs when accessing bytes, words or doublewords. They can also be used to delay the falling edge of CAS.
WIN	I	<b>Write Enable Input:</b> This input controls the Write Enable (WE) output. If programmed to do so, it also delays the falling edge of CAS by one rising CLK edge during page hits and one CLK period during burst accesses. It does not delay the falling edge of CAS in Single Access Mode or the opening cycle of a burst access that results in a page miss. When the leading edge of CAS is delayed by WIN, one wait state is automatically added to the access cycle.  WIN is sampled when a burst or page hit access starts in all operating modes and also on the rising edge of CLK that negates DTACK when the DRC is bursting.
ML	I	<b>Mode Load:</b> This input strobes the row, column, bank and ECAS0-3 inputs into the Mode Register.
<b>DRAM Control Signals</b>		
Q0-9,10	O	<b>Address Outputs:</b> These outputs are the multiplexed address bits (R0-10, C0-10). They access the memory for read, write and refresh operations. The output loading is rated at 380 pF.
RAS0-3	O	<b>Row Address Strobe:</b> These output signals are used to strobe the row address into the DRAM.
CAS0-3	O	<b>Column Address Strobe:</b> These output signals are used to strobe the column address into the DRAM.
WE (RFRQ)	O	<b>Write Enable (Refresh Request):</b> After power up and when the DRC is programmed for interleaved operation, this output functions as Refresh Request. When the DRC is not programmed for interleaved operation, this output may be programmed as Write Enable or Refresh Request.  When programmed as WE, this output is controlled by the WIN input. The output loading is rated at 500 pF. When programmed as RFRQ, the DRC asserts this output whenever a refresh request has been generated by the internal refresh interval timer. RFRQ is negated when the refresh begins.



Table 3. Interface Signal Descriptions (Continued)

Symbol	Type	Descriptions
<b>Refresh Control Signals</b>		
EXTDRF (DISPM)	I	<p><b>Extend Refresh (Disable Page Mode):</b> When the DRC is programmed to support error scrubbing, this pin is time multiplexed.</p> <p>During refresh, this input extends the refresh cycle to allow a read-modify-write cycle to be performed in a system with error scrubbing. During accesses, this pin is used to terminate RAS when the DRC is programmed for Page Mode.</p> <p>When the DRC is not programmed to support error scrubbing, this pin only functions as Disable Page Mode and does not affect refresh cycles.</p>
DISRFSH	I	<p><b>Disable Internal Refresh:</b> This input prevents the DRC from performing internally requested refreshes. This signal could be asserted to prevent the DRC from performing refreshes during DMA transfers, while the CPU is executing time critical code or if refreshes are going to be controlled externally.</p>
RFIP	O	<p><b>Refresh In Progress:</b> This output indicates that a refresh cycle is in progress. RFIP is asserted one clock cycle prior to the start of a refresh cycle.</p>
RFSH	I	<p><b>External Refresh:</b> Refresh requests can be generated externally by asserting this input when DISRFSH is low.</p>
<b>Clock Inputs</b>		
CLK	I	<p><b>System Clock:</b> This input should be connected to the system bus clock. It is used for access arbitration and timing.</p>
RFCLK	I	<p><b>Refresh Clock:</b> This input determines the interval between internally requested refreshes. RFCLK must be synchronous to CLK, but need not be the same frequency as CLK. It is divided internally, according to the value in the Mode Register, so that refresh requests are generated at 15 <math>\mu</math>s or 13 <math>\mu</math>s intervals.</p>

## ACCESS START AND TERMINATION MODES

The KS84C31/32 supports both synchronous and asynchronous access modes. The user selects the mode best suited to the microprocessor by programming bit B1 of the Mode Register.

### Mode 0 — Synchronous Access Start and Termination

Mode 0 is selected when B1 = 0 during programming. To initiate a Mode 0 access, ALE is pulsed high and a valid  $\overline{CS}$  signal is asserted before the input clock's (CLK) rising edge. The access will start on the rising edge of CLK as shown in Figure 4, provided that the ALE and  $\overline{CS}$  setup times were observed, the RAS precharge time was met and a refresh was not currently in progress. If the RAS precharge time was not met from the previous access or a refresh was in progress, the DRC will wait until these events have taken place before asserting RAS on the rising edge of CLK.

The DRC will begin sampling  $\overline{AREQ}$  on the rising edge of CLK after DTACK is asserted. The access will continue until  $\overline{AREQ}$  is negated.

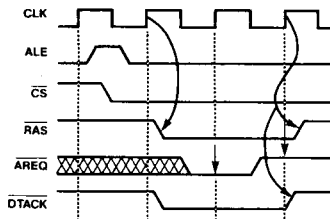
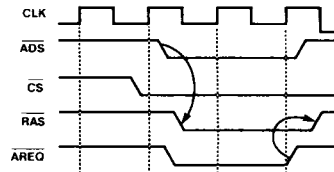


Figure 4. Synchronous Access Start and Termination

### Mode 1 — Asynchronous Access Start and Termination

Mode 1 is selected when B1 = 1 during programming. To initiate a Mode 1 access,  $\overline{CS}$  is asserted, followed by  $\overline{ADS}$ . The access will start when  $\overline{ADS}$  is asserted as shown in Figure 5, provided that the RAS precharge time was met and a refresh was not currently in progress. If the RAS precharge time was not met from the previous access or a refresh was in progress, the DRC will wait until these events have taken place before asserting RAS on the rising edge of CLK. The access will be terminated when  $\overline{AREQ}$  is negated.

Figure 5. Asynchronous Access Start and Termination



## OPERATING MODES

The KS84C31/32 may be programmed to operate in several different modes, depending on the CPU characteristics and type of DRAM used. The Single Access Mode is recommended for use in slower speed systems in which there is no advantage to be gained from a  $\overline{CAS}$  only access and where the RAS precharge time is hidden between back to back accesses. For higher performance systems, Page Mode operation is provided and may be used with page or static column DRAMs. Two versions of burst mode operation, 68030 Burst Mode and 68040 Burst Mode are provided to support CPUs that are capable of performing burst accesses. Both burst modes may be used with nibble, page or static column DRAMs.

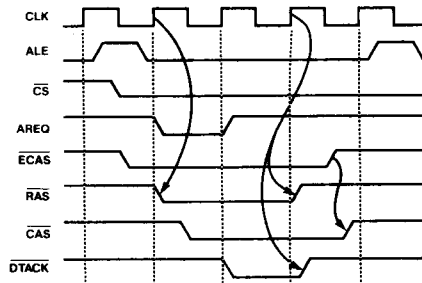
Interleaved Access Mode can provide a performance advantage when used in systems that support address pipelining. The user selects the operating mode best suited to the system's requirements by programming bits C4, C5, C6 and ECAS1-3 in the Mode Load Register.

### Single Access Mode

Single Access Mode is selected when  $\overline{ECAS1}$ ,  $\overline{ECAS2}$ ,  $\overline{ECAS3} = 0, 0, 0$  during programming. The access is initiated by two signals,  $\overline{ADS}$  (ALE) and  $\overline{CS}$ , and is terminated by one signal,  $\overline{AREQ}$ . Both RAS and DTACK are negated when the access is terminated.

The user has the option of negating  $\overline{CAS}$  when the access is terminated or up to one clock period later. If  $\overline{ECAS0} = 0$  during programming,  $\overline{CAS}$  will be negated with RAS and DTACK. If  $\overline{ECAS0} = 1$  during programming,  $\overline{CAS}$  will remain asserted until the next rising CLK edge or the rising edge of  $\overline{ECAS}$ , whichever occurs first. This allows the DRAM to continue to drive the data bus while RAS is precharging. See Figure 6.

Figure 6. Single Access Mode with Synchronous Access Start and Extended CAS



### Page Mode Access

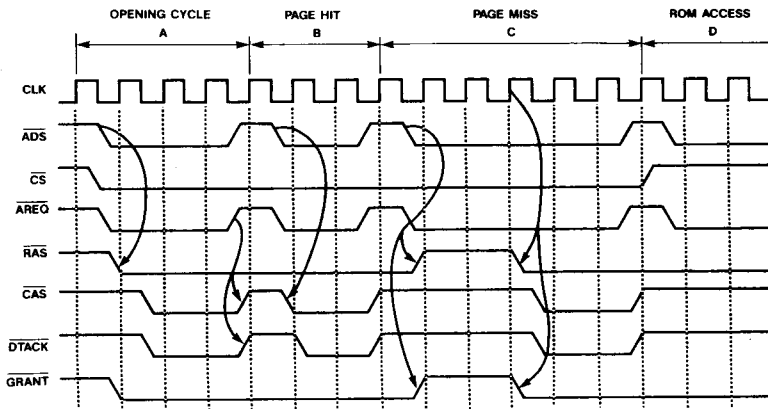
Page Mode is selected when  $\overline{ECAS1}$ ,  $\overline{ECAS2}$ ,  $\overline{ECAS3} = 0, 1, 0$  during programming. Page Mode allows the CPU to access random columns within a page without having to pay the penalties associated with RAS access and precharge time. Both page and static column mode DRAMs may be used. It is very similar in operation to the Single Access Mode, with only two notable exceptions:

- 1) Only  $\overline{CAS}$  and  $\overline{DTACK}$  are negated when  $\overline{AREQ}$  terminates the access.
- 2) The DRC maintains  $\overline{RAS}$  low even when the CPU is not accessing DRAM.

On-chip page detection logic detects page hits and misses. The DRC's on-chip wait state logic delays the assertion of  $\overline{DTACK}$  in case of a page miss to allow for RAS precharge and RAS access time. An external signal,  $\overline{GRANT}$ , is asserted to indicate to external circuitry when the access has begun.

Several Page Mode accesses are shown in Figure 7. Access A occurred after a refresh cycle. The access was not delayed due to RAS precharge since the CPU initiated the access after the  $\overline{RAS}$  was already precharged. Access B is a page hit. Access C is a page miss. Access D is an access to a memory location other than DRAM.

Figure 7. Page Mode Accesses



When programmed for Page Mode operation ( $\overline{ECAS2} = 1$ ), the DRC maintains  $\overline{RAS}$  and  $\overline{GRANT}$  low for 5 internal refresh requests (75  $\mu$ s). After the 5th internal refresh request, both signals will be negated when  $\overline{AREQ}$  terminates the access. The DRC will then perform a 5 refresh burst.

Certain applications may require that, at certain times, the DRAM is precharged prior to an access start. Since it is impossible to ensure that a given access will result in a page hit, and if the penalty of a page miss is intolerable,  $\overline{DISPM}$  may be used to negate  $\overline{RAS}$  when an access is completed.

If  $\overline{DISPM}$  is asserted when there is no access or refresh in progress,  $\overline{RAS}$  is negated immediately. If  $\overline{DISPM}$  is asserted during an access,  $\overline{AREQ}$  will negate both  $\overline{RAS}$  and  $\overline{CAS}$  when the access is completed. The DRC will continue to function as though it were programmed for Single Access Mode operation as long as  $\overline{DISPM}$  is asserted. After  $\overline{DISPM}$  is negated, all pending refreshes (up to 5) will be performed in a burst refresh.

When the DRC is not programmed to support error scrubbing,  $\overline{DISPM}$  has no effect on  $\overline{RAS}$  during refreshes. When the DRC is programmed to support error scrubbing,  $\overline{DISPM}$  is time multiplexed with  $\overline{EXTDRF}$ .  $\overline{EXTDRF}$  will cause the refresh  $\overline{RAS}$  to be extended when it is sampled active on the rising edge of  $\overline{CLK}$  that was programmed to negate  $\overline{RAS}$ .

## Burst Mode Accesses

In order to support high performance CPUs that can perform up to 4 memory accesses in a single burst, the KS84C31/32 is capable of performing 4 accesses when provided with the starting address of the burst. The DRC supports two forms of burst mode operation. When programmed for 68040 Burst Mode,  $\overline{CAS}$  is asserted on the falling edge of  $\overline{CLK}$  and is negated on the rising edge of  $\overline{CLK}$ . This mode should be used when the data is to be sampled on the rising edge of  $\overline{CLK}$  such as with the MC68040 and i486 CPUs. To accommodate CPU's that sample data on the falling edge of  $\overline{CLK}$ , such as the MC68030, 68030 Burst Mode should be used. In 68030 Burst Mode,  $\overline{CAS}$  is asserted on the rising edge of  $\overline{CLK}$  and is negated on the falling edge of  $\overline{CLK}$ .

The user has the choice of using nibble, page or static column DRAMs in both burst modes. An on-chip address counter may be used while bursting, if desired. The 2-bit address counter wraps around to support CPU's that wrap around when filling their cache lines. The user can

choose when to increment the address counter depending on whether page or static column DRAMs are used. The DRC's burst access can be terminated early if the CPU is performing a single access or aborts the burst.

Either burst mode may be combined with Page Mode operation to reduce the number of clock cycles required for the opening access of the burst by programming  $\overline{ECAS2} = 1$ . When programmed in combination with Page Mode,  $\overline{CAS}$  will be negated, but  $\overline{RAS}$  will remain asserted after the last access of the burst.

If  $\overline{DISPM}$  is asserted during an access, both  $\overline{RAS}$  and  $\overline{CAS}$  are negated when the access is completed. The DRC will continue to function as though it were not programmed for Page Mode ( $\overline{ECAS2} = 0$ ) as long as  $\overline{DISPM}$  is asserted. After  $\overline{DISPM}$  is negated, all pending refreshes (up to 5) will be performed in a burst refresh.

The on-chip address counter is enabled when the address latches are programmed to latch the address on the falling edge of  $\overline{ADS(ALE)}$ . If the latches are transparent, the counter is disabled. When the latches are transparent, external circuitry may be used to provide a new column address to the DRC.

If the on-chip address counter is used, the user needs to select when the counter is incremented. If static column DRAMs are used,  $R6 = 0$  should be programmed. If page mode DRAMs are used,  $R6 = 1$  may be programmed. When  $R6 = 0$ , the column address will be incremented when  $\overline{CAS}$  is negated. When  $R6 = 1$ , the column address is incremented before the access is completed, on the  $\overline{CLK}$  edge that asserts  $\overline{DTACK}$ .

The  $\overline{CAS}$  strobe is negated when the DRAM access is completed, even when static column DRAMs are used. This insures that data is not strobed into the incorrect page if a page miss occurs during a write access.

Since the  $\overline{CAS}$  propagation delay and precharge time is matched to the DRC's column address increment propagation delay, there is no performance penalty associated with bringing  $\overline{CAS}$  high.

## 68040 Burst Access Mode

68040 Burst Mode operation is selected when  $\overline{ECAS1}$ ,  $\overline{ECAS3} = 0, 1$  during programming.

When programmed for 68040 Burst Mode,  $\overline{CAS}$  is always negated by the same rising  $\overline{CLK}$  edge that negates  $\overline{DTACK}$ .  $\overline{CAS}$  is always asserted on the next falling  $\overline{CLK}$  edge unless the DRC has completed the burst or if the burst was aborted.

# KS84C31/32

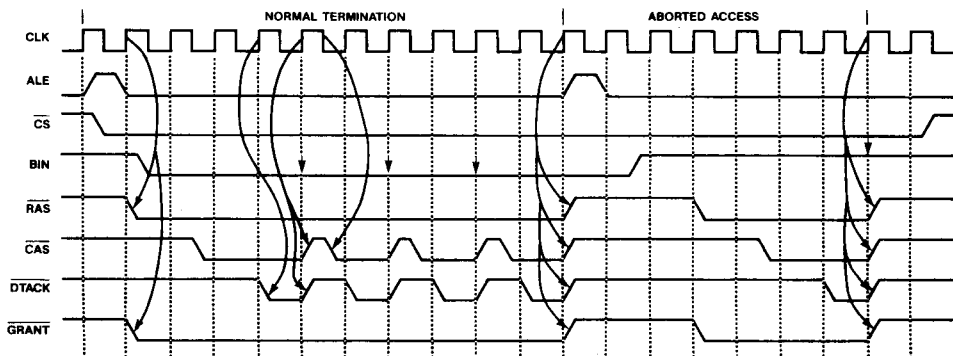
The DRC's burst can be aborted by asserting the DRC's Burst Inhibit (BIN) input. BIN is sampled on the rising edge of CLK that negates CAS and DTACK, and if asserted, the burst is aborted. Once aborted, the next access must be initiated with ADS(ALE) and CS.

Two 68040 Burst Mode accesses are shown in Figure 8. During the first access, the DRC is allowed to complete

the burst normally. The second access was deferred due to  $\overline{\text{RAS}}$  precharge. The burst was aborted during the second access by asserting BIN.

Figures 9 and 10 show the same accesses when 68040 Burst Mode is combined with Page Mode. In the case of Figures 9 and 10, the  $\overline{\text{RAS}}$  precharge is due to a page miss.

Figure 8. 68040 Burst Mode Access ( $\overline{\text{ECAS2}} = 0$  Programmed)



2

Figure 9. Burst Mode Access with Page Mode ( $\overline{\text{ECAS2}} = 1$ , R6 = 0 Programmed)

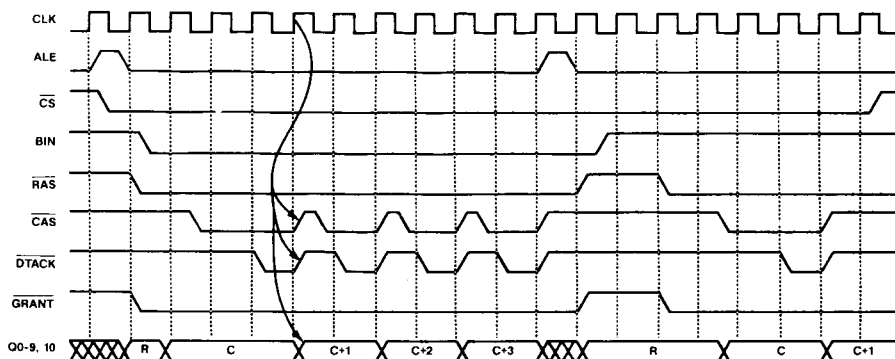
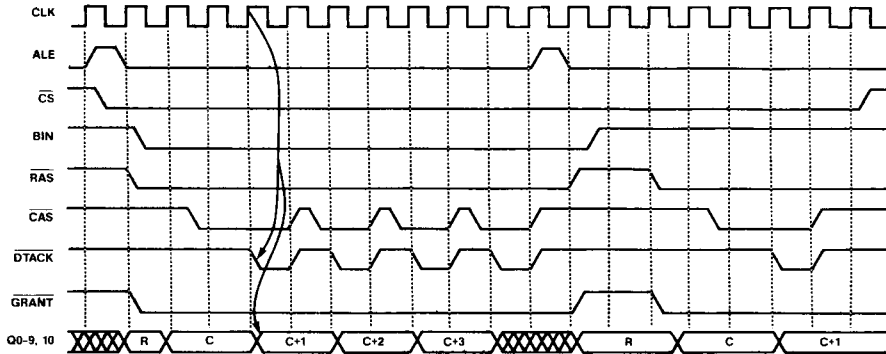


Figure 10. Burst Mode Access with Page Mode ( $\overline{ECAS2} = 1$ ,  $R6 = 1$  Programmed)



### 68030 Burst Access Mode

The MC68030's synchronous burst cache fill operation is supported by programming the DRC for 68030 Burst Mode operation. 68030 Burst Mode operation is very similar to 68040 Burst Mode operation, with only two notable exceptions:

- 1)  $\overline{CAS}$  is asserted on the rising edge of CLK and negated on the falling edge.
- 2) The handshake input  $\overline{CBREQ}$  is provided and is sampled on the rising edge of CLK that negates DTACK.

The DRC's DTACK output drives the MC68030's  $\overline{STERM}$  and  $\overline{CBACK}$  inputs.

68030 Burst Mode operation is selected when  $\overline{ECAS1}$ ,  $\overline{ECAS3} = 1, 0$  during programming.

Two 68030 Burst Mode accesses are shown in Figure 11. During the first access, the DRC is allowed to complete the burst normally. The second access was deferred due to  $\overline{RAS}$  precharge. The burst was aborted during the second access by negating  $\overline{CBREQ}$ .

Figures 12 and 13 show the same accesses when 68030 Burst Mode is combined Page Mode. In the case of Figures 12 and 13, the  $\overline{RAS}$  precharge is due to a page miss.

Figure 11. 68030 Burst Mode Access ( $\overline{ECAS2} = 0$  Programmed)

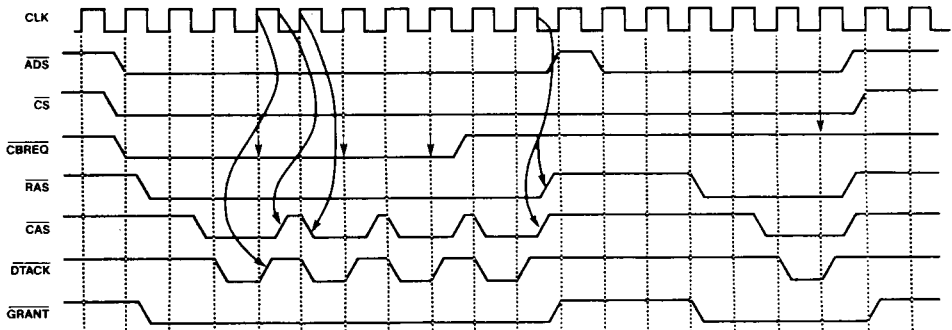
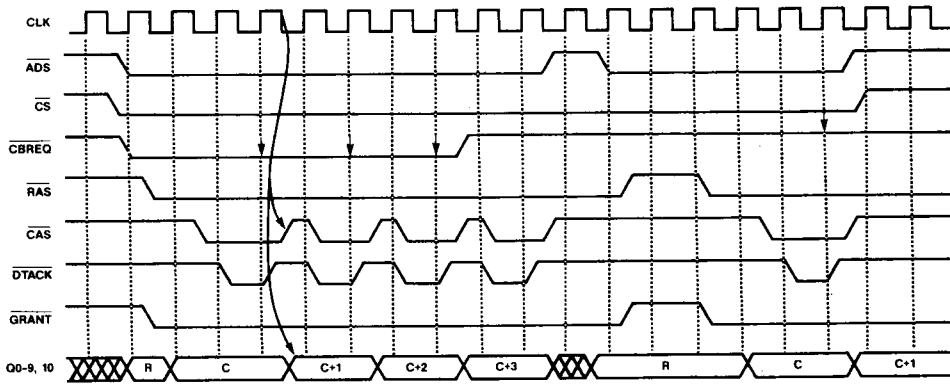
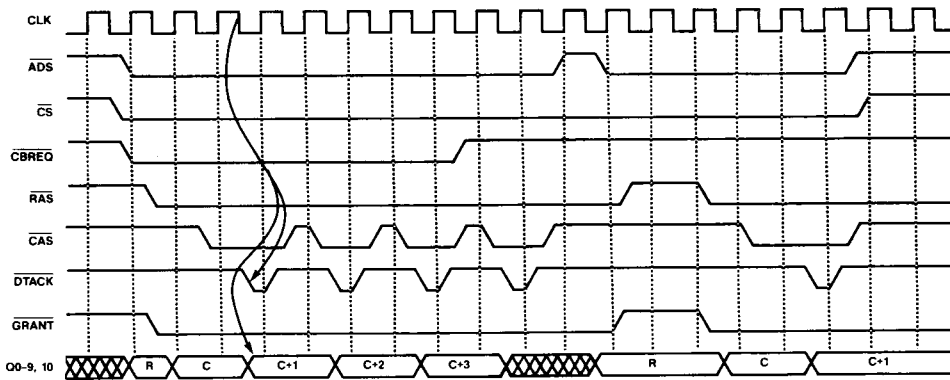


Figure 12. 68030 Burst Mode with Page Mode ( $\overline{\text{ECAS2}} = 1$ , R6 = 0 Programmed)



2

Figure 13. 68030 Burst Mode with Page Mode ( $\overline{\text{ECAS2}} = 1$ , R6 = 1 Programmed)



## Interleaved Access Modes

The KS84C31/32 supports 2 or 4-way interleaved accesses between memory banks. By interleaving accesses, performance degradation due to  $\overline{\text{RAS}}$  access and precharge time is minimized.

Interleaved Access Mode may be used in systems that support address pipelining. When interleaving accesses, the DRC supplies the next row address after the column address hold time is satisfied for the current access. If the next access is to a different bank of memory than the current access,  $\overline{\text{RAS}}$  will be asserted for the next access by ALE(ADS).

Interleaved Access Mode is selected by programming the  $\overline{\text{RAS}}$  and  $\overline{\text{CAS}}$  configuration bits C4, C5 and C6. These bits enable the DRC to initiate an access to one bank with ALE(ADS) while maintaining an access to another bank with  $\overline{\text{AREQ}}$ . *The  $\overline{\text{GRANT}}$  output should not be used in this mode.*

The ECASn bits should be programmed for Single Access Mode for proper interleaved operation. R8 = 0 should be programmed so that the DRAM controller will drive the new row address onto the bus after the column address hold time for the current access is satisfied.

Interleaved Access Mode should not be used in conjunction with page or burst mode operation. However, the  $\overline{\text{RAS}}$  precharge time is hidden in these modes if consecutive accesses hit different banks. Only one CLK of precharge will be incurred when switching banks. The programmed number of precharge clock cycles will be observed if consecutive access hit the same memory bank.

## Wait State Support

Wait states are required when a relatively slow DRAM is operating with a fast CPU. Wait states allow the CPU's bus cycle to be extended by one or more CPU clock periods. The KS84C31/32 will insert wait states during the CPU's DRAM bus access in order to:

- a) insert the desired number of wait states during the access,
- b) delay the access until the refresh in progress is complete, or
- c) delay the access to guarantee  $\overline{\text{RAS}}$  precharge time.

The DRC generates two output signals to support the insertion of wait states.  $\overline{\text{GRANT}}$  is asserted to inform external logic that the DRC has begun an access.  $\overline{\text{DTACK}}$  is asserted to terminate the access. An input signal, WAITIN, is provided to allow the user to add wait states dynamically during the access.

$\overline{\text{GRANT}}$  mimics the operation of  $\overline{\text{RAS}}$  during an access. Like  $\overline{\text{RAS}}$ , it is asserted synchronous to CLK in Mode 0 and asynchronous to CLK in Mode 1 and remains active until  $\overline{\text{RAS}}$  is negated. In case of a page miss, both  $\overline{\text{GRANT}}$  and  $\overline{\text{RAS}}$  will remain negated for at least 1T so that  $\overline{\text{GRANT}}$  may be sampled by external circuitry to determine if a page miss has occurred.  $\overline{\text{GRANT}}$  is deasserted during refresh operations.

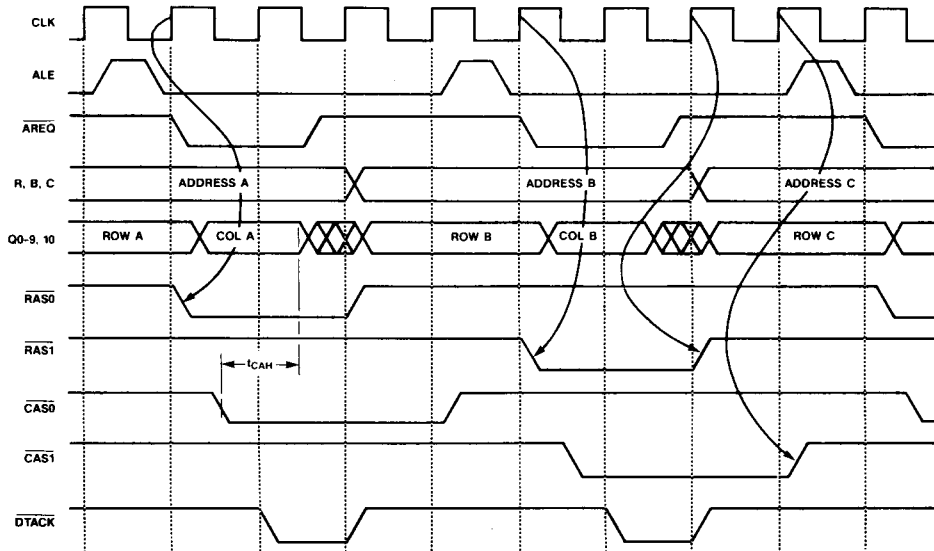
*When programmed for Page Mode operation,  $\overline{\text{GRANT}}$  will remain asserted for two rising edges of CLK after ADS is asserted while the DRC is arbitrating between the access and the 5th internal refresh request (See Automatic Internal Burst Refreshing).*

$\overline{\text{DTACK}}$  may be programmed (via R7) to be asserted on the rising or falling CLK edge. The number of CLK edges that  $\overline{\text{DTACK}}$  is delayed, is programmable.  $\overline{\text{DTACK}}$  is controlled by programming bits R2 and R3 for any access during which  $\overline{\text{RAS}}$  is initially asserted (i.e. single accesses, page misses, etc). Programming bits R4 and R5 control  $\overline{\text{DTACK}}$  during page hits and while bursting.

Figures 15 and 16 show how  $\overline{\text{DTACK}}$  behaves in Mode 0 and 1 accesses during which  $\overline{\text{RAS}}$  is initially asserted. Figures 17 and 18 shows how  $\overline{\text{DTACK}}$  behaves during page hits.

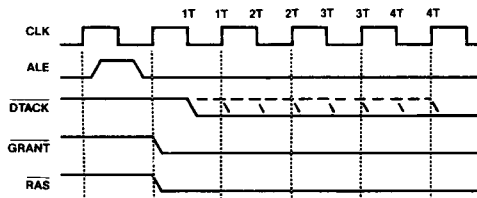


**Figure 14. 2-Way Interleaved Access Mode Operation ( $\overline{\text{ECAS0}} = 1$  Programmed)**

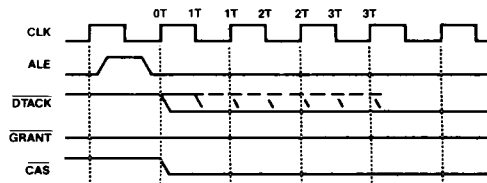


2

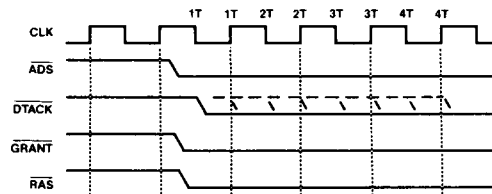
**Figure 15.  $\overline{\text{DTACK}}$  During Mode 0 Accesses,  $\overline{\text{RAS}}$  Initially Asserted**



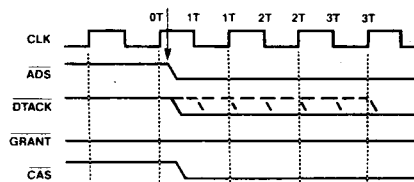
**Figure 17.  $\overline{\text{DTACK}}$  During Mode 0 Page Hits**



**Figure 16.  $\overline{\text{DTACK}}$  During Mode 1 Accesses,  $\overline{\text{RAS}}$  Initially Asserted**

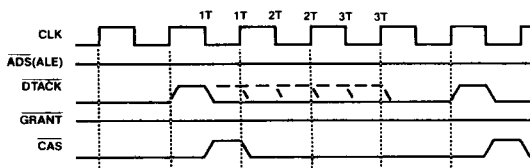


**Figure 18.  $\overline{\text{DTACK}}$  During Mode 1 Page Hits**



When used in 68040 Burst Mode or 68030 Burst Mode, the DRC should not be programmed for 0T operation for page hits and subsequent burst cycles. This will not impact memory performance, since the opening cycle of a burst access would be expected to have at least one wait state. Regardless of when DTACK is asserted, it is always negated on the next rising CLK edge in both burst modes, as shown in Figures 19 and 20.

**Figure 20. DTACK While Bursting in 68030 Burst Mode**



Any access may be extended on the fly by asserting the  $\overline{\text{WAITIN}}$  input. If  $R6 = 0$  during programming,  $\overline{\text{WAITIN}}$  is used to add one wait state during the access as shown in Figure 21.  $\overline{\text{WAITIN}}$  is sampled once during the access, when DTACK is to be asserted by the DRC. DTACK will remain negated for one more rising CLK edge if DTACK is rising edge triggered or one more falling CLK edge if DTACK is falling edge triggered.  $\overline{\text{WAITIN}}$  will not be sampled again, until the next access.

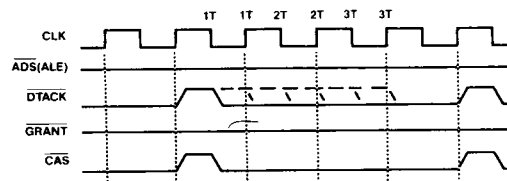
If  $R6 = 1$  during programming,  $\overline{\text{WAITIN}}$  may be used to defer DTACK indefinitely as shown in Figure 22.  $\overline{\text{WAITIN}}$  is first sampled on:

- The falling edge of  $\overline{\text{ADS}}$  (Mode 1)
- The first rising edge of CLK after ALE is pulsed high (Mode 0)
- The CLK edge that negates  $\overline{\text{DTACK}}$  while bursting

If the access start is deferred due to  $\overline{\text{RAS}}$  precharge, page hit writes or burst writes  $\overline{\text{WAITIN}}$  is sampled again on:

- The rising edge of CLK that asserts  $\overline{\text{RAS}}$  during a deferred access
- The rising edge of CLK that asserts  $\overline{\text{CAS}}$  if  $\overline{\text{CAS}}$  is delayed during page hit writes ( $C9 = 1$  programmed)
- The next rising CLK edge after the CLK edge that negates  $\overline{\text{DTACK}}$  during burst writes ( $C9 = 1$  programmed)

**Figure 19. DTACK While Bursting 68040 in Burst Mode**



The status of  $\overline{\text{WAITIN}}$  when it was last sampled takes precedence for that access.

If  $\overline{\text{WAITIN}}$  is inactive, the DRC will assert  $\overline{\text{DTACK}}$  after the programmed number of CLK edges. If  $\overline{\text{WAITIN}}$  was active, the  $\overline{\text{DTACK}}$  CLK edge count is deferred.  $\overline{\text{WAITIN}}$  will be continually sampled on the rising edge of CLK if DTACK is rising edge triggered or on the falling edge of CLK if DTACK is falling edge triggered. Once  $\overline{\text{WAITIN}}$  is negated, the DRC will assert  $\overline{\text{DTACK}}$  after the programmed number of CLK edges and will not sample  $\overline{\text{WAITIN}}$  again until the next access.

Programming bit R6 also determines when the column address is incremented in both burst modes. If  $R6 = 0$  during programming, the column address is incremented when  $\overline{\text{CAS}}$  is negated. If  $R6 = 1$  during programming, the column address is incremented when  $\overline{\text{DTACK}}$  is asserted.

Figure 21 shows a 68030 Burst Mode burst cycle. The DRC has been programmed to assert  $\overline{\text{DTACK}}$  on the second falling CLK edge after  $\overline{\text{CAS}}$  is asserted.  $\overline{\text{DTACK}}$  was held negated for 1 extra CLK period due to  $\overline{\text{WAITIN}}$ . Since  $R6 = 0$ , the column address is incremented when  $\overline{\text{CAS}}$  is negated.

Figure 21.  $\overline{\text{WAITIN}}$ , R6 = 0 Programmed

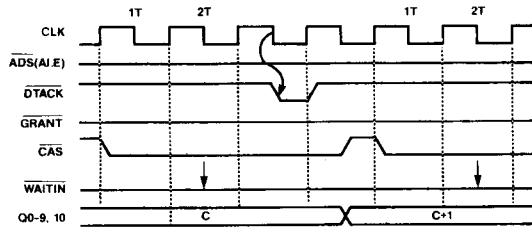


Figure 22 shows two 68040 Burst Mode burst cycles. The DRC has been programmed to assert  $\overline{\text{DTACK}}$  on the first rising CLK edge after  $\overline{\text{CAS}}$  is asserted. In the first cycle,  $\overline{\text{WAITIN}}$  was sampled active on the clock edge that negated  $\overline{\text{DTACK}}$ .  $\overline{\text{DTACK}}$  is rising edge triggered, so  $\overline{\text{WAITIN}}$  is continually sampled on rising CLK edges until it is negated. Since the DRC was programmed to assert  $\overline{\text{DTACK}}$  one rising CLK edge after  $\overline{\text{CAS}}$  was asserted,  $\overline{\text{DTACK}}$  is asserted one rising CLK edge after  $\overline{\text{WAITIN}}$  is

negated. Since  $\overline{\text{WAITIN}}$  is negated during the second burst cycle,  $\overline{\text{DTACK}}$  is asserted on the first rising CLK edge after  $\overline{\text{CAS}}$  is asserted.

Since R6 = 1, the column address is incremented when  $\overline{\text{DTACK}}$  is asserted.

Figures 23 through 25 show when  $\overline{\text{WAITIN}}$  is sampled during deferred accesses, page hit writes, and burst writes, respectively.

Figure 22.  $\overline{\text{WAITIN}}$ , R6 = 1 Programmed

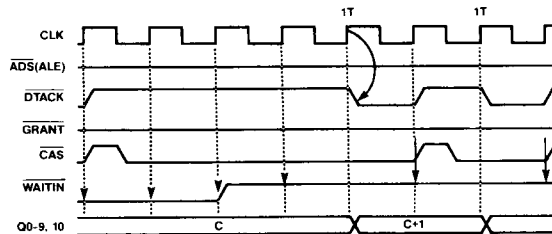


Figure 23.  $\overline{\text{WAITIN}}$ , R6 = 1 During Programming, Deferred Access Start

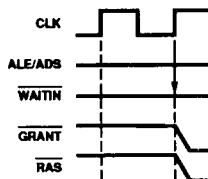


Figure 24.  $\overline{\text{WAITIN}}$ , R6 = 1 During Programming, Delay CAS During Page Hit Writes

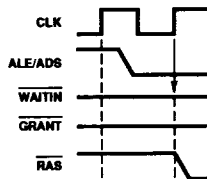
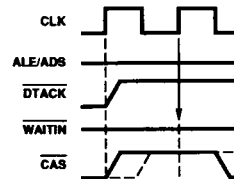


Figure 25.  $\overline{\text{WAITIN}}$ , R6 = 1 During Programming, Delay CAS During Burst Writes



## REFRESH OPERATIONS

The DRC supports four refresh control mode options:

- 1) internal automatic refreshing
- 2) internal automatic burst refreshing
- 3) externally controlled/burst refreshing
- 4) refresh request/acknowledge burst refreshing

With each of the control modes above,  $\overline{\text{RAS}}$  only refresh, or error scrubbing with  $\overline{\text{RAS}}$  only refresh may be performed.

Three inputs, extend refresh ( $\overline{\text{EXTDRF}}$ ), refresh ( $\overline{\text{RFSH}}$ ) and disable refresh ( $\overline{\text{DISRFSH}}$ ), along with two outputs, refresh in progress ( $\overline{\text{RFIP}}$ ) and refresh request ( $\overline{\text{RFRQ}}$ ) are associated with refreshing.

$\overline{\text{DISRFSH}}$  and  $\overline{\text{RFSH}}$  are used in the externally controlled/burst refresh mode and the refresh request/acknowledge mode. External circuitry asserts  $\overline{\text{DISRFSH}}$  to inhibit internally requested refreshes and requests refreshes by asserting  $\overline{\text{RFSH}}$ .

$\overline{\text{RFRQ}}$  is used in the refresh request/acknowledge mode. The DRC asserts  $\overline{\text{RFRQ}}$  to request a refresh cycle but will not perform the refresh until external circuitry acknowledges the request by asserting  $\overline{\text{RFSH}}$  as long as  $\overline{\text{DISRFSH}}$  is asserted.

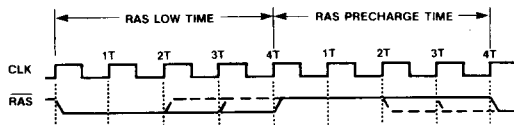
$\overline{\text{RFIP}}$  is used in all refresh modes. The DRC asserts  $\overline{\text{RFIP}}$  to indicate to external circuitry that a refresh is in progress.

$\overline{\text{EXTDRF}}$  is used when the DRC is programmed for error scrubbing. External circuitry asserts  $\overline{\text{EXTDRF}}$  to extend the refresh cycle.

The internal refresh row counter will be incremented automatically, regardless of the refresh control mode used. The refresh address counter will be incremented once all of the refresh RASs have been negated. The refresh counter may be reset by asserting  $\overline{\text{RFSH}}$  while  $\overline{\text{DISRFSH}}$  is high.

In every combination of refresh control mode and type, the DRC will assert the refresh RASs for a programmed number of CLK periods. CLK edges for  $\overline{\text{RAS}}$  low time during refresh and  $\overline{\text{RAS}}$  precharge time are counted as shown in Figure 26.

Figure 26.  $\overline{\text{RAS}}$  Low and Precharge Time



## REFRESH CONTROL MODES

### Automatic Internal Refresh

The DRC has an internal refresh clock to generate internal refresh requests. An internal refresh request is generated every period of the refresh clock.  $\overline{RFRQ}$  is pulsed once every period of the refresh clock. The refresh clock period is programmed according to the value of address bits C0-C3. The internal refresh request will generate an automatic internal refresh as long as a DRAM access is not currently in progress and the  $\overline{RAS}$  precharge time has been met. If a DRAM access is in progress when the refresh timer requests a refresh, the on-chip arbitration logic will allow the access to finish before the refresh is initiated. The next DRAM access is deferred until the refresh cycle is complete.

The refresh period for most DRAMs is 15  $\mu$ s. This means that a 1 Mbit DRAM has to be refreshed every 8 ms, during which time, 512 rows must be accessed. This requires a 9-bit row address refresh counter. The KS84C31 has a 10-bit counter and the KS84C32, an 11-bit counter. The extra bits are used for error scrubbing over the entire address range.

Automatic internal refresh is possible in Single Access, Interleaved Access and both burst modes. When the DRC is operated in Page Mode or either burst mode with Page Mode, an enhanced version of automatic internal refreshing is available as shown in the next section.

*$\overline{DISRFSH}$  must be negated to enable automatic internal refreshes.*

### Automatic Internal Burst Refreshing

The  $\overline{RAS}$  pulse width,  $t_{RASP}$  and  $t_{RASC}$ , of most page and static column DRAMs is limited to 100  $\mu$ s. The DRC takes advantage of this characteristic by supporting automatic internal burst refreshing. When operating in automatic internal burst refresh control mode, the DRC will perform a 5-refresh burst after the 5th internal refresh request (approximately every 75  $\mu$ s) instead of performing a refresh after every internal request, as in the automatic internal refresh control mode.

*$\overline{DISRFSH}$  must be negated to enable automatic internal burst refreshes. However, if  $\overline{DISRFSH}$  is asserted for any reason, all pending refreshes (up to 5) will be performed when  $\overline{DISRFSH}$  is again negated. While  $\overline{DISRFSH}$  is asserted, no internal refresh requests will accumulate.*

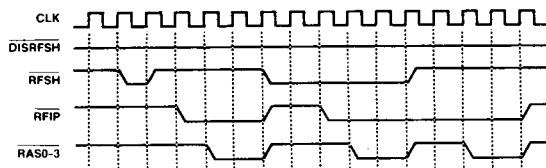
### Externally Controlled/Burst Refresh

When using externally controlled/burst refresh, internally generated refresh requests are ignored. Instead, external circuitry is used to pulse the refresh ( $\overline{RFSH}$ ) signal low to generate a refresh request. The refresh cycle will take place on the next positive edge of CLK. If a DRAM access is in progress or the  $\overline{RAS}$  precharge time has not been satisfied, the refresh will be delayed. This means that the access  $\overline{RAS}$  must be negated with  $\overline{DISPM}$  if ECAS2 = 1 is programmed in order to precharge  $\overline{RAS}$  before the refresh can take place. If  $\overline{RFSH}$  is asserted when the refresh  $\overline{RAS}$  is negated,  $\overline{RFP}$  will remain asserted and another refresh cycle will be performed after  $\overline{RAS}$  has been precharged.

Figure 27 shows how  $\overline{DISRFSH}$  and  $\overline{RFSH}$  are used to control single and burst refreshes. The DRC is performing a  $\overline{RAS}$  only refresh under external control and has been programmed to assert the refresh  $\overline{RAS}$  for 2T and to precharge  $\overline{RAS}$  for 2T.

2

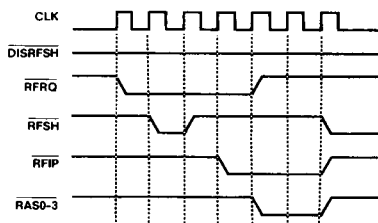
Figure 27. Externally Controlled/Burst Refresh



## Refresh Request/Acknowledge Burst Refreshing

In this refresh control mode, internally generated refresh requests are ignored by the DRC. Instead, external circuitry monitors the the DRC's  $\overline{\text{RFRQ}}$  output and generates a refresh request at the appropriate time by pulsing  $\overline{\text{RFSH}}$ . The refresh is then performed as shown in Figure 28.

Figure 28. Refresh Request/Acknowledge Refresh



## REFRESH TYPES

The DRC supports two types of refreshing:

- 1)  $\overline{\text{RAS}}$  only
- 2)  $\overline{\text{RAS}}$  only with Error Scrubbing

Each refreshing type may be controlled by any refresh control mode. The DRC asserts all  $\overline{\text{RAS}}$ s at the same time when performing  $\overline{\text{RAS}}$  only refreshing as shown in Figure 27.

$\overline{\text{RAS}}$  and  $\overline{\text{CAS}}$  are asserted during refresh when Error Scrubbing refresh is programmed as shown in Figure 48. *The  $\overline{\text{ECAS}}$  inputs do not enable or disable  $\overline{\text{CAS}}$  during the refresh. The EDAC circuit should control the DRAMs' output enable lines to avoid bus contention if the DRAM has common I/O.*

## RESET

The KS84C31/32 on-chip power-up reset logic generates a reset pulse:

- At power up
- If  $V_{\text{CC}}$  falls well below 3V and reaches  $V_{\text{CC min}}$ .

When the chip is reset, the Mode Register (with the exception of bit C6, which is set) and all internal counters are reset. All of the output signals are inactive;  $\overline{\text{RAS0-3}}$ ,  $\overline{\text{CAS0-3}}$ ,  $\overline{\text{DTACK}}$ ,  $\overline{\text{RFP}}$ ,  $\overline{\text{WE}}$ ,  $\overline{\text{RFRQ}}$  and  $\overline{\text{GRANT}}$  are high while Q0-9, 10 are low.

After power-up, the DRC is operable after 200  $\mu\text{s}$  and the Mode Register can be programmed if the programmable version of the chip is being used.

The Mode Load signal ( $\overline{\text{ML}}$ ) can be used to reset the chip at any time after power-up. When  $\overline{\text{ML}}$  is driven low, all internal counters are reset and the Mode Register is enabled to receive the mode bit inputs.

The internal refresh interval counter may be reset at any time by asserting  $\overline{\text{RFSH}}$  while  $\overline{\text{DISRFSH}}$  is high.

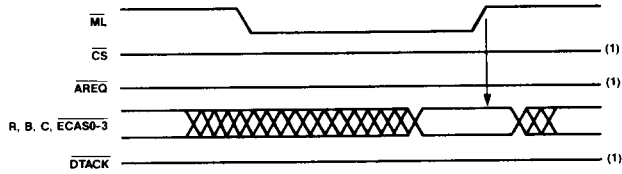
## PROGRAMMING THE KS84C31/32

The KS84C31/32 has a Mode Register that is programmed by the user. The Mode Register controls the internal operating modes of the DRC.

The DRC is programmed via the system's address bus, not the data bus. The Mode Register receives inputs from the CPU on address lines R0-9 and C0-9, the bank select lines B0 and B1, and the  $\overline{\text{CAS}}$  enable lines  $\overline{\text{ECAS0-3}}$ . The Mode Register is enabled by the falling edge of  $\overline{\text{ML}}$ . The inputs are then strobed in on the rising edge of  $\overline{\text{ML}}$  as show in Figure 29.

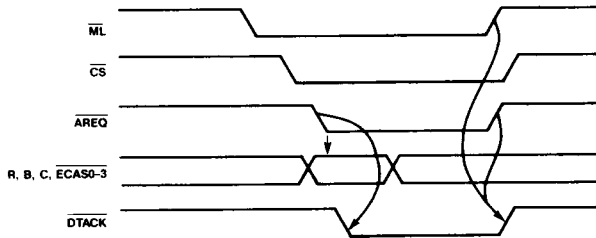
Alternatively, the Mode Register may be programmed by initiating a "fake" access as shown in Figure 30. When programmed in this fashion,  $\overline{\text{ML}}$  and  $\overline{\text{CS}}$  are asserted, followed by  $\overline{\text{AREQ}}$ . The programming inputs are strobed into the Mode Load Register on the falling edge of  $\overline{\text{AREQ}}$ .  $\overline{\text{DTACK}}$  is asserted on the falling edge of  $\overline{\text{AREQ}}$  to terminate the bus access and is negated by the rising edge of  $\overline{\text{ML}}$  or  $\overline{\text{AREQ}}$  (whichever occurs first).

Figure 29. Mode Load Only Programming



2

Figure 30. Fake Access Programming



**Table 4. Programming the Mode Register**

OPERATING MODES										
ECAS1-3	<p>These bits program the DRCs operating mode. The user has the choice of Single Access Mode, Interleaved Access Mode, Page Access Mode, 68040 Burst Access Mode with or without Page Mode or 68030 Burst Access Mode with or without Page Mode. Interleaved Access Mode is selected by the <math>\overline{RAS}</math> and <math>\overline{CAS}</math> configuration bits C4, C5, and C6.</p>									
	ECAS1	ECAS2	ECAS3							
	0	0	0							
	0	1	0							
	0	0	1							
	0	1	1							
	1	0	0							
	1	1	0							
<table border="1"> <thead> <tr> <th>Operating Mode</th> </tr> </thead> <tbody> <tr> <td>Single Access Mode</td> </tr> <tr> <td>Page Access Mode</td> </tr> <tr> <td>68040 Burst Access Mode</td> </tr> <tr> <td>68040 Burst Access Mode with Page Mode</td> </tr> <tr> <td>68030 Burst Access Mode</td> </tr> <tr> <td>68030 Burst Access Mode with Page Mode</td> </tr> </tbody> </table>				Operating Mode	Single Access Mode	Page Access Mode	68040 Burst Access Mode	68040 Burst Access Mode with Page Mode	68030 Burst Access Mode	68030 Burst Access Mode with Page Mode
Operating Mode										
Single Access Mode										
Page Access Mode										
68040 Burst Access Mode										
68040 Burst Access Mode with Page Mode										
68030 Burst Access Mode										
68030 Burst Access Mode with Page Mode										
ADDRESS LATCH/AUTOMATIC COLUMN INCREMENT WHILE BURSTING										
B0	<p>B0 allows the user to specify whether the on-chip latches should latch the address inputs on the falling edge of <math>\overline{ADS}</math>(ALE) or whether they should remain transparent. If <math>\overline{ECAS2} = 1</math> during programming the row address is always latched by the on-chip page detect logic regardless of how B0 is programmed.</p> <p>The user also specifies whether the DRC automatically increments the column address while bursting or if external circuitry is required to change the column address. If B0 = 0 during programming, then the column address is automatically incremented while bursting. If B0 = 1, the address latches will remain transparent, disabling the automatic column increment.</p>									
	B0		Automatic Column Increment							
	0	Address Bits Latched	Enabled							
	1	Address Latches Transparent	Disabled							
ACCESS START AND TERMINATION MODES										
B1	<p>B1 allows the user to specify either synchronous or asynchronous access start and termination modes.</p> <p>A synchronous (Mode 0) access is controlled by the system clock. The access is initiated on the first rising CLK edge after ALE goes high. <math>\overline{AREQ}</math> is sampled on rising CLK edges and terminates the access when it is negated.</p> <p>An asynchronous (Mode 1) access is initiated immediately by the falling edge of <math>\overline{ADS}</math> and is immediately terminated by the rising edge of <math>\overline{AREQ}</math>.</p>									
	B1									
	0	Mode 0								
	1	Mode 1								



**Table 4. Programming the Mode Register (Continued)**

<b>RAS LOW AND RAS PRECHARGE TIME</b>																						
R0, R1	<p>These bits control the time that <math>\overline{\text{RAS}}</math> is low during refresh operations and also determine the <math>\overline{\text{RAS}}</math> precharge time. The time interval shown (T) is equivalent to one rising CLK edge. The user should take into account <math>\overline{\text{RAS}}</math> rise and fall time when programming these bits.</p> <table border="1"> <thead> <tr> <th>R0</th> <th>R1</th> <th>RAS Low Time</th> <th>RAS Precharge Time</th> </tr> </thead> <tbody> <tr> <td>0</td> <td>0</td> <td>2T</td> <td>2T</td> </tr> <tr> <td>0</td> <td>1</td> <td>2T</td> <td>3T</td> </tr> <tr> <td>1</td> <td>0</td> <td>3T</td> <td>3T</td> </tr> <tr> <td>1</td> <td>1</td> <td>4T</td> <td>4T</td> </tr> </tbody> </table>		R0	R1	RAS Low Time	RAS Precharge Time	0	0	2T	2T	0	1	2T	3T	1	0	3T	3T	1	1	4T	4T
R0	R1	RAS Low Time	RAS Precharge Time																			
0	0	2T	2T																			
0	1	2T	3T																			
1	0	3T	3T																			
1	1	4T	4T																			
<b>DTACK GENERATION FOR ACCESSES THAT INITIALLY ASSERT RAS</b>																						
R2, R3	<p>These bits control <math>\overline{\text{DTACK}}</math> generation for any access during which <math>\overline{\text{RAS}}</math> is initiated. R2 and R3 determine the number of CLK edges that <math>\overline{\text{DTACK}}</math> remains negated under the following conditions:</p> <ul style="list-style-type: none"> <li>• All accesses when the DRC is programmed for Single or Interleaved Access Modes</li> <li>• During page misses and deferred accesses when the DRC is programmed for Page Mode</li> <li>• During the opening cycle of a burst access when the DRC is programmed for 68040 Burst or 68030 Burst Access Modes or if a page miss occurs during the opening access when they are combined with Page Mode.</li> </ul> <p>The time interval shown (T) refers to one rising or falling CLK edge. Bit R7 determines whether <math>\overline{\text{DTACK}}</math> is asserted on rising or falling CLK edges.</p> <table border="1"> <thead> <tr> <th>R2</th> <th>R3</th> <th>DTACK Low From Access Start</th> </tr> </thead> <tbody> <tr> <td>0</td> <td>0</td> <td>1T</td> </tr> <tr> <td>0</td> <td>1</td> <td>2T</td> </tr> <tr> <td>1</td> <td>0</td> <td>3T</td> </tr> <tr> <td>1</td> <td>1</td> <td>4T</td> </tr> </tbody> </table>		R2	R3	DTACK Low From Access Start	0	0	1T	0	1	2T	1	0	3T	1	1	4T					
R2	R3	DTACK Low From Access Start																				
0	0	1T																				
0	1	2T																				
1	0	3T																				
1	1	4T																				
<b>DTACK GENERATION FOR PAGE HITS AND BURST ACCESSES</b>																						
R4, R5	<p>These bits control <math>\overline{\text{DTACK}}</math> generation for any access during which only <math>\overline{\text{CAS}}</math> is initiated. R4 and R5 determine the number of CLK edges that <math>\overline{\text{DTACK}}</math> remains negated under the following conditions:</p> <ul style="list-style-type: none"> <li>• During page hits when the DRC is programmed for Page Mode</li> <li>• During the opening cycle of a burst access that results in a page hit when the DRC is programmed for 68040 Burst or 68030 Burst Access Modes and Page Mode is used.</li> <li>• While Bursting</li> </ul> <p>The time interval shown (T) refers to one rising or falling CLK edge. Bit R7 determines whether <math>\overline{\text{DTACK}}</math> is asserted on rising or falling CLK edges.</p> <table border="1"> <thead> <tr> <th>R4</th> <th>R5</th> <th>DTACK Low From Access Start</th> </tr> </thead> <tbody> <tr> <td>0</td> <td>0</td> <td>0T</td> </tr> <tr> <td>0</td> <td>1</td> <td>1T</td> </tr> <tr> <td>1</td> <td>0</td> <td>2T</td> </tr> <tr> <td>1</td> <td>1</td> <td>3T</td> </tr> </tbody> </table>		R4	R5	DTACK Low From Access Start	0	0	0T	0	1	1T	1	0	2T	1	1	3T					
R4	R5	DTACK Low From Access Start																				
0	0	0T																				
0	1	1T																				
1	0	2T																				
1	1	3T																				

**Table 4. Programming the Mode Register (Continued)**

PROGRAMMING WAITIN FOR WAIT STATE INSERTION AND COLUMN INCREMENT				
R6	R6 controls the functionality of WAITIN in all operating modes. It also determines when the column address will be incremented when the DRC is operated in 68040 Burst and 68030 Burst Modes.			
	R6	WAITIN Functionality	Column Address Increment	
	0	Add 1 wait state if active.	Increment when $\overline{CAS}$ is negated	
1	Continually add wait states.	Increment when DTACK is asserted		
PROGRAMMING DTACK FOR RISING OR FALLING CLK EDGES				
R7	This bit controls whether DTACK is asserted (and WAITIN is sampled) on rising or falling CLK edges.			
	R7	DTACK		
	0	Rising Edge Triggered		
1	Falling Edge Triggered			
INTERLEAVING				
R8	R8 determines whether the Q outputs are driven in interleaved or non-interleaved mode.			
	In interleaved mode, the row addresses are multiplexed to the DRAM controller address outputs, after the column addresses have been held for a sufficient time (25ns minimum) after $\overline{CAS}$ has gone low.			
	In non-interleaved mode, the column addresses are held on the DRAM controller address outputs until $\overline{CAS}$ goes high.			
R8				
0	Interleaved mode			
1	Non-interleaved mode			
RESERVED BIT				
R9	This bit should be programmed = 0. If programmed = 1, Error Scrubbing is not supported.			
RFCLK DIVISOR				
C0, C1, C2	These bits allow the user to select the divisor for the refresh clock (RFCLK) input, from which the internal refresh clock is generated. Select the divisor such that the internal refresh clock frequency is approximately 2 MHz.			
	C0	C1	C2	Divisor
	0	0	0	10
	0	0	1	6
	0	1	0	8
	0	1	1	4
	1	0	0	9
	1	0	1	5
	1	1	0	7
	1	1	1	3

Table 4. Programming the Mode Register (Continued)

INTERNAL REFRESH CLOCK DIVISOR							
C3	C3 allows the user to divide the internal refresh clock to achieve the desired interval between internally generated refresh requests.						
	C3	Divisor	Refresh Interval if Internal Refresh Clock Frequency is 2 MHz				
	0	30	15 $\mu$ s				
1	26	13 $\mu$ s					
RAS AND CAS CONFIGURATIONS							
C4, C5, C6	These bits control the $\overline{\text{RAS}}$ and $\overline{\text{CAS}}$ configurations. There are 4 $\overline{\text{RAS}}$ and 4 $\overline{\text{CAS}}$ outputs. They can always be grouped such that each $\overline{\text{RAS}}$ and $\overline{\text{CAS}}$ will drive one fourth of the memory array, regardless of whether the array is arranged in 1, 2 or 4 banks. The setting of these bits also determines whether error scrubbing and Interleaved Access Mode are selected.						
C4	C5	C6	RAS and Configuration Modes			Error Scrubbing	Interleaved Access Mode
0	0	0	RAS0-3 are brought low during an access. CAS0-3 are all selected during an access but only those enabled by the corresponding ECAS can go low. B0 and B1 are not used.			Yes	No
0	0	1	RAS pairs are selected by B1. CAS0-3 are all selected during an access but only those enabled by the corresponding ECAS can go low.			No	No
			B1	B0			
			0	X	RAS0, 1		
			1	X	RAS2, 3		
0	1	0	RAS, CAS pairs are selected by B0 and B1. A selected CAS will go low only if enabled by its corresponding ECAS.			Yes	Yes
			B1	B0			
			0	0	RAS0, CAS0		
			0	1	RAS1, CAS1		
			1	0	RAS2, CAS2		
			1	1	RAS3, CAS3		
0	1	1	RAS is selected by B0 and B1. CAS0-3 are all selected during an access but only those enabled by the corresponding ECAS can go low.			No	No
			B1	B0			
			0	0	RAS0		
			0	1	RAS1		
			1	0	RAS2		
			1	1	RAS3		
1	0	0	RAS, CAS pairs are selected by B1. A selected CAS will go low only if enabled by its corresponding ECAS.			Yes	Yes
			B1	B0			
			0	X	RAS0, 1 and CAS0, 1		
			1	X	RAS2, 3 and CAS2, 3		
1	0	1	RAS, CAS pairs are selected by B1. A selected CAS will go low only if enabled by its corresponding ECAS.			No	Yes
			B1	B0			
			0	X	RAS0, 1 and CAS0, 1		
			1	X	RAS2, 3 and CAS2, 3		
1	1	0	RAS0-3 are brought low during an access. CAS0-3 are all selected during an access but only those enabled by the corresponding ECAS can go low. B0 and B1 are not used.			No	No

2

**Table 4. Programming the Mode Register (Continued)**

RAS AND CAS CONFIGURATIONS (Continued)									
	C4	C5	C6	RAS and Configuration Modes			Error Scrubbing	Interleaved Access Mode	
		1	1	1	RAS pairs are selected by B0 and B1. A selected CAS will go low only if enabled by its corresponding ECAS.	B1	B0	No	Yes
				0		0	RAS0, CAS0		
				0		1	RAS1, CAS1		
				1		0	RAS2, CAS2		
				1		1	RAS3, CAS3		
COLUMN ADDRESS SETUP TIME									
C7	C7 allows the user to specify the minimum guaranteed column address setup time ( $t_{ASC}$ ).								
	C7	$t_{ASC}$							
	0	10 ns							
	1	0 ns							
ROW ADDRESS HOLD TIME									
C8	C8 allows the user to specify the minimum guaranteed row address hold time ( $t_{RAH}$ ).								
	C8	$t_{RAH}$							
	0	18 ns							
	1	12 ns							
DELAY CAS DURING WRITE ACCESSES									
C9	<p>C9 allows the user to delay <math>\overline{CAS}</math> during write operations that result in page hits or that occur during a burst cycle. This option allows the user to insure that the data is valid at the DRAM before <math>\overline{CAS}</math> is asserted. Since the <math>\overline{CAS}</math> delay would most likely require an additional wait state during the write access, <math>\overline{DTACK}</math> may be automatically delayed.</p> <p>During Mode 1 page hits, if DELAY <math>\overline{CAS}</math> is selected, <math>\overline{CAS}</math> will be asserted on the first CLK rising edge after <math>\overline{ADS}</math> is asserted. If <math>\overline{DTACK}</math> was programmed for 0T operation, <math>\overline{DTACK}</math> will be asserted on the same CLK rising edge that asserted <math>\overline{CAS}</math>. If <math>\overline{DTACK}</math> was programmed for 1T, 2T or 3T operation, the DRC will begin counting CLK edges after <math>\overline{CAS}</math> is asserted.</p> <p>During Mode 0 page hits, if DELAY <math>\overline{CAS}</math> is selected, the assertion of both <math>\overline{CAS}</math> and <math>\overline{DTACK}</math> will be delayed one complete CLK period.</p> <p>During burst accesses, if DELAY <math>\overline{CAS}</math> is selected, the assertion of both <math>\overline{CAS}</math> and <math>\overline{DTACK}</math> will be delayed one complete CLK period.</p>								
	C9								
	0	No Delay							
	1	Delay $\overline{CAS}$							
EXTEND CAS AND SPECIFY WE OR RFRQ									
ECAS0	<p>ECAS0 allows the user to specify whether <math>\overline{CAS}</math> is extended when the DRC is programmed for Single Access Mode. This option allows the user to begin precharging RAS before the access is completed. ECAS0 also specifies whether the WE(RFRQ) pin functions as Write Enable or Refresh Request</p>								
	ECAS0								
	0	$\overline{CAS}$ is negated by $\overline{AREQ}$ .				Specify WE			
	1	$\overline{CAS}$ remains asserted until the next rising CLK edge after RAS is negated.				Specify RFRQ			

# KS84C31/32

## DC ELECTRICAL CHARACTERISTICS

### Absolute Maximum Ratings

DC Supply Voltage .....	7V	All Input and Output Voltage .....	$V_{SS} - 0.5V$ to +7V
Temperature Under Bias .....	0°C to +70°C	Power Dissipation at 40MHz .....	0.75W
Storage Temperature .....	-65°C to 150°C	E.S.D. ....	2000V

Note: If the device is used beyond the maximum rating, permanent damage may occur. Operation should be limited to those conditions specified under DC Electrical Characteristics.

### DC Electrical Characteristics ( $T_A = 0^\circ\text{C}$ to $+70^\circ\text{C}$ , $V_{CC} = 4.75\text{V}$ to $5.25\text{V}$ , $V_{SS} = 0\text{V}$ )

Symbol	Parameter	Condition	Min	Typ	Max	Units
$V_{IH}$	Input High Voltage	Tested with limited test pattern	2.0		$V_{CC}+0.5$	V
$V_{IL}$	Input Low Voltage	Tested with limited test pattern	-0.5		0.8	V
$V_{OH1}$	Q and $\overline{WE}$ Outputs	$I_{OH} = -3\text{mA}$	2.4			V
$V_{OL1}$	Q and $\overline{WE}$ Outputs	$I_{OL} = 10\text{mA}$			0.5	V
$V_{OH2}$	All outputs except Q and $\overline{WE}$	$I_{OH} = -1\text{mA}$	2.4			V
$V_{OL2}$	All outputs except Q and $\overline{WE}$	$I_{OL} = 3\text{mA}$			0.5	V
$I_{IN}$	Input Leakage Current	$V_{IN} = V_{CC}$ or $V_{SS}$			$\pm 10$	$\mu\text{A}$
$I_{ILML}$	$\overline{ML}$ Input Current	$V_{IN} = V_{SS}$			200	$\mu\text{A}$
$I_{CC1}$	Quiescent Current	CLK at 40MHz Inputs Inactive			30	mA
$I_{CC2}$	Supply Current	Inputs Active (I load = 0)		65	125	mA
$C_{IN}$	Input Capacitance	$f_{IN}$ at 1MHz		5	10	pF

2

## AC SWITCHING CHARACTERISTICS

Figure 31 shows a typical test circuit, while Figure 32 shows the output drive levels. Figures 34 through 53 provide switching characteristics for a number of typical KS84C31/32 operations:

Unless otherwise stated  $V_{CC} = 4.75\text{V}$  to  $5.25\text{V}$ ,  $0 < T_A < 70^\circ\text{C}$

Load Capacitance:	Q0-Q9, Q10	$C_L = 380\text{pF}$
	$\overline{WE}$	$C_L = 500\text{pF}$
	$\overline{RAS0-3}$ , $\overline{CAS0-3}$	$C_L = 125\text{pF}$
	All other outputs	$C_L = 50\text{pF}$

All minimum and maximum values are measured in nanoseconds.

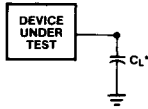
Propagation delay variance vs. load capacitance:

$\overline{RAS}$ , $\overline{CAS}$	5ns/100pF rise time
	3ns/100pF fall time
Q0-Q9, Q10	4ns/100pF rise time
	3ns/100pF fall time

# KS84C31/32

## CAPACITIVE LOAD SWITCHING

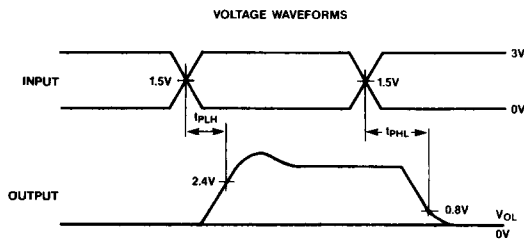
Figure 31. Switching Test Circuit



\*  $t_{PD}$  SPECIFIED AT  $C_L = 300\text{pF}$  ALL Q OUTPUTS  
 $C_L = 125\text{pF}$  RAS AND CAS OUTPUTS  
 $C_L = 500\text{pF}$  WE OUTPUTS  
 $C_L = 50\text{pF}$  ALL OTHER OUTPUTS

## TYPICAL SWITCHING CHARACTERISTICS

Figure 32. Output Drive Levels



AC Testing inputs are driven at 3.0V for a logic "1" and 0.0V for a logic "0". Timing measurements are made at 2.4V for a logic "1" and 0.8V for a logic "0" at the outputs.

Figure 33. Simplified Output Driver Schematic

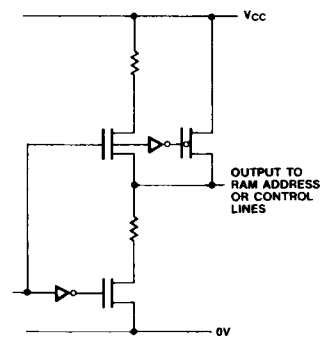


Figure 34. CLK, RFCLK Timing

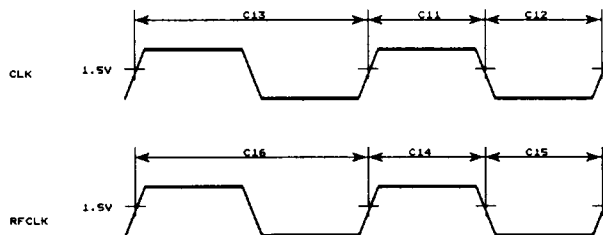








Figure 37. Page Access Mode Mode 0

MODE SETTING		
R0	0	2T 1RP
R1	0	
R2	0	1T NON BURST
R3	0	
R4	0	1T BURST
R5	1	
R6	0	ADD 1T
R7	0/1	CLK RISING/FALL
R8	1	NON INTER.
R9	X	
C0	X	
C1	X	
C2	X	
C3	X	
C4	0	RAS/CAS PAIRS
C5	1	
C6	0	
C7	X	
C8	X	
C9	X	
B0	X	
B1	0	SYN MODE 0
ECAS0	0	
ECAS1	0	
ECAS2	1	PAGE MODE
ECAS3	0	

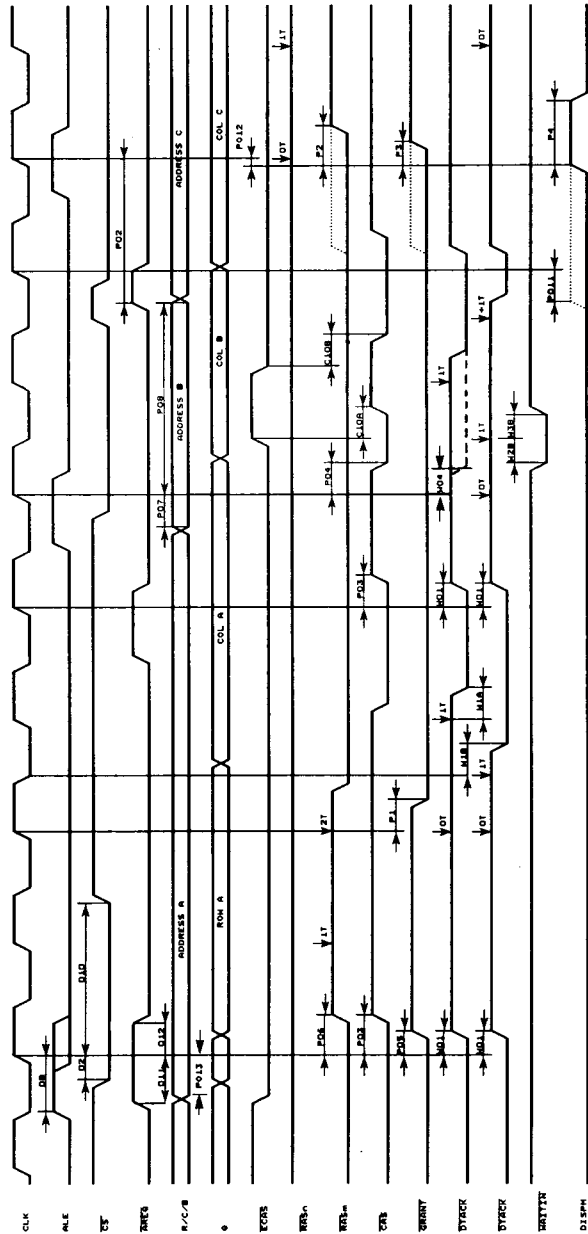
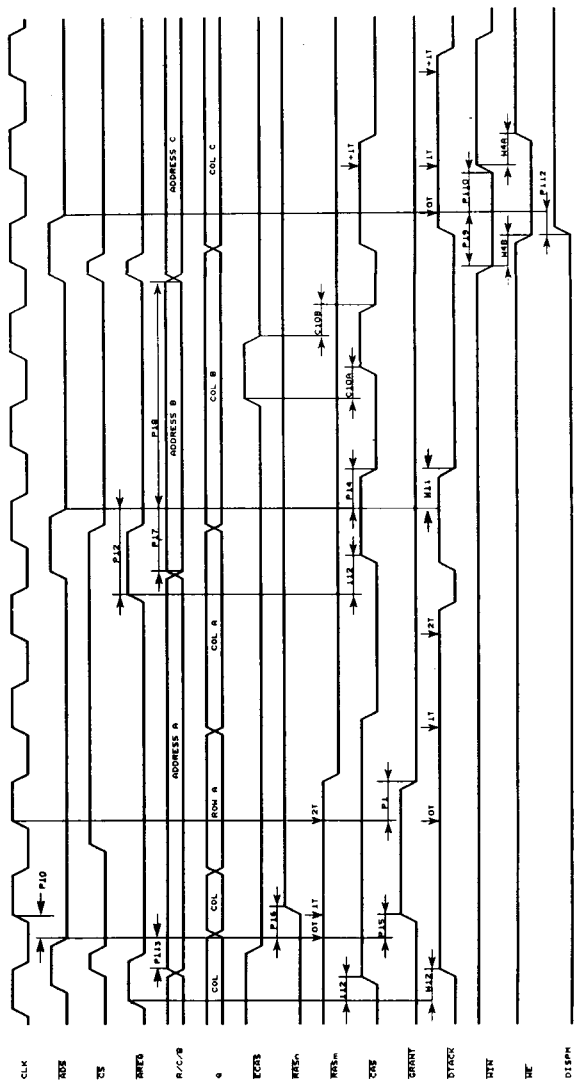


Figure 38. Page Access Mode Mode 1

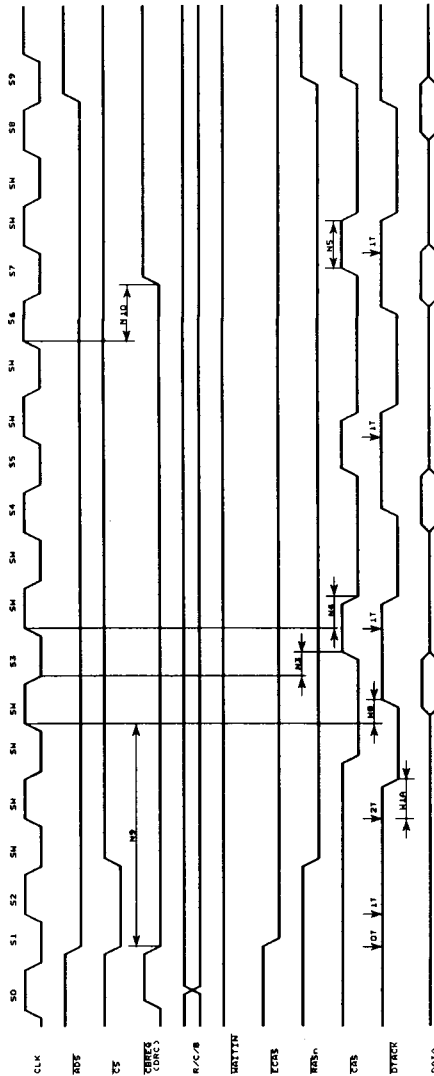
MODE SETTING		
R0	0	2T 1RP
R1	0	
R2	0	2T NON BURST
R3	1	
R4	0	1T BURST
R5	1	
R6	X	
R7	0	CLK RISING EDGE
R8	1	NON INTERL.
R9	X	
C0	X	
C1	X	
C2	X	
C3	X	
C4	0	RAS/CAS PAIRS
C5	1	
C6	0	
C7	X	
C8	X	
C9	1	DELAY CAS (MIN)
B0	X	
B1	1	ASYM MODE 1
ECAS0	0	
ECAS1	0	
ECAS2	1	PAGE MODE
ECAS3	0	



# KS84C31/32

Figure 39. 68030 Burst Access Mode

MODE SETTING		
R0	0	2T 1RP
R1	0	
R2	0	2T NON BURST
R3	1	
R4	0	1T BURST
R5	1	
R6	0	ADD 1T
R7	0	CLK RISING EDGE
R8	1	NON INTERL.
R9	X	
C0	X	
C1	X	
C2	X	
C3	X	
C4	0	RAS/CAS PAIRS
C5	1	
C6	0	
C7	X	
C8	X	
C9	X	
C0	X	
B1	1	ASYN MODE 1
ECAS0	0	
ECAS1	1	68030 MODE
ECAS2	0	
ECAS3	0	



2

# KS84C31/32

Figure 40. 68030 Burst Access Mode with Page Mode

MODE SETTING		
RQ	0	2T 1RP
RA	0	
R2	0	1T NON BURST
R3	0	
R4	0	1T BURST
R5	1	
R6	1	DEFER DIACK
R7	0	CLK RISING EDGE
R8	1	NON INTERL.
R9	X	
C0	X	
C1	X	
C2	X	
C3	X	
C4	0	RAS/CAS PAIRS
C5	1	
C6	0	
C7	X	
C8	X	
C9	X	
BD	X	
B1	1	ASYN MODE 1
ECAS0	0	
ECAS1	1	ASRD MODE
ECAS2	1	PAGE MODE
ECAS3	0	

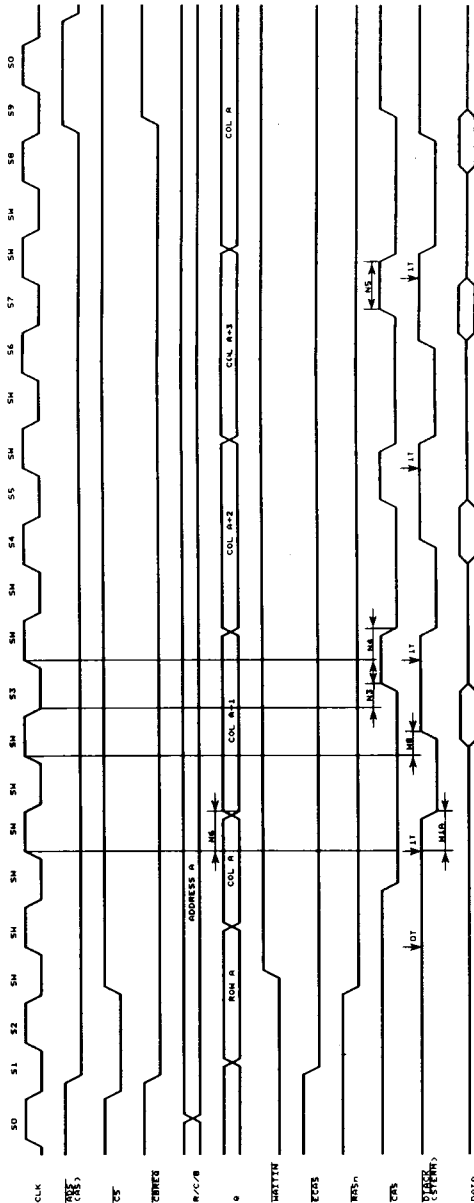


Figure 41. Burst Access Mode with Page Mode (68040, 80486)  
Mode 1

MODE SETTING		
R0	0	2T 1RP
R1	0	
R2	0	1T NON BURST
R3	0	
R4	0	1T BURST
R5	1	
R6	1	DEFER DIACK
R7	0	CLK RISING EDGE
R8	1	NON INTERNAL
R9	X	
C0	X	
C1	X	
C2	X	
C3	X	
C4	0	RAS/CAS PAIRS
C5	1	
C6	0	
C7	X	
C8	X	
C9	1	DELAY CAS (MIN)
RD	0	ADDRESS LATCH
RA	1	ASYN MODE 1
ECAS0	0	
ECAS1	0	
ECAS2	1	PAGE MODE
ECAS3	1	BURST MODE

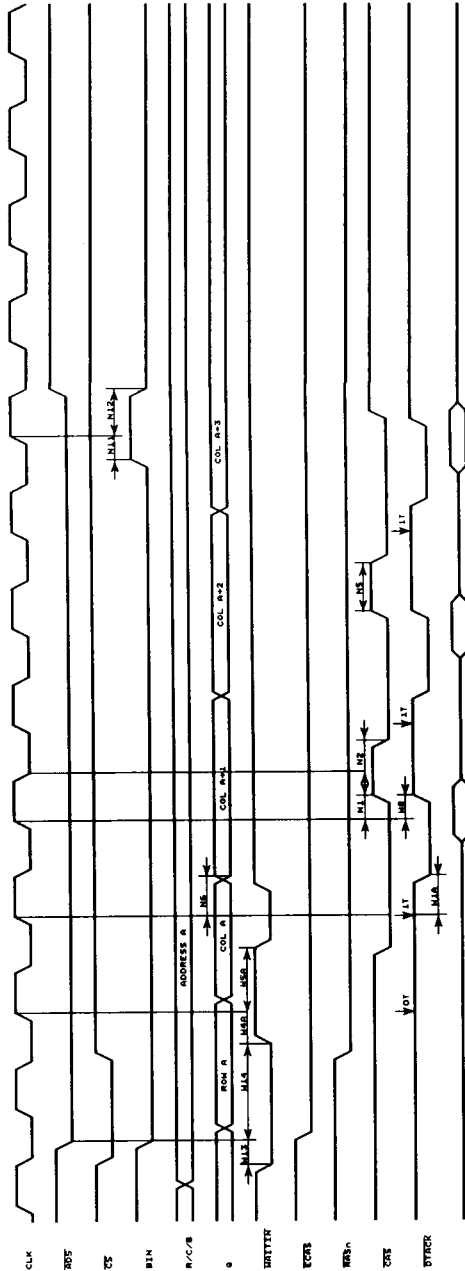
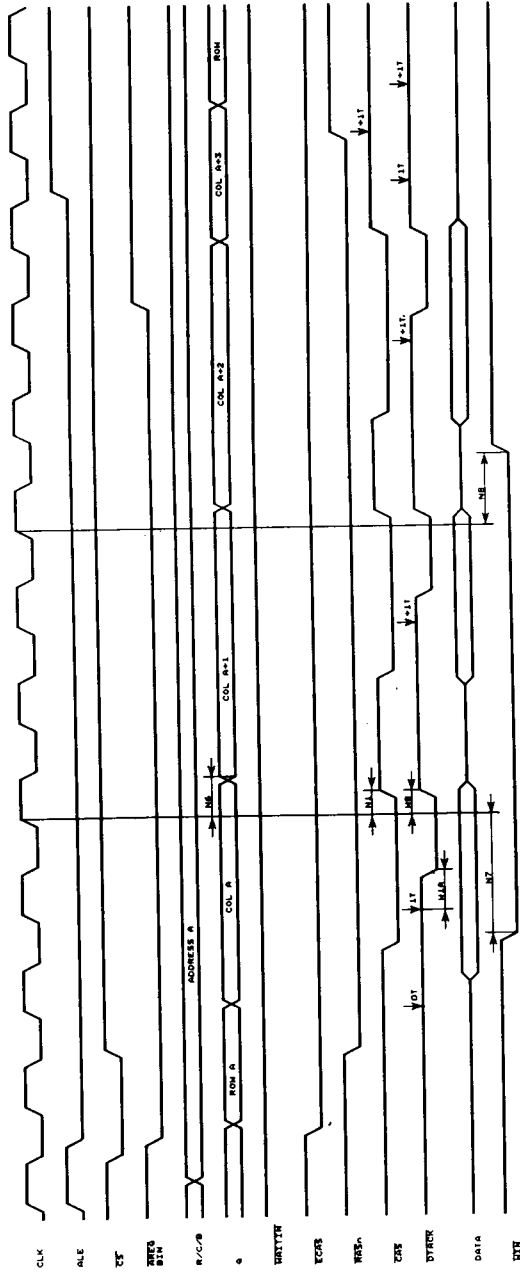


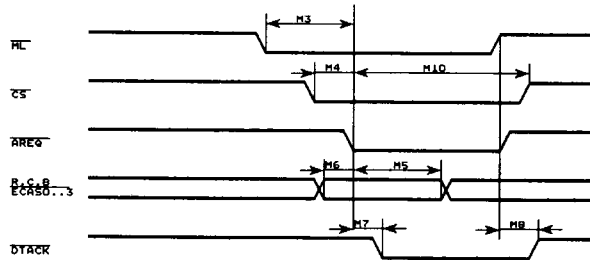


Figure 43. 68040 Burst Access Mode  
Mode 0 DELAY CAS During Burst Write

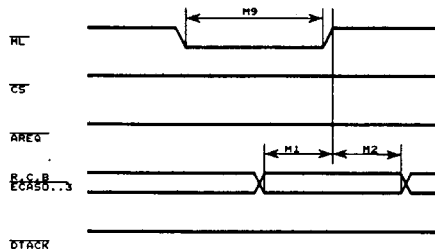
MODE SETTING		
R0	0	2T 1RP
R1	0	
R2	0	1T NON BURST
R3	0	
R4	0	1T BURST
R5	1	
R6	0	ADD 1T
R7	0	CLK RISING EDGE
R8	1	NON INTERL.
R9	X	
C0	X	
C1	X	
C2	X	
C3	X	
C4	0	RAS/CAS PAIRS
C5	1	
C6	0	
C7	X	
C8	X	
C9	1	DELAY CAS CHINA
B0	0	ADDRESS LATCH
B1	0	SYN MODE 0
ECAS0	0	
ECAS1	0	
ECAS2	0	
ECAS3	1	BURST MODE



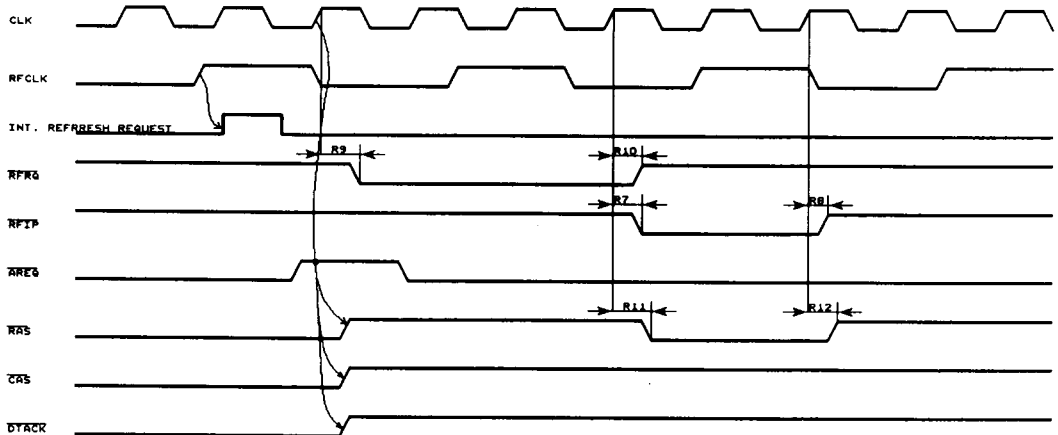
**Figure 44. Mode Load by Fake Access**



**Figure 45. Mode Load Controlled by Mode Load Input Only**

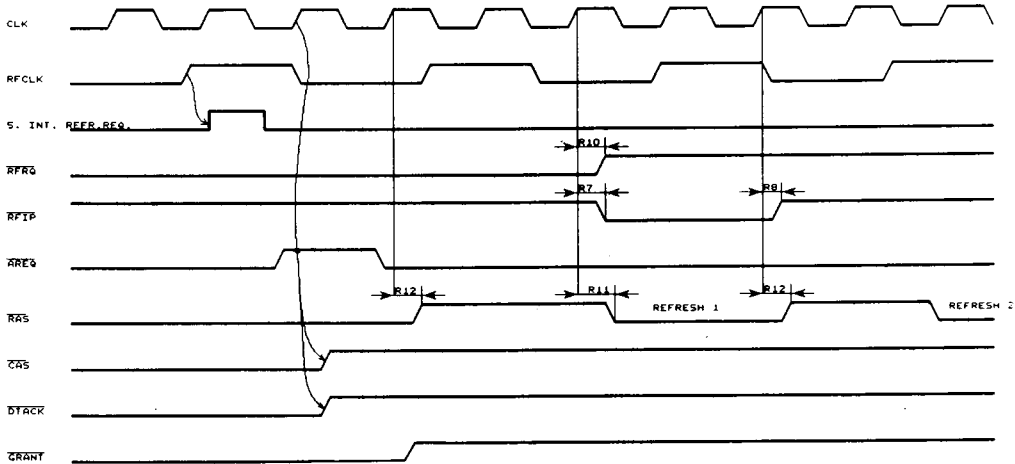


**Figure 46. REFRESH, Single Access Mode Burst Mode**



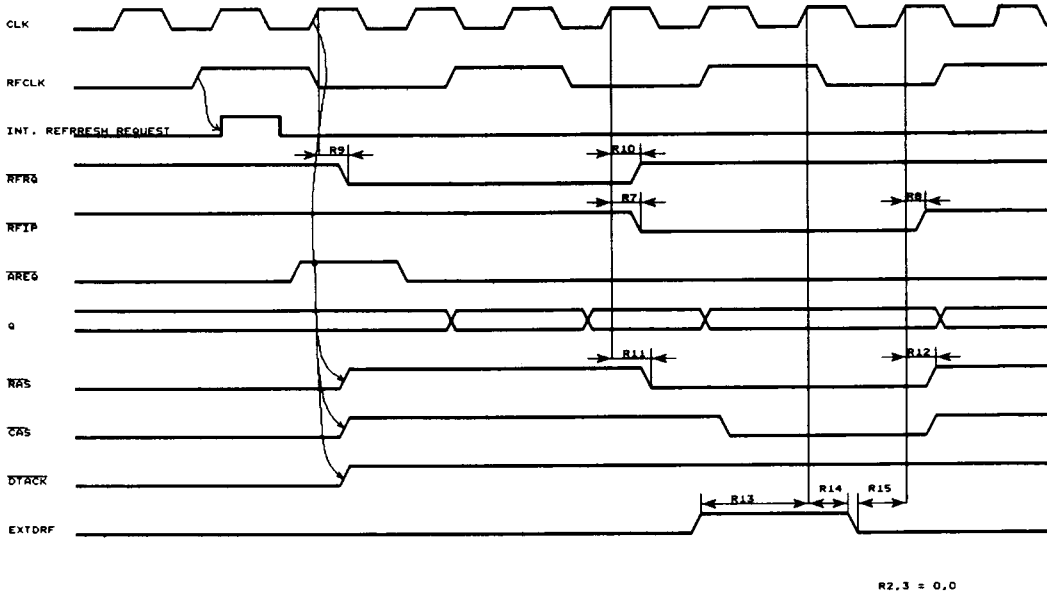


**Figure 47. REFRESH In Page Mode**



2

**Figure 48. REFRESH with Extend Refresh**



**Figure 49. Page Mode  
REFRESH with Extend Refresh**

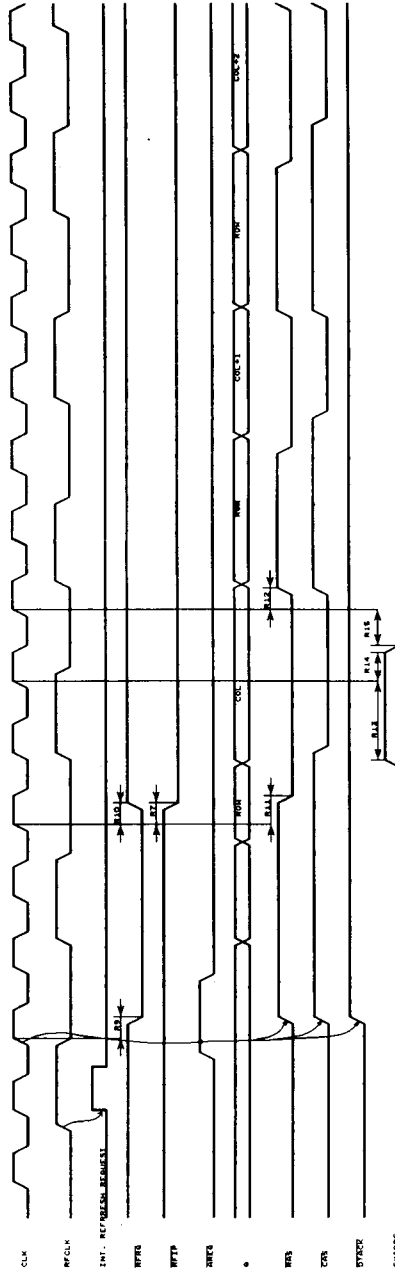
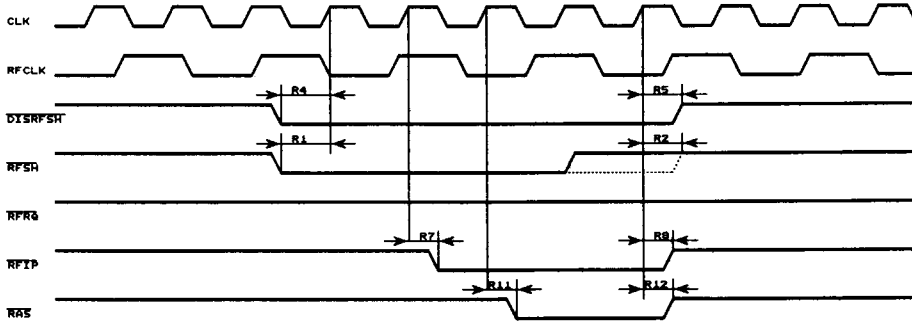


Figure 50. External Controlled Refresh



2

Figure 51. External Controlled Refresh ( $\overline{\text{ECAS0}} = '0'$ )

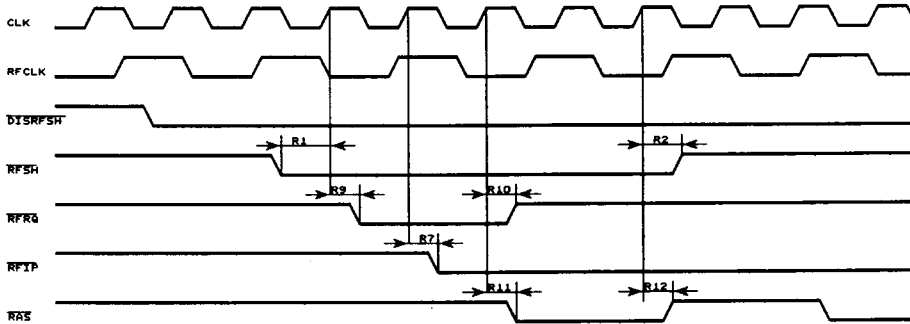


Figure 52. Page Mode — Disable Page Mode and Internal Refresh

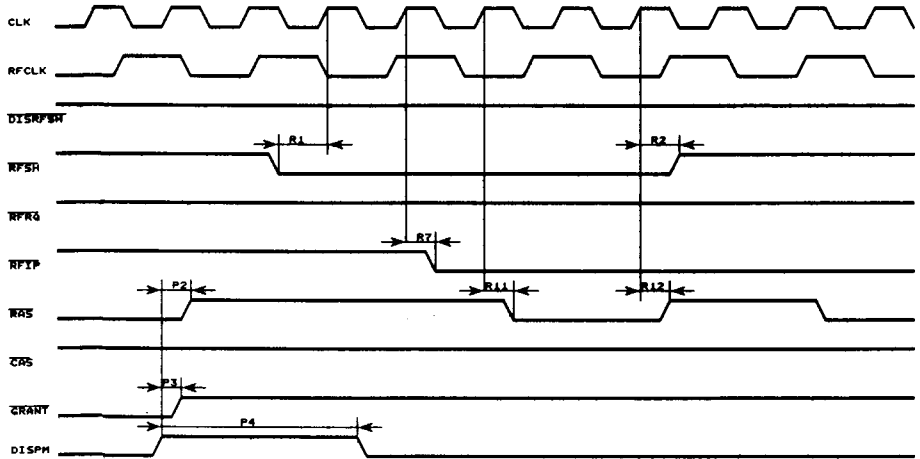
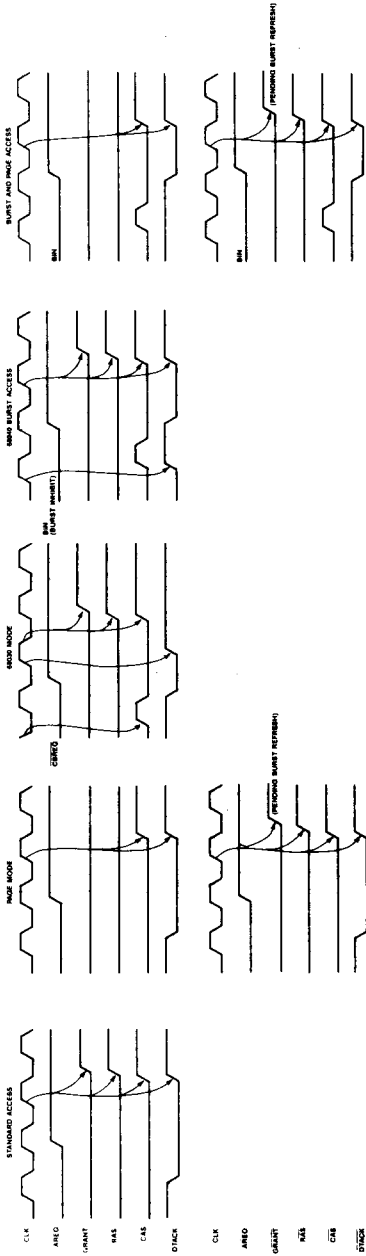
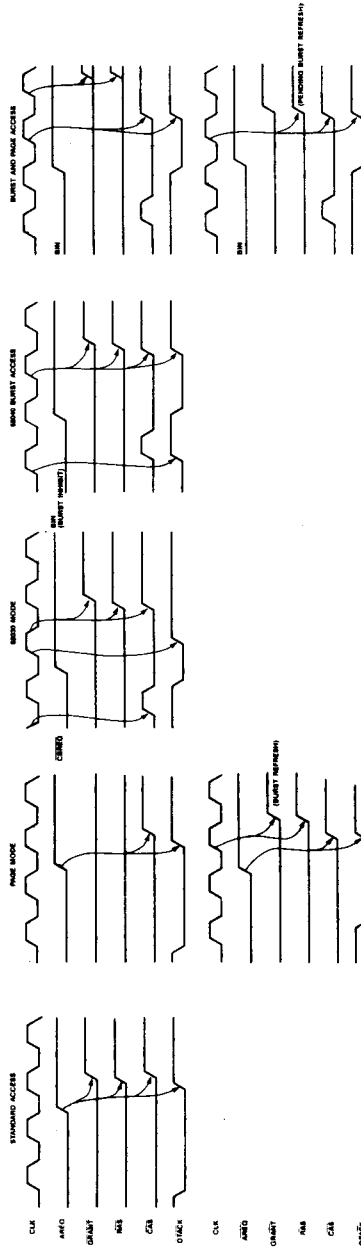


Figure 53. Access Cycle Termination

## Mode 0 (Synchronous Mode)



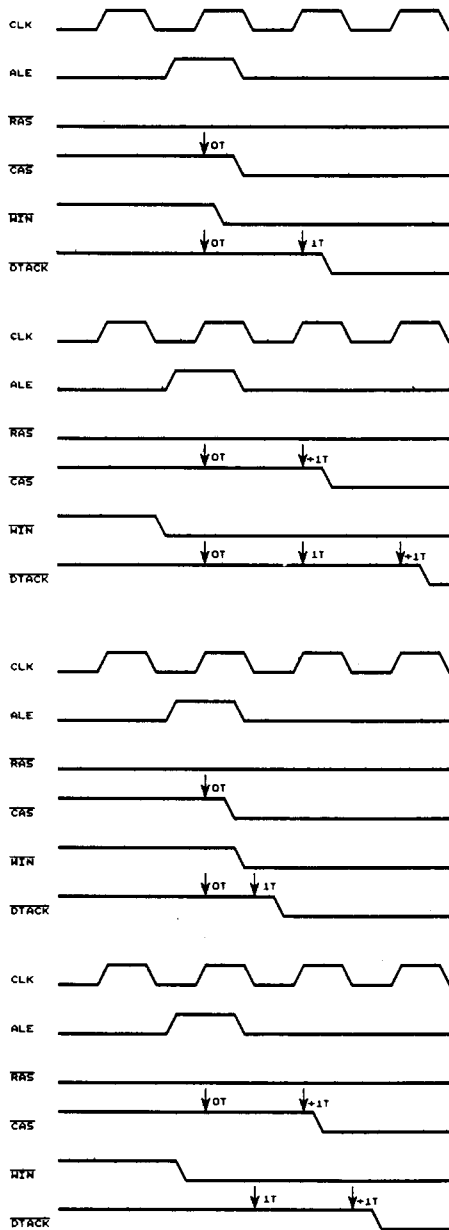
## Mode 1 (Asynchronous Mode)



# KS84C31/32

Figure 53. Access Cycle Termination (Continued)

## Page Mode — Mode 0



## Page Mode — Mode 1

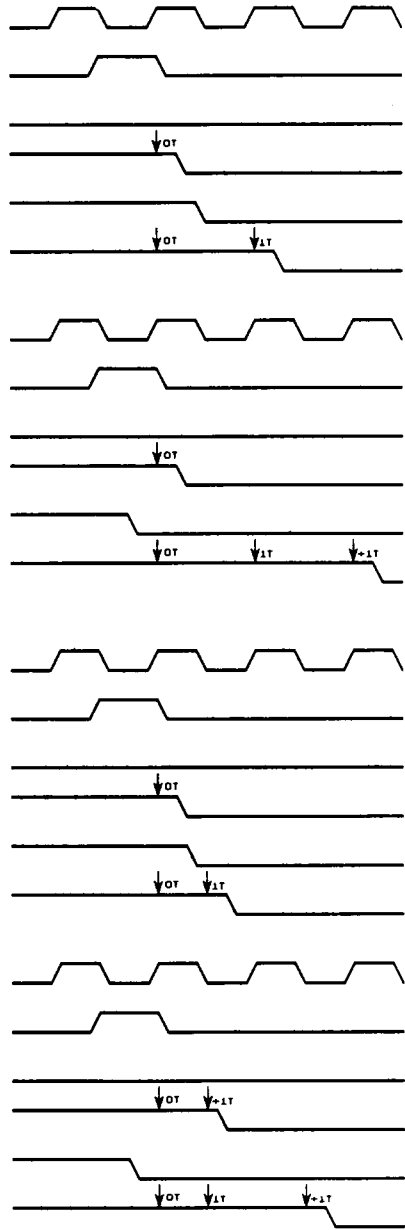
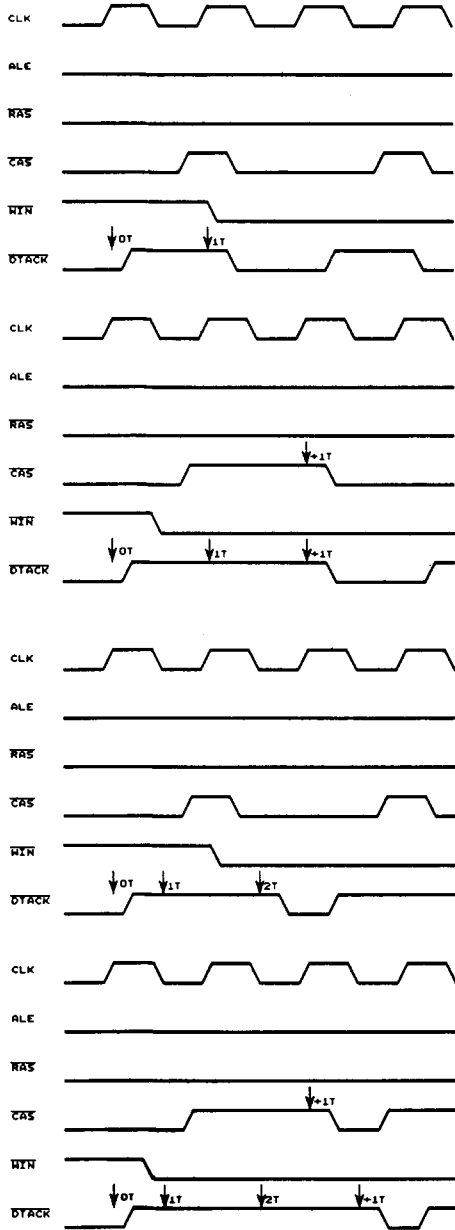
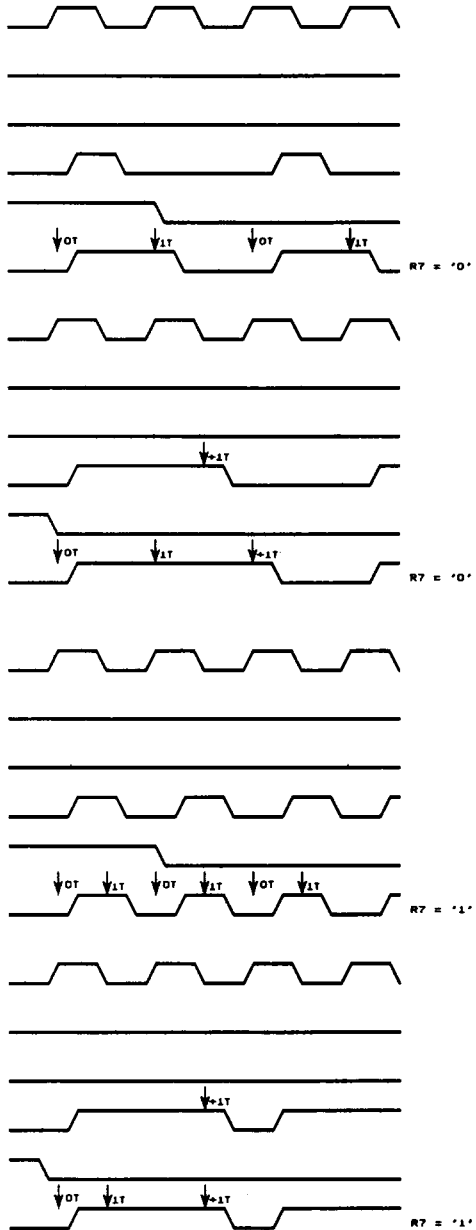


Figure 53. Access Cycle Termination (Continued)

## 68030 Mode



## 68040 Burst Mode



# KS84C31/32

Figure 53. Access Cycle Termination (Continued)

68030 Mode

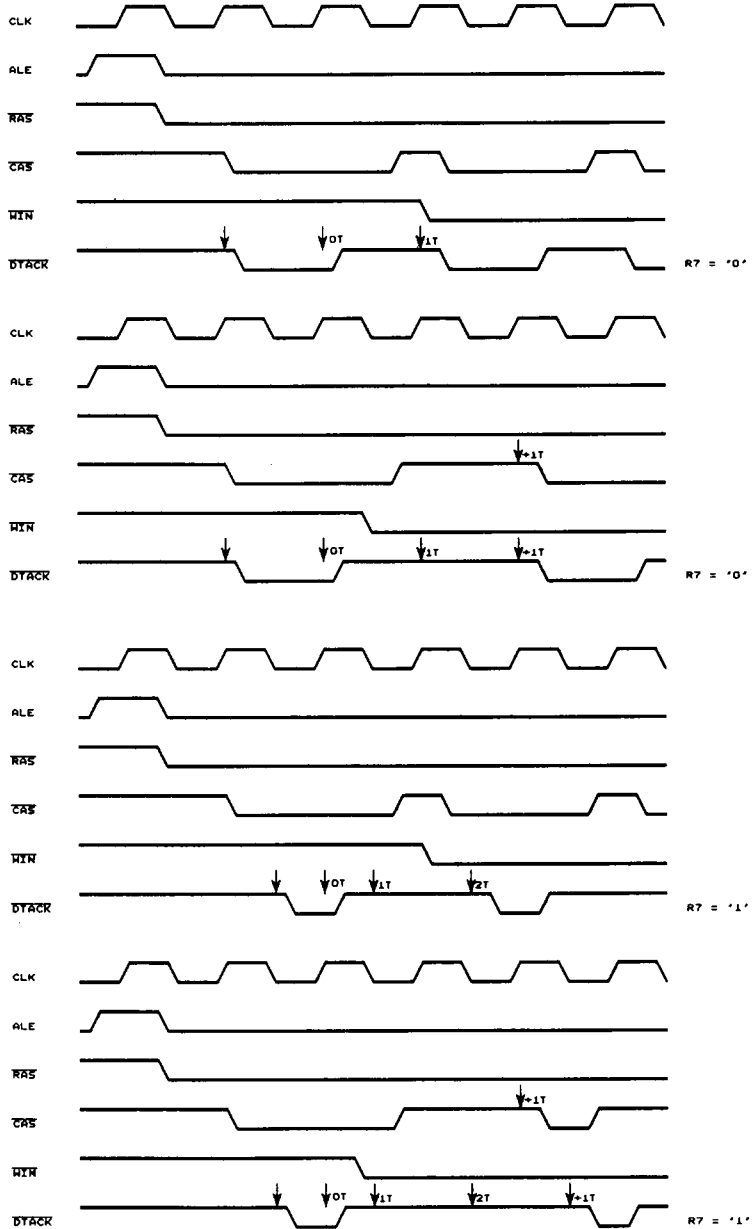
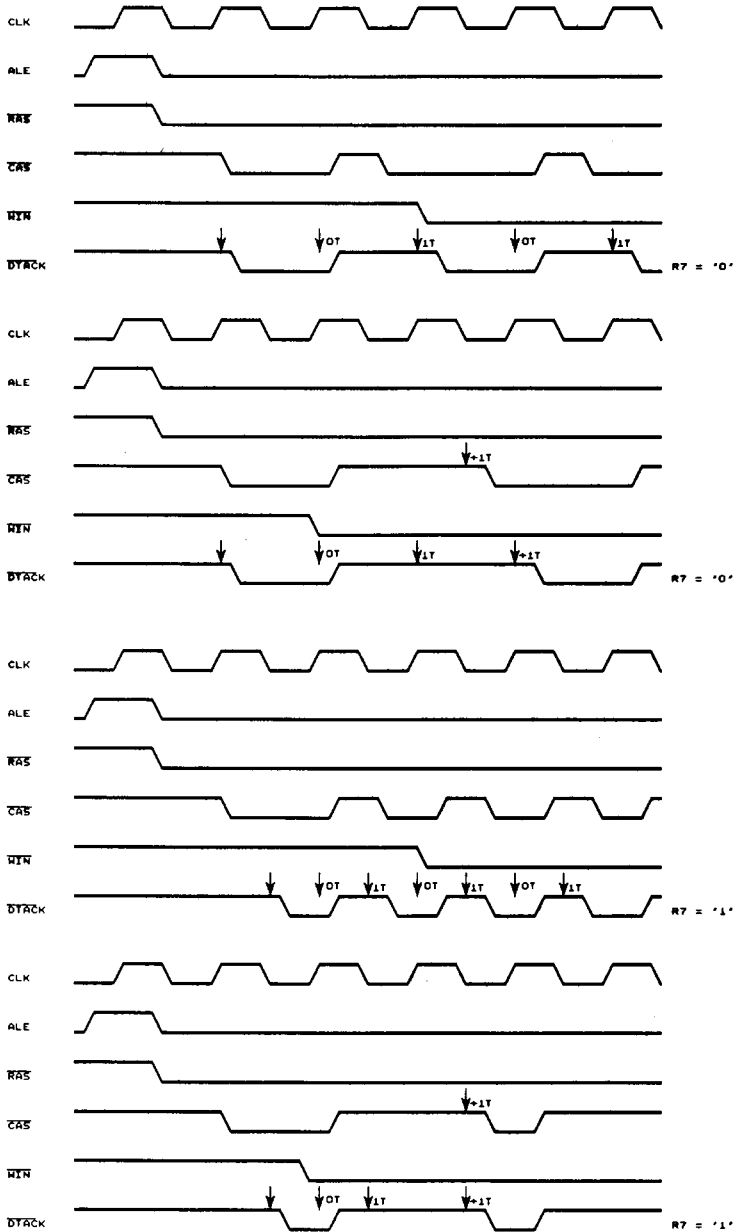




Figure 53. Access Cycle Termination (Continued)

68040 Burst Mode



# KS84C31/32

## Mode 0 Parameters

Parameter		-25		-33		-40	
		Min	Max	Min	Max	Min	Max
01	ALE minimum low time	10		10		10	
02	$\overline{CS}$ to access start setup	3		3		3	
03	Access start to $\overline{RAS}$ asserted		26		26		26
04	Address setup to access start to guarantee 0ns row address setup time	6		6		6	
05	Address hold time from ALE low when using the on chip latch	20		20		10	
06	Access start to $\overline{CAS}$ asserted $t_{RAH} = 12ns, t_{ASC} = 0ns$	49	75	49	70	49	70
	$t_{RAH} = 12ns, t_{ASC} = 10ns$	49	80	49	75	49	75
	$t_{RAH} = 18ns, t_{ASC} = 0ns$	49	80	49	75	49	75
	$t_{RAH} = 18ns, t_{ASC} = 10ns$	49	85	49	80	49	80
07	Access start to column address $t_{RAH} = 12ns$		65		60		60
	$t_{RAH} = 18ns$		75		70		70
08	ALE high to CLK rising edge	3		3		3	
09	ALE pulse width	12		10		10	
010	$\overline{CS}$ hold after access start	10		10		10	
011	$\overline{AREQ}$ to CLK rising edge setup time	12		8		3	
012	$\overline{AREQ}$ from CLK rising edge hold time	2		2		2	
014	CLK rising edge to $\overline{RAS}$ deasserted		30		25		25
015	CLK rising edge to $\overline{CAS}$ deasserted	8	27	8	23	8	23
016	CLK rising edge to $\overline{GRANT}$ deasserted		24		21		20
017	ALE negated from CLK rising edge	2		2		2	

## Mode 0 Page Mode Related Parameters

Parameter		-25		-33		-40	
		Min	Max	Min	Max	Min	Max
P01	Access start (CLK rising edge) to $\overline{GRANT}$ asserted (non-delayed access)		25		21		21
P02	$\overline{AREQ}$ high setup to access start to guarantee $\overline{CAS}$ will stay high in case of page miss	10+1T		8+1T		3+1T	
P03	$\overline{CAS}$ deasserted from CLK rising edge	8	28	8	25	8	25
P04	Access Start to $\overline{CAS}$ low if page hit	8	28	6	25	6	25
P05	$\overline{GRANT}$ high from access start in case of page miss		25		22		22
P06	$\overline{RAS}$ high from access start in case of a page miss	8	35	5	30	5	30
P07	Row and bank address set up to assure a page miss is recognized		8		6		6
P08	Row and bank address hold from access start		20		20		10
P09	WIN low set up to access start (C9 = '1')	8		6		4	
P010	WIN low hold time from access start (C9 = '1')	10		10		6	
P011	DISPM high setup to CLK rising edge	15		10		3	
P012	DISPM asserted to access start	15		10		3	
P013	Address setup to access start to guarantee 0ns column address setup time	6		6		6	

## Mode 1 Parameters

Parameter		-25		-33		-40	
		Min	Max	Min	Max	Min	Max
11							
a	Access start to CLK rising edge (R7 = '0')	12		10		7	
b	Access start to CLK falling edge (R7 = '1')	13		11		8	
12	$\overline{CS}$ to access start setup	3		3		3	
13	Access start to $\overline{RAS}$ asserted		25		24		24
14	Address setup to access start to guarantee 0ns row address setup time	10		10		10	
15	Address hold time from access start when using the on chip latch	20		20		10	
16	Access start to $\overline{CAS}$ asserted						
a	$t_{RAH} = 12ns, t_{ASC} = 0ns$	49	75	49	70	49	70
b	$t_{RAH} = 12ns, t_{ASC} = 10ns$	49	80	49	75	49	75
c	$t_{RAH} = 18ns, t_{ASC} = 0ns$	49	80	49	75	49	75
d	$t_{RAH} = 18ns, t_{ASC} = 10ns$	49	85	49	80	49	80
17	Access start to column address						
a	$t_{RAH} = 12ns$		65		60		60
b	$t_{RAH} = 18ns$		75		70		70
18	$\overline{AREQ}$ rising edge to CLK rising edge to be recognized as 1T of $\overline{RAS}$ precharge	20		17		14	
19	$\overline{ADS}$ pulse width	12		10		10	
110	$\overline{CS}$ hold after access start	10		10		10	
111	$\overline{AREQ}$ deasserted to $\overline{RAS}$ deasserted		35		30		30
112	$\overline{AREQ}$ deasserted to $\overline{CAS}$ deasserted	12	28	10	28	8	28
113	$\overline{GRANT}$ deasserted from $\overline{AREQ}$ high		28		24		20
114	$\overline{AREQ}$ asserted	10		8		8	
115	$\overline{AREQ}$ pulse width	12		10		10	
116	$\overline{AREQ}$ rising edge to access start (R8 = '1' non interleave)	15		10		10	

## Mode 1 Page Mode Related Parameters

Parameter		-25		-33		-40	
		Min	Max	Min	Max	Min	Max
P10	$\overline{ADS}$ falling edge to CLK rising edge to be recognized as 1T of $\overline{RAS}$ precharge in case of page miss	22		20		15	
P11	Access start ( $\overline{ADS}$ falling edge) to $\overline{GRANT}$ low		20		18		18
P12	$\overline{AREQ}$ high set-up to access start to guarantee $\overline{CAS}$ will stay high in case of page miss	20		15		10	
P14	Access start to $\overline{CAS}$ low if page hit	8	28	6	25	6	25
P15	$\overline{GRANT}$ high from $\overline{ADS}$ falling edge if page miss is detected		20		20		20
P16	$\overline{RAS}$ high from access start in case of a page miss		35		30		30
P17	Row and bank address set up to assure a page miss is recognized	10		10		10	
P18	Row and bank address hold from access start		20		20		10
P19	$\overline{WIN}$ low set up to access start (C9 = '1')	8		6		4	
P110	$\overline{WIN}$ low hold time from access start (C9 = '1')	7		7		6	
P112	$\overline{DISPM}$ asserted to access start	15		10		3	
P113	Address setup to access start to guarantee 0ns column address setup time	10		10		10	

# KS84C31/32

## Common Parameters

Parameter		-25		-33		-40	
		Min	Max	Min	Max	Min	Max
C1	R, C input to Q output from ALE/ADS going high	8	38	8	34	8	34
C2	R, C input to Q output	8	35	8	30	8	30
C3	Row address hold time $t_{RAH} = 12ns$	12		12		12	
	$t_{RAH} = 18ns$	18		18		18	
C4	WIN high to WE high		35		30		30
	WIN low to WE low		35		30		30
C5	Column address setup time $t_{ASC} = 0ns$	0		0		0	
	$t_{ASC} = 10ns$	10		10		10	
C6	Column address hold time (interleave only)	25	60	25	60	25	60
C7	CLK rising edge to RAS asserted after delayed access		26		26		26
C8	CLK rising edge to CAS asserted after delayed access $t_{RAH} = 12ns, t_{ASC} = 0ns$	49	75	49	70	49	70
	$t_{RAH} = 12ns, t_{ASC} = 10ns$	49	80	49	75	49	75
	$t_{RAH} = 18ns, t_{ASC} = 0ns$	49	80	49	75	49	75
	$t_{RAH} = 18ns, t_{ASC} = 10ns$	49	85	49	80	49	80
C9	CLK rising edge to CAS deasserted (mode C9 = '1')		27		23		23
C10	ECAS high to CAS high	6	25	6	20	6	20
	ECAS low to CAS low	6	25	6	20	6	20
C11	CLK high	16		14		11.5	
C12	CLK low	16		14		11.5	
C13	CLK period	40		30		25	
C14	RFCLK high	16		16		16	
C15	RFCLK low	16		16		16	
C16	RFCLK period	40		40		40	
C17	CLK rising edge to column address $t_{RAH} = 12ns$		65		60		60
	$t_{RAH} = 18ns$		75		70		70

## Common Page Mode Related Parameters

Parameter		-25		-33		-40	
		Min	Max	Min	Max	Min	Max
P1	GRANT low from access start (deferred access)		25		21		21
P2	DISPM rising edge to RAS negated		25		25		25
P3	DISPM rising edge to GRANT negated		26		23		18
P4	DISPM high pulse width	15		15		10	

## Common Wait State Parameters

Parameter			-25		-33		-40	
			Min	Max	Min	Max	Min	Max
W1	a	CLK rising edge to DTACK low (R7 = '0')	8	20	6	18	6	17
	b	CLK falling edge to DTACK low (R7 = '1')	8	20	6	18	6	18
W2	a	WAITIN setup to CLK rising edge to add 1T (R6 = '0', R7 = '0')	10		8		3	
	b	WAITIN setup to CLK falling edge to add 1T (R6 = '0', R7 = '1')	10		8		3	
W3	a	WAITIN hold time from clock rising edge (R6 = '0', R7 = '0')	5		5		5	
	b	WAITIN hold time from clock falling edge (R6 = '0', R7 = '1')	5		5		5	
W4	a	WAITIN high setup time to CLK rising edge (R6 = '1') (R7 = '0')	0		0		0	
	b	CLK falling edge (R7 = '1')	0		0		0	
W5	a	WAITIN high hold time from CLK rising edge (R6 = '1') (R7 = '0')	6		6		5	
	b	CLK falling edge (R7 = '1')	6		6		5	
W7	a	WAITIN low hold time from CLK rising edge (R6 = '1') (R7 = '0')	6		6		5	
	b	CLK falling edge (R7 = '1')	6		6		5	
W8		CLK rising edge to DTACK deasserted (burst mode)	8	20	8	18	8	17

2

## Mode 0 Wait State Parameters

Parameter			-25		-33		-40	
			Min	Max	Min	Max	Min	Max
W01		CLK rising edge to DTACK high	8	20	6	18	6	18
W02		WAITIN low setup to access start (R6 = '1')	1		1		1	
W03		WAITIN low hold time from access start (R6 = '1')	10		10		8	
W04		CLK rising edge to DTACK asserted during page hit (0T programmed)	8	22	6	20	6	20

## Mode 1 Wait State Parameters

Parameter			-25		-33		-40	
			Min	Max	Min	Max	Min	Max
W11		ADS falling edge to DTACK asserted		22		20		18
W12		AREQ rising edge to DTACK deasserted	5	20	4	18	4	15
W13		WAITIN low setup to access start (R6 = '1')	0		0		0	
W14		WAITIN low hold time from access start (R6 = '1')	8		8		8	

# KS84C31/32

## Mode Load Parameters

Parameter		-25		-33		-40	
		Min	Max	Min	Max	Min	Max
M1	Mode address setup time	5		5		5	
M2	Mode address hold time	10		10		10	
M3	$\overline{ML}$ asserted to $\overline{AREQ}$ asserted	10		10		10	
M4	$\overline{CS}$ asserted to $\overline{AREQ}$ asserted	5		5		5	
M5	Mode address hold time from $\overline{AREQ}$ asserted	20		20		20	
M6	Mode address setup time to $\overline{AREQ}$ asserted	5		5		5	
M7	$\overline{AREQ}$ asserted to $\overline{DTACK}$ asserted		20		20		20
M8	$\overline{AREQ}$ or $\overline{ML}$ deasserted to $\overline{DTACK}$ deasserted		15		15		15
M9	$\overline{ML}$ pulse width	20		20		20	
M10	$\overline{CS}$ hold time from $\overline{AREQ}$ falling edge (for "fake access")	10		10		10	

## Burst Mode Parameters

Parameter		-25		-33		-40	
		Min	Max	Min	Max	Min	Max
N1	CLK rising edge to $\overline{CAS}$ deasserted (ECAS3 = '1')	8	28	8	23	8	23
N2	CLK falling edge to $\overline{CAS}$ asserted (ECAS3 = '1')	8	25	8	20	8	20
N3	CLK falling edge to $\overline{CAS}$ deasserted (ECAS1 = '1')	8	25	8	23	8	23
N4	CLK rising edge to $\overline{CAS}$ asserted (ECAS1 = '1')	8	25	8	20	8	20
N5	$\overline{CAS}$ high pulse width	10		10		10	
N6	CLK rising/falling edge to (B0 = '0') @ $C_L$ (Q0-10) = 240pF	10	32	8	28	8	28
	Column + 1 output @ $C_L$ (Q0-10) = 380pF	10	40	8	36	8	36
N7	WIN low set up to CLK rising edge (C9 = '1')	15		10		3	
N8	WIN low hold time from CLK rising edge (C9 = '1')	5		5		3	
N9	$\overline{CBREQ}$ setup to CLK rising edge that negates $\overline{DTACK}$	10		8		4	
N10	$\overline{CBREQ}$ hold time from CLK rising edge that negates $\overline{DTACK}$	2		2		2	
N11	BIN setup to CLK rising edge	12		8		8	
N12	BIN hold time from CLK rising edge	2		2		2	

## Refresh Related Parameters

Parameter		-25		-33		-40	
		Min	Max	Min	Max	Min	Max
R1	$\overline{\text{RFSH}}$ low setup time to CLK rising edge	10		10		10	
R2	$\overline{\text{RFSH}}$ low hold time from CLK rising edge	5		5		5	
R3	$\overline{\text{RFSH}}$ pulse width for resetting refresh counter	15		15		15	
R4	$\overline{\text{DISRFSH}}$ low setup to CLK rising edge	10		10		10	
R5	$\overline{\text{DISRFSH}}$ low hold time from CLK rising edge	5		5		5	
R6	$\overline{\text{DISRFSH}}$ low pulse width	15		15		15	
R7	CLK rising edge to $\overline{\text{RFIP}}$ asserted		20		18		15
R8	CLK rising edge to $\overline{\text{RFIP}}$ deasserted		26		23		23
R9	CLK rising edge to $\overline{\text{RFRQ}}$ asserted		19		19		18
R10	CLK rising edge to $\overline{\text{RFRQ}}$ deasserted		23		19		19
R11	CLK rising edge to refresh $\overline{\text{RAS}}$ asserted		25		25		25
R12	CLK rising edge to refresh $\overline{\text{RAS}}$ deasserted		30		27		27
R13	EXTDRF setup to CLK rising edge	10		10		5	
R14	EXTDRF hold time from CLK rising edge	2		2		2	
R15	EXTDRF low setup to CLK rising edge	6		6		5	

# KS84C31/32

## PACKAGE DIMENSIONS

The Samsung KS84CXX DRAM Controllers are available in two packages. The KS84C31 68-Pin PLCC package is shown in Figure 54, while the 84-Pin version is shown in Figure 55.

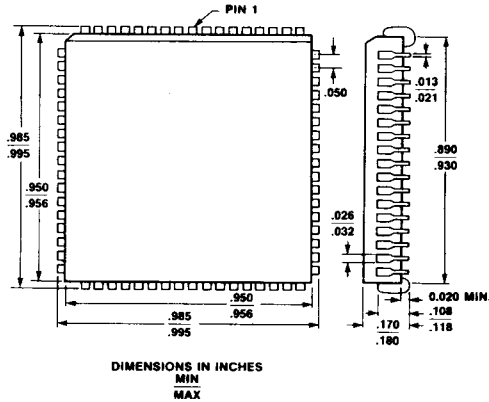


Figure 54. 68-Pin PLCC Package

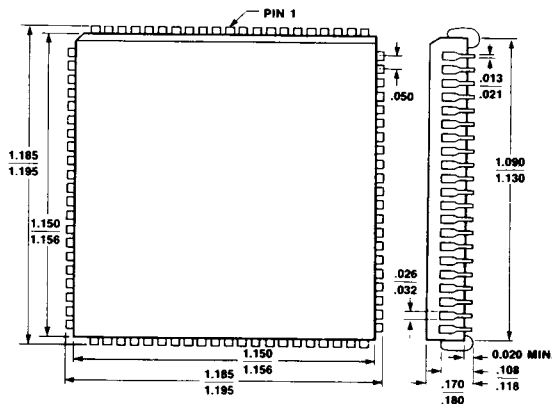
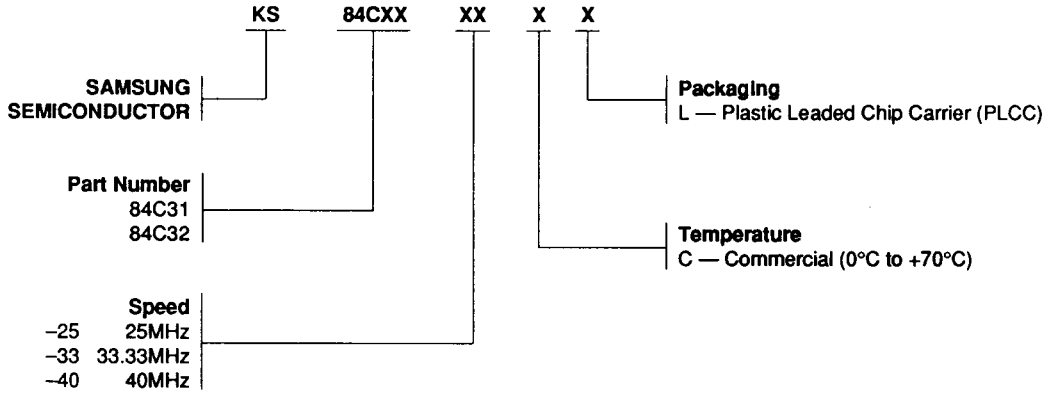


Figure 55. 84-Pin PLCC Package



# KS84C31/32

## ORDERING INFORMATION AND PRODUCT CODE



2

SAMSUNG products are designated by a Product Code. When ordering, please refer to products by their full code. For unusual, and/or specific packaging or processing requirements not covered by the standard product line, please contact the SAMSUNG MOS Product Group.

## SAMSUNG SEMICONDUCTOR, INCORPORATED SALES OFFICES

**NORTHEAST**  
20 Mall Road  
Suite 410  
Burlington, MA 01803  
617/273-4888  
FAX 617/273-9363

**NORTH CENTRAL**  
901 Warrenville Road  
Suite 120  
Lisle, IL 60532-1359  
708/852-2011  
FAX 708/852-3096

**SOUTHWEST**  
22837 Ventura Blvd.  
Suite 305  
Woodland Hills, CA 91367  
818/346-6416  
FAX 818/346-6621

**SOUTHWEST**  
Airport Exec. Suites  
2102 Business Center Dr.  
Suite 169  
Irvine, CA 92715  
(714) 253-5795  
FAX (714) 252-8842

**NORTHWEST**  
2700 Augustine Drive  
Suite 198  
Santa Clara, CA 95054  
408/727-7433  
FAX 408/727-5071

**SOUTH CENTRAL**  
15851 Dallas Parkway  
Suite 840  
Dallas, TX 75248-3307  
214/770-7970  
FAX 214/770-7971

**SOUTHEAST**  
204 Battleground Corp. Park  
3859 Battleground Ave.  
Greensboro, NC 27410  
919/282-0665  
FAX 919/282-0784

Circuit diagrams utilizing SAMSUNG and/or SAMSUNG ELECTRONICS products are included as a means of illustrating typical semiconductor applications; consequently, complete information sufficient for construction purposes is not necessarily given. The information has been carefully checked and is believed to be entirely reliable. However, no responsibility is assumed for inaccuracies. Furthermore, such information does not convey to the purchaser of the semiconductor devices described herein any license under the patent rights of SAMSUNG and/or SAMSUNG ELECTRONICS, or others. SAMSUNG and/or SAMSUNG ELECTRONICS, reserve the right to change device specifications.

### LIFE SUPPORT APPLICATIONS

SAMSUNG and/or SAMSUNG ELECTRONICS products are not designed for use in life support applications, devices, or systems where malfunction of a SAMSUNG product can reasonably be expected to result in a personal injury. SAMSUNG and/or SAMSUNG ELECTRONICS' customers using or selling SAMSUNG and/or SAMSUNG ELECTRONICS products for use in such applications do so at their own risk and agree to fully indemnify SAMSUNG and/or SAMSUNG ELECTRONICS for any damages resulting in such improper use of sale.