

# 100mΩ Power Distribution Switches

## General Description

The RT9701 is an integrated 100mΩ power switch for self-powered and bus-powered Universal Series Bus (USB) applications. A built-in charge pump is used to drive the N-channel NMOSFET that is free of parasitic body diode to eliminate any reversed current flow across the switch when it is powered off. Its low quiescent supply current (23μA) and small package (SOT-25) is particularly suitable in battery-powered portable equipment.

Several protection functions include soft start to limit inrush current during plug-in, current limiting at 1.5A to meet USB power requirement, and thermal shutdown to protect damage under over current conditions.

## Applications

- Battery-Powered Equipment
- Motherboard USB Power Switch
- USB Device Power Switch
- Hot-Plug Power Supplies
- Battery-Charger Circuits

## Ordering Information

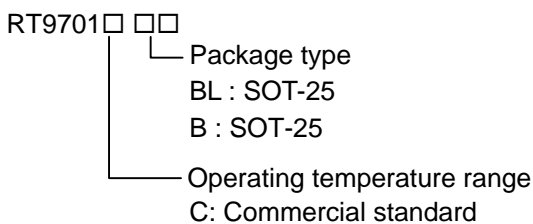

## Marking Information

Part Number	Marking
RT9701CBL	AH
RT9701CB	C0

## Features

- 100mΩ Typ. High-Side NMOSFET (SOT- 25)
- Guaranteed 1.1A Continuous Current
- 1.5A Current Limit
- Small SOT- 25 Package Minimizes Board Space
- Soft Start
- Thermal Protection
- Low 23μA Supply Current
- Wide Input Voltage Range: 2.2V ~ 6V
- UL Approved - #E219878

## Pin Configurations

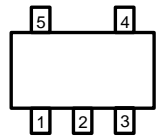
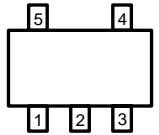
Part Number	Pin Configurations
RT9701CBL (Plastic SOT-25)	<p>TOP VIEW</p>  <p>1. VOUT 2. GND 3. VIN 4. VIN 5. VOUT</p>
RT9701CB (Plastic SOT-25)	<p>TOP VIEW</p>  <p>1. VOUT 2. GND 3. VIN 4. CE 5. VOUT</p>

## Typical Application Circuit

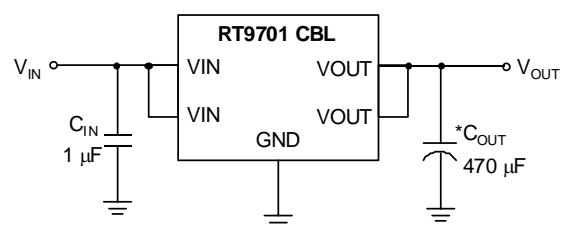

\* 470μF, Low ESR Electrolytic

## Pin Description

Pin Name	Pin Function
V <sub>IN</sub>	Power Input
V <sub>OUT</sub>	Output Voltage
GND	Ground
CE	Chip Enable

## Test Circuits

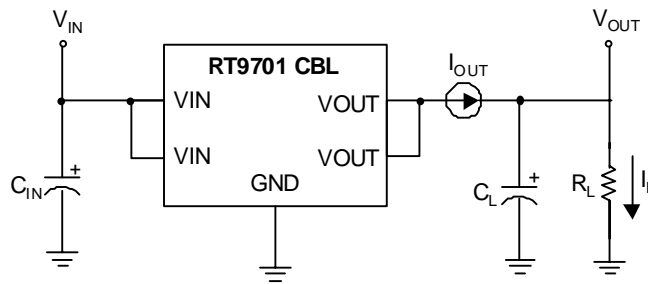

Test Circuit 1

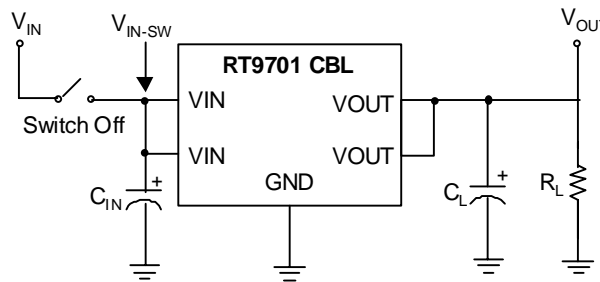

Test Circuit 2

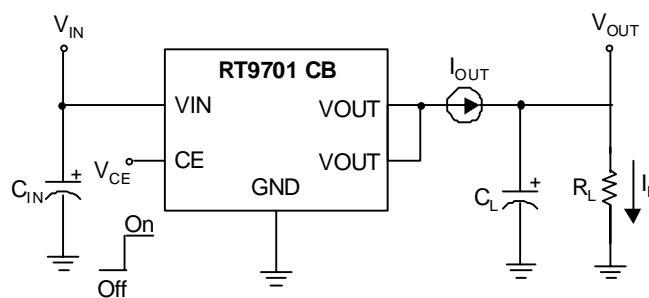

Test Circuit 3

Test Circuit 2 is performed by charging an external tank of bulk capacitor to the input then applying this voltage to the input of the unit.

All typical operating characteristics curves showed are referred to Test Circuit 1, unless specified to Test Circuit 2 or Test Circuit 3.

**Function Block Diagram**

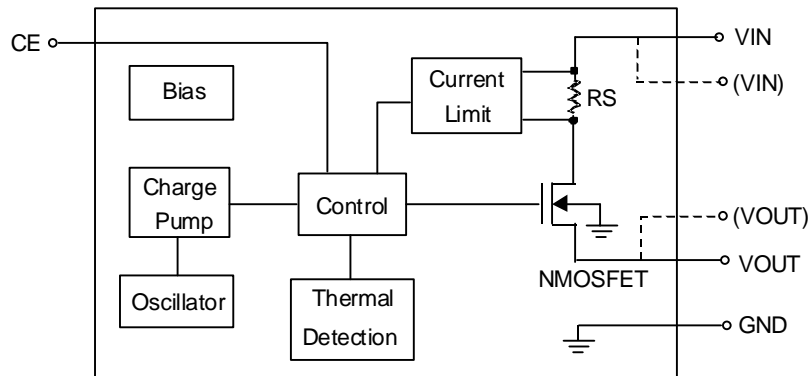

**Absolute Maximum Ratings**

- Supply Voltage ..... 7V
- Chip Enable ..... -0.3V ~ 7V
- Power Dissipation,  $P_D$  @  $T_A = 25^\circ\text{C}$
- SOT-25 ..... 0.25W
- Operating Junction Temperature Range .....  $-20^\circ\text{C} \sim 100^\circ\text{C}$
- Storage Temperature Range .....  $-65^\circ\text{C} \sim 150^\circ\text{C}$
- Package Thermal Resistance
- SOT-25,  $\theta_{JA}$  .....  $250^\circ\text{C/W}$
- $V_{OUT}$  ESD Level
- HBM (Human Body Mode) ..... 8KV
- MM (Machine Mode) ..... 800V

## Electrical Characteristics

( $V_{IN} = 5V$ ,  $C_{IN} = C_{OUT} = 1\mu F$ ,  $T_A = 25^\circ C$ , unless otherwise specified)

Parameter	Symbol	Test Conditions	Min	Typ	Max	Units	
Input Voltage Range	$V_{IN}$		2.2	--	6	V	
Output NMOFET $R_{DS(ON)}$	RT9701CBL	$I_L = 1A$	--	100	130	$m\Omega$	
	RT9701CB	$I_L = 1A$	--	105	135		
Supply Current		$V_{IN} = 3V$	--	19	40	$\mu A$	
		$V_{IN} = 5V$	--	23	45		
Output Turn-On Rising Time	$T_R$	$R_L = 10\Omega$ , 90% Settling	--	400	--	$\mu S$	
Current Limit Threshold	$I_{LIMIT}$	$R_L = 2\Omega$	1.1	1.5	2	A	
Short-circuit Fold Back Current	$I_{OS}$	$V_{OUT} = 0V$ , measured prior to thermal shutdown	--	1.0	--	A	
CE Input High Threshold	RT9701CB		2.0	--	--	V	
CE Input Low Threshold	RT9701CB		--	--	0.8	V	
Shutdown Supply Current	RT9701CB	$I_{OFF}$	$CE = "0"$	--	0.1	1	$\mu A$
Output Leakage Current	RT9701CB	$I_{LEAKAGE}$	$CE = "0"$ , $V_{OUT} = 0V$	--	0.5	10	$\mu A$
$V_{IN}$ Under Voltage Lockout	UVLO		1.3	1.8	--	V	
$V_{IN}$ Under Voltage Hysteresis			--	100	--	mV	
Thermal Limit	$T_{SD}$		--	130	--	$^\circ C$	
Thermal Limit Hysteresis	$\Delta T_{SD}$		--	20	--	$^\circ C$	

**Typical Operating Characteristics**

**Supply Current vs. Temp.**

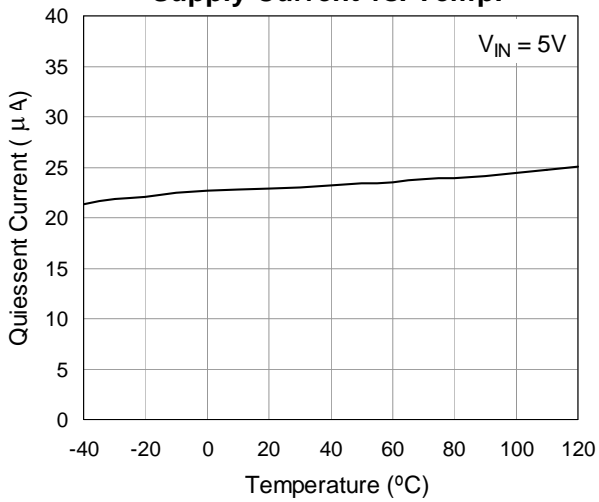

**Supply Current vs. Voltage**

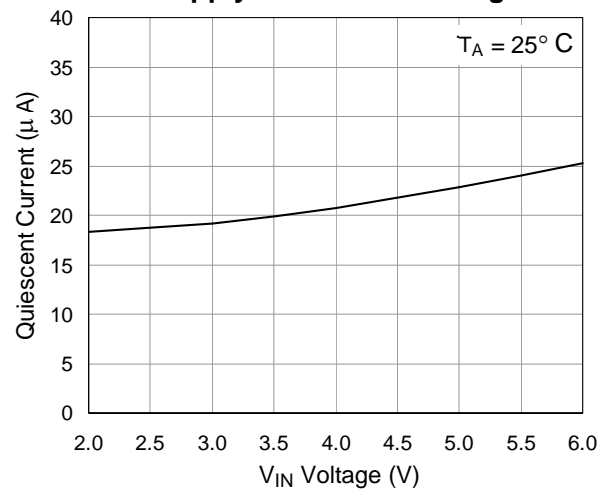

**On-Resistance vs. Temp.**

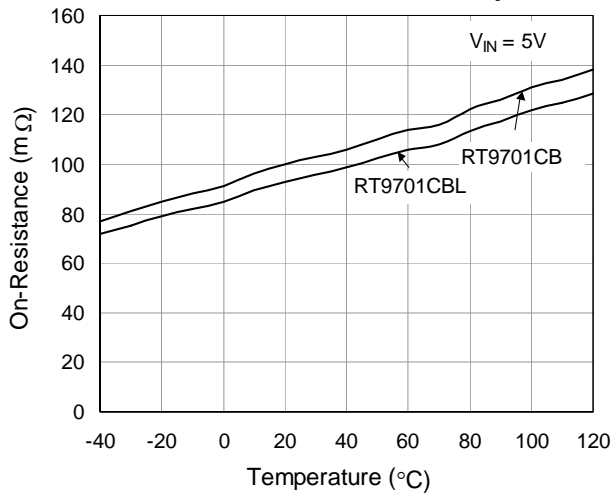

**On-Resistance vs. Voltage**

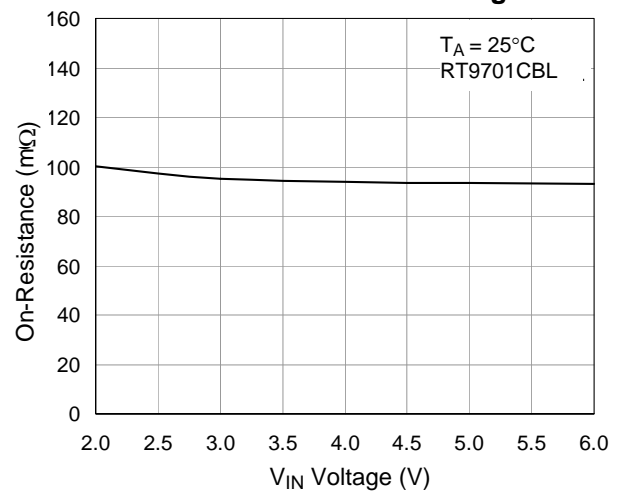

**Current Limit vs. Temp.**

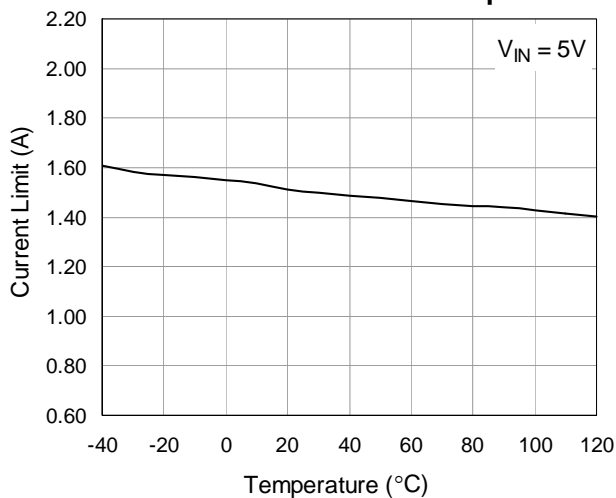

**Current Limit vs. Voltage**

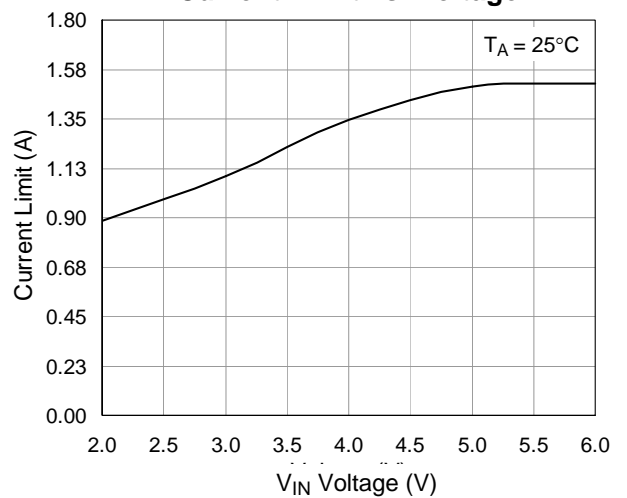

Short Circuit Current vs. Temp.

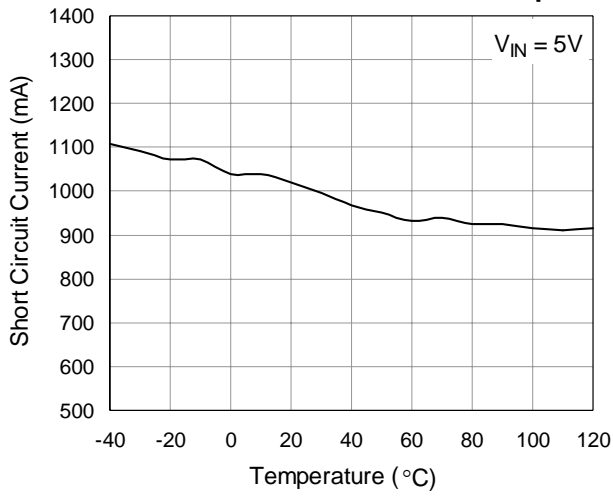

Short Circuit Current vs. Voltage

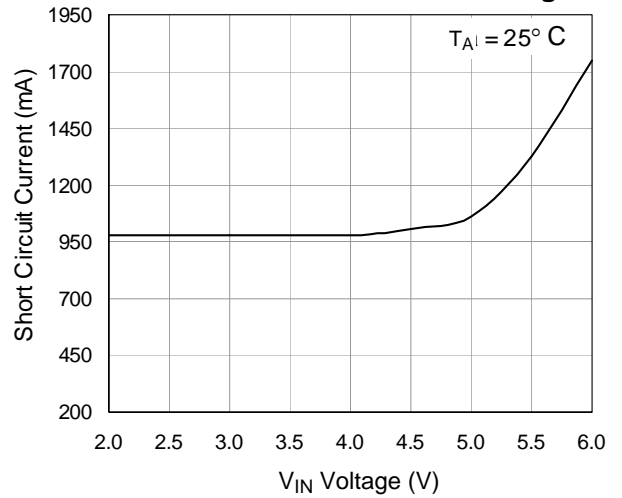

CE Threshold vs. Temp.

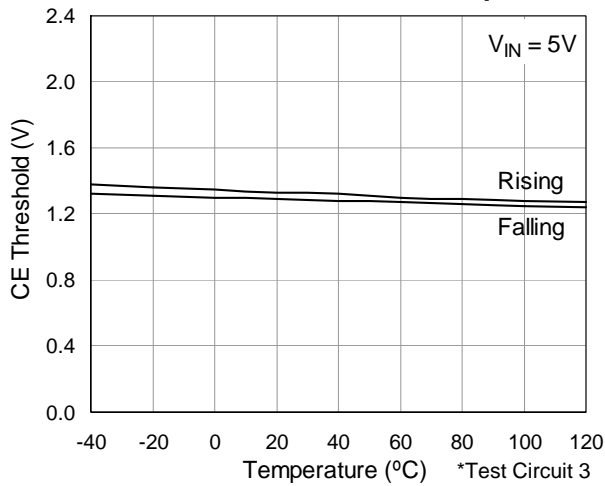

CE Threshold vs. Voltage

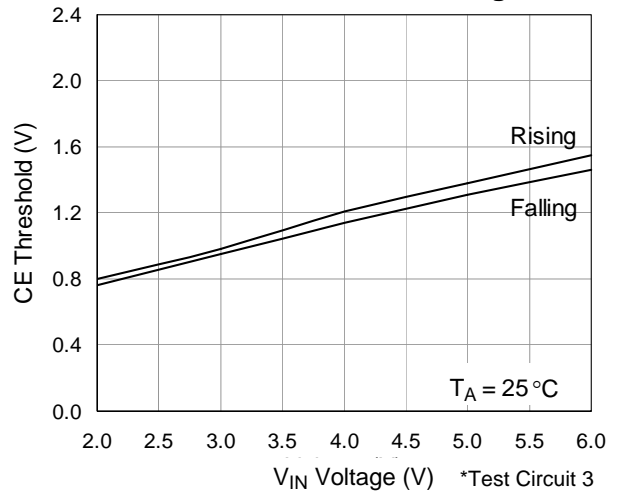

Turn On Rising Time vs. Temp.

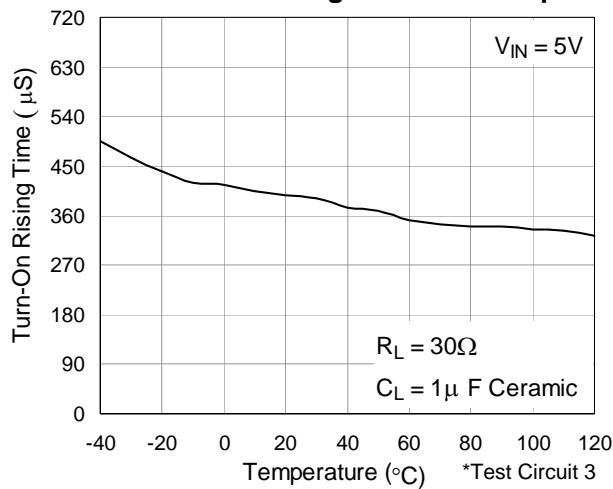

Turn Off Falling Time vs. Temp.

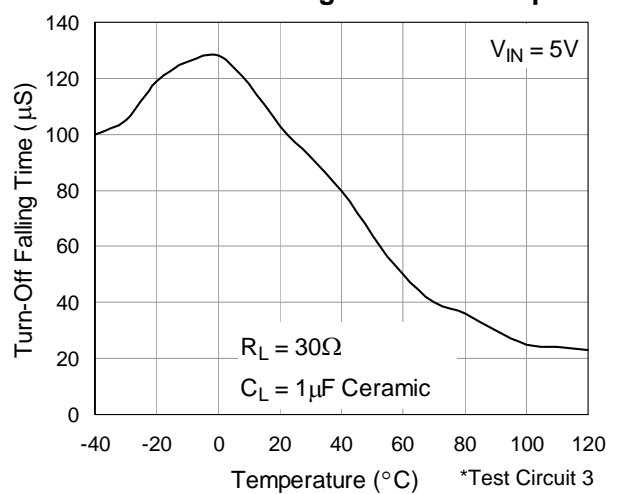

**Shutdown Supply Current vs. Temp.**

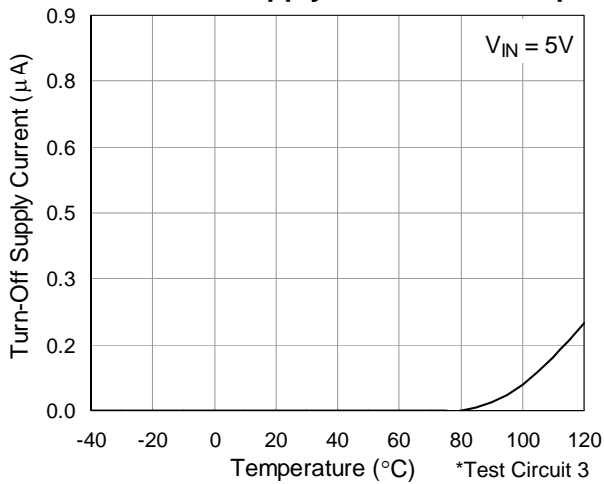

**Turn-Off Leakage Current vs. Temp.**

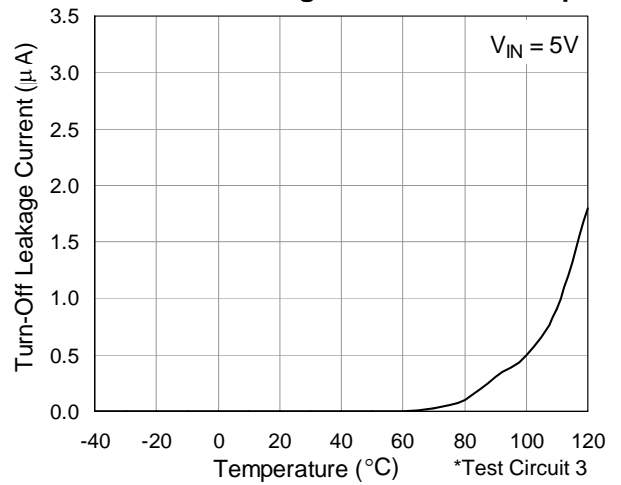

**UVLO Threshold vs. Temp.**

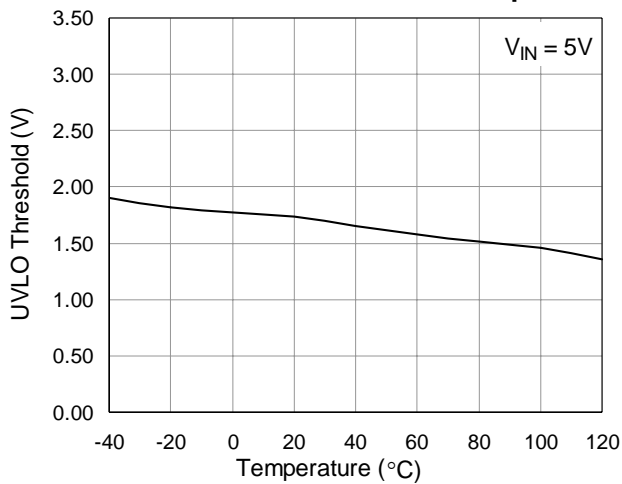

**Inrush Current Response**

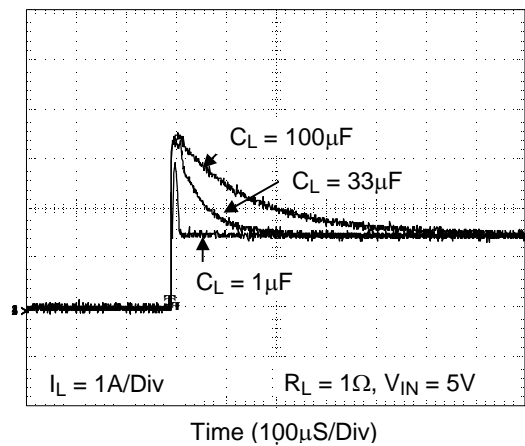

**Turn-On Response**

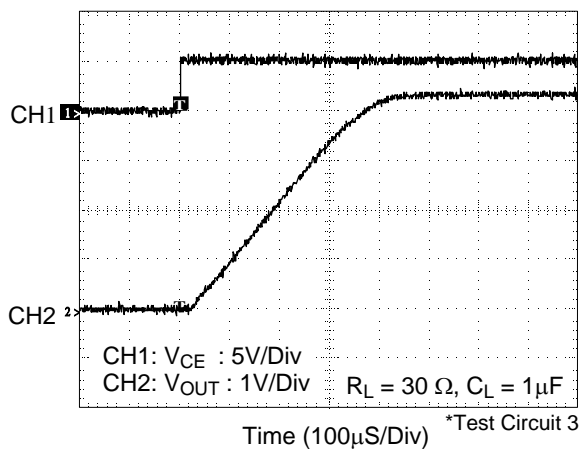

**Turn-Off Response**

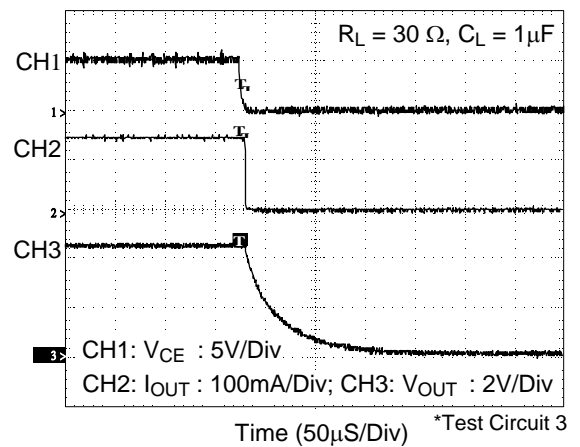

UVLO at Rising

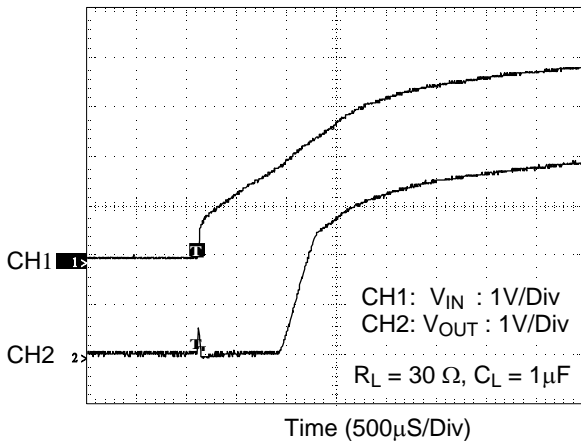

UVLO at Falling

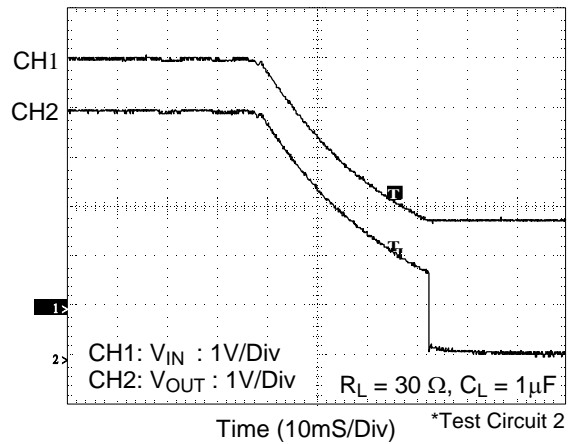

Inrush Short Circuit Response

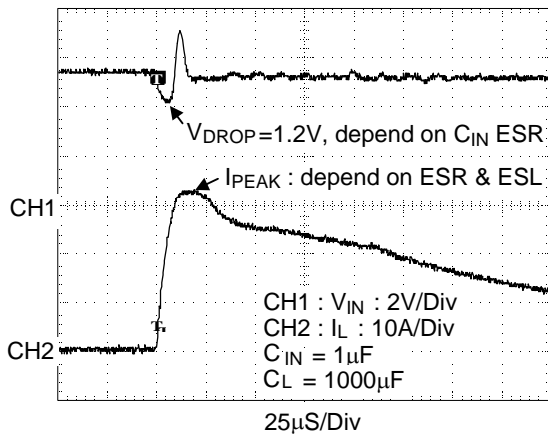

Soft-start Short Circuit Response

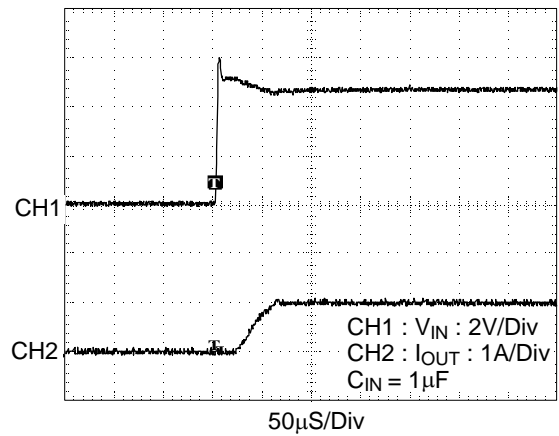

Ramped Load Response

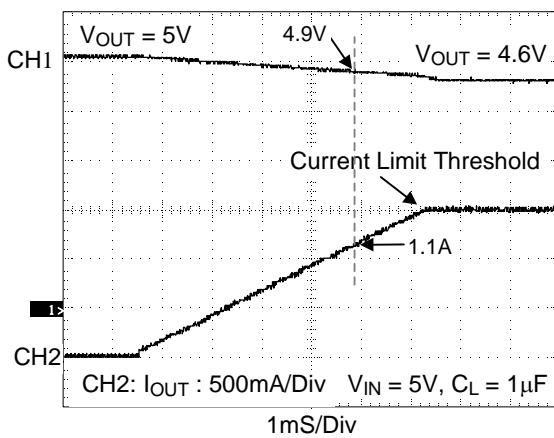

Current Limit Response

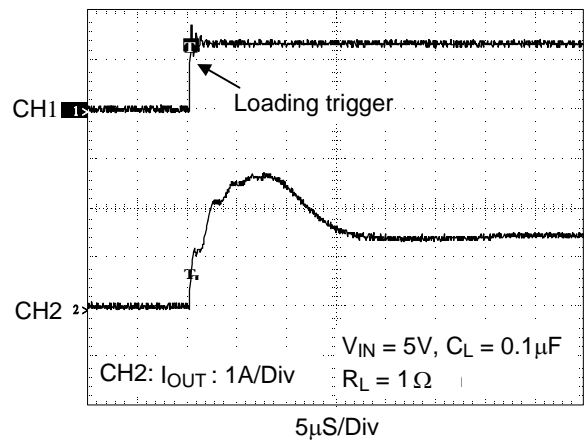



**Thermal Shut Down Response**

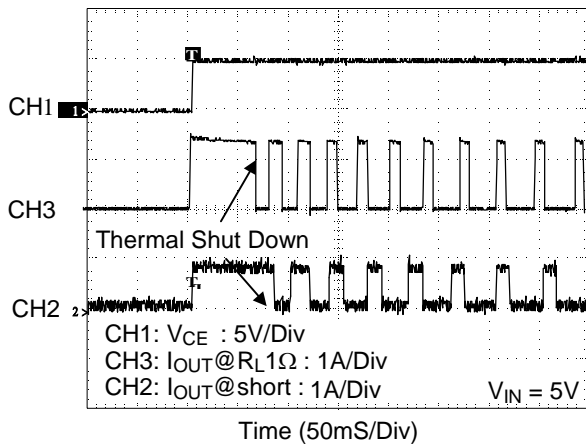

**Functional Description**

The RT9701 is a high-side single N-channel switch with active-high enable input.

**Input and Output**

V<sub>IN</sub> (input) is the power supply connection to the circuitry and the drain of the output MOSFET. V<sub>OUT</sub> (output) is the source of the output MOSFET. In a typical circuit, current flows through the switch from V<sub>IN</sub> to V<sub>OUT</sub> toward the load. Both V<sub>OUT</sub> pins must be short on the board and connected to the load and so do both V<sub>IN</sub> pins but connected to the power source.

**Thermal Shutdown**

Thermal shutdown shuts off the output MOSFET if the die temperature exceeds 130°C and 20°C of hysteresis forces the switch turning off until the die temperature drops to 110°C.

**Soft Start**

In order to eliminate the upstream voltage droop caused by the large inrush current during hot-plug events, the “soft-start” feature effectively isolates power supplies from such highly capacitive loads.

**Under-voltage Lockout**

UVLO prevents the MOSFET switch from turning on until input voltage exceeds 1.8V (typical). If input

voltage drops below 1.8V (typical), UVLO shuts off the MOSFET switch.

**Current Limiting and Short Protection**

The current limit circuit is designed to protect the system supply, the MOSFET switch and the load from damage caused by excessive currents. The current limit threshold is set internally to allow a minimum of 1.1A through the MOSFET but limits the output current to approximately 1.5A typical. When the output is short to ground, it will limit to a constant current 1A until thermal shutdown or short condition removed.

## Applications Information

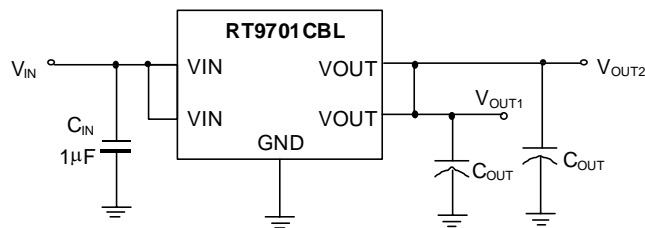

$C_{IN} = 1\mu\text{F}$ ,  $C_{OUT} = 470\mu\text{F}$  (Low ESR) on M/B  
 $C_{IN} = 1\mu\text{F}$ ,  $C_{OUT} = 330\mu\text{F}$  (Low ESR) on Notebook  
 $C_{IN} = 10\mu\text{F}$ ,  $C_{OUT} = 1\mu\text{F}$  on USB device

Fig. 1 High Side Power Switch

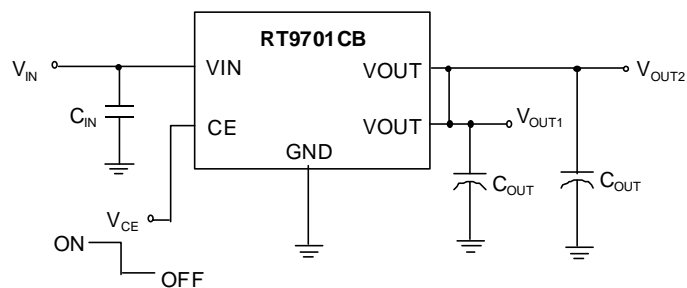

Fig. 2 High Side Power Switch with Chip Enable Control

### Filtering

To limit the input voltage drop during hot-plug events, connect a  $1\mu\text{F}$  ceramic capacitor from VIN to GND. However, higher capacitor values will further reduce the voltage drop at the input.

Connect a sufficient capacitor from VOUT to GND. This capacitor helps to prevent inductive parasitics from pulling VOUT negative during turn-off or EMI damage to other components during the hot-detachment. It is also necessary for meeting the USB specification during hot plug-in operation. If RT9701 is implanted in device end application, minimum  $1\mu\text{F}$  capacitor from VOUT to GND is recommended and higher capacitor values are also preferred.

In choosing these capacitors, special attention must be paid to the Effective Series Resistance, ESR, of the capacitors to minimize the IR drop across the capacitor's ESR. A lower ESR on this capacitor can get a lower IR drop during the operation.

Ferrite beads in series with all power and ground lines are recommended to eliminate or significantly reduce EMI. In selecting a ferrite bead, the DC resistance of the wire used must be kept to a minimum to reduce the voltage drop.

### Reverse current preventing

The output MOSFET and driver circuitry are also designed to allow the MOSFET source to be externally forced to a higher voltage than the drain ( $V_{OUT} > V_{IN} \geq 0$ ). To prevent reverse current from such condition, disable the switch (RT9701CB) or connect VIN to a fixed voltage under 1.3V.

### Layout and Thermal Dissipation

- Place the switch as close to the USB connector as possible. Keep all traces as short as possible to reduce the effect of undesirable parasitic inductance.
- Place the output capacitor and ferrite beads as close to the USB connector as possible.
- If ferrite beads are used, use wires with minimum resistance and large solder pads to minimize connection resistance.
- If the package is with dual VOUT or VIN pins, short both the same function pins as Fig.1 or Fig.2 to reduce the internal turn-on resistance. If the output power will be delivered to two individual ports, it is specially necessary to short both VOUT pin at the switch output side in order to protect the switch when each port are plug-in separately.
- Under normal operating conditions, the package can dissipate the channel heat away. Wide power-bus planes connected to VIN and VOUT and a ground plane in contact with the device will help dissipate additional heat.

**Package Information**

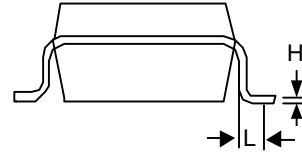
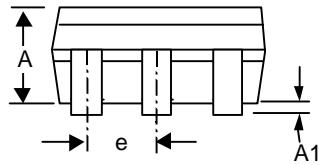
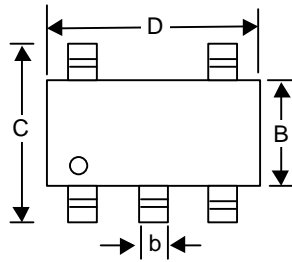

Symbol	Dimensions In Millimeters		Dimensions In Inches	
	Min	Max	Min	Max
A	0.889	1.295	0.035	0.051
A1	0.000	0.152	0.000	0.006
B	1.397	1.803	0.055	0.071
b	0.356	0.559	0.014	0.022
C	2.591	2.997	0.102	0.118
D	2.692	3.099	0.106	0.122
e	0.838	1.041	0.033	0.041
H	0.102	0.254	0.004	0.010
L	0.356	0.610	0.014	0.024

**SOT- 25 Surface Mount Package**

**RICHTEK TECHNOLOGY CORP.**

Headquarter

5F, No. 20, Taiyuen Street, Chupei City  
Hsinchu, Taiwan, R.O.C.

Tel: (8863)5526789 Fax: (8863)5526611

**RICHTEK TECHNOLOGY CORP.**

Taipei Office (Marketing)

8F-1, No. 137, Lane 235, Paochiao Road, Hsintien City  
Taipei County, Taipei, R.O.C.

Tel: (8862)89191466 Fax: (8862)89191465

Email: [marketing@richtek.com](mailto:marketing@richtek.com)