

# HIGH FLUX LED ILLUMINATORS- 12 VOLT

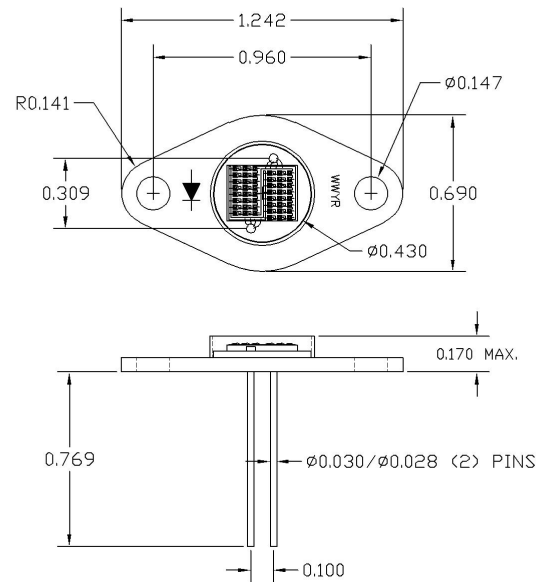
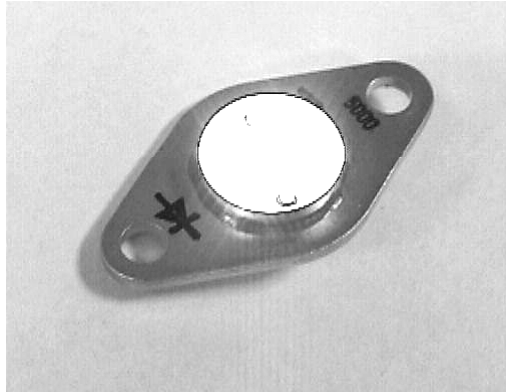

## PRODUCT DESCRIPTION

The OTLH-0090-BU, OTLH-0100-GN, and OTLH-0120-WT continue the series of high flux LED based illuminators with a reduced forward voltage version of blue (470nm), green (530nm), and white visible emissions. These parts were created to be more compatible with the forward voltages of the OTLH-0040-RD and OTLH-0030-AM red and amber devices. These LED's utilize InGaN die. The LED's are mounted on a BeO substrate which is attached to a TO-66 power package to ensure high reliability through efficient heat transfer. These illuminators are intended for use in high luminous, hard to access applications such as Aerospace Lighting, Emergency & Signal Lighting, Hazardous Lighting, Electronic Signs, and General Industrial Lighting and Illumination.

## ILLUMINATOR PART NUMBER GUIDE

PART NUMBER	COLOR	DOMINANT WAVELENGTH (TYP $\lambda_D$ , nm)	TYPICAL INITIAL STATIC LUMINOUS FLUX ( TYP $\Phi_V$ , lm, $T_J = 25^\circ\text{C}$ )
OTLH-0090-BU	BLUE	470	9.5 ( $I_F = 480\text{ mA}$ )
OTLH-0100-GN	GREEN	530	42 ( $I_F = 480\text{ mA}$ )
OTLH-0120-WT	WHITE	N/A	42 ( $I_F = 480\text{ mA}$ )

## ABSOLUTE MAXIMUM RATINGS ( $T_J = 25^\circ\text{C}$ )

Power Dissipation	Blue, Green, White (Derate 240 mW/°C above 76°C):	5 W
Static Forward Current	Blue, Green, White:	480 mA
Peak Forward Current ( Pulse Width $\leq 10\text{ ms}$ and Duty Cycle $\leq 10\%$ )	Blue, Green, White:	3.2 A
Reverse Leakage ( $V_r = 15\text{ Volts}$ )	TBD	
Lead Soldering Temperature	$\leq 240^\circ\text{C}$ for $\leq 10\text{ seconds}$	

# HIGH FLUX LED ILLUMINATORS- 12 VOLT

## INITIAL ELECTRO-OPTICAL CHARACTERISTICS at $T_J = 25^\circ\text{C}$ , $I_F = 320\text{ mA}$

TYPE	LUMINOUS FLUX ( $\Phi_V$ , lm)		RADIANT FLUX (Factor, $P_e$ , $\mu\text{W}$ ) (Calculated)		FORWARD VOLTAGE ( $V_F$ , V)		DOMINANT WAVELENGTH [PEAK] WAVELENGTH ( $\lambda_D$ [ $\lambda_P$ ], nm)			FULL WIDTH HALF MAXIMUM ( $\Delta\lambda$ , nm)
	MIN	TYP	Factor	TYP	TYP	MAX	MIN	TYP	MAX	TYP
BLUE		7.0	51.5 lm/W @ 465nm		10.2		465	470 / [466] x = 0.13 y = 0.07	475	35
GREEN		34.0	588 lm/W @ 530nm		9.6		520	530 / [525] x = 0.19 y = 0.70	540	45
WHITE		34.0	-----	-----	10.1			x = 0.32 y = 0.33		N/A

## OPTICAL CHARACTERISTICS

Viewing Angle ( $\pm \theta_{1/2}$ )	$\pm 54$ degrees typical
Total Beam Width	$\pm 78$ degrees typical

## THERMAL PARAMETERS

Operating Temperature	-40 °C to +100 °C
Maximum Junction Temperature	Green, Blue White: 100 °C
Typical Junction to Still Air Thermal Resistance, $R_{THJA}$	65 °C/W
Typical Junction to Case Thermal Resistance, $R_{THJC}$	Blue, Green, White: 4.0 °C/W

## ELECTRICAL PARAMETERS (Typical)

Parameter	Conditions	Green	Blue / White
Capacitance, Junction $C_{j0}$	$V_d = 0$ volts	147 pF	372 pF
Capacitance, Case to Pin	--	8 pF	9 pF
Rise Time, Electrical	$R_{source} = 30$ ohm, $I_f = 320$ mA	7 nSec	11 nSec
Fall Time, Electrical	$R_{source} = 30$ ohm, $I_f = 320$ mA	15 nSec	30 nSec

# HIGH FLUX LED ILLUMINATORS- 12 VOLT

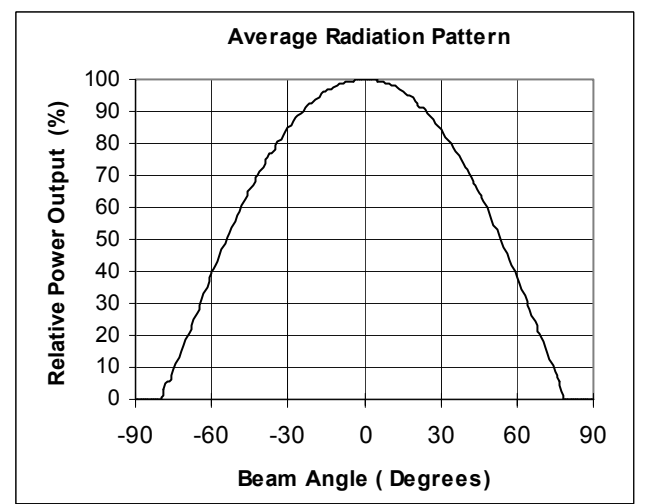
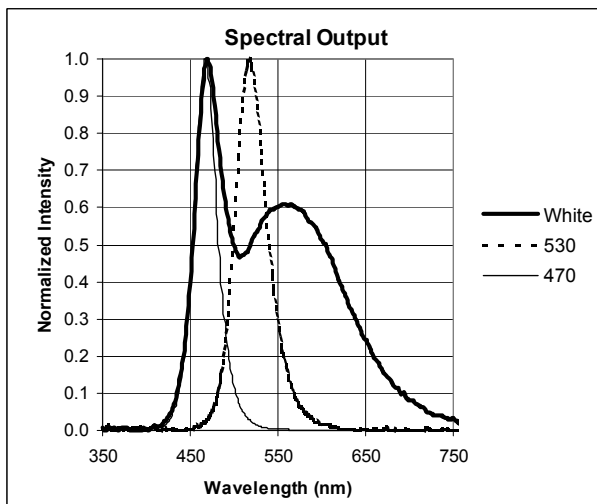
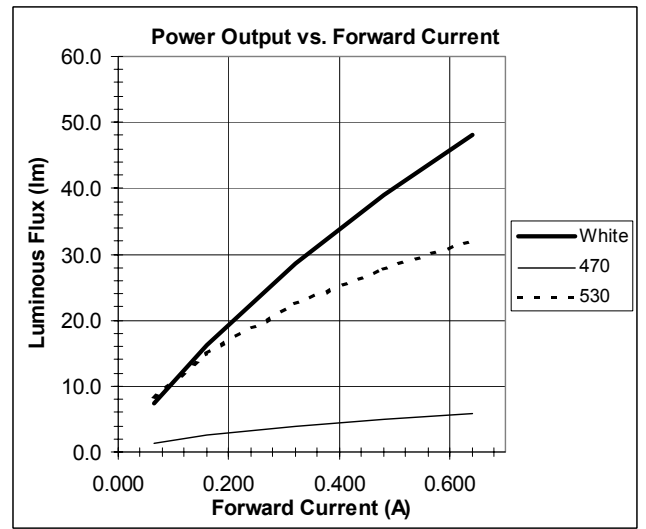
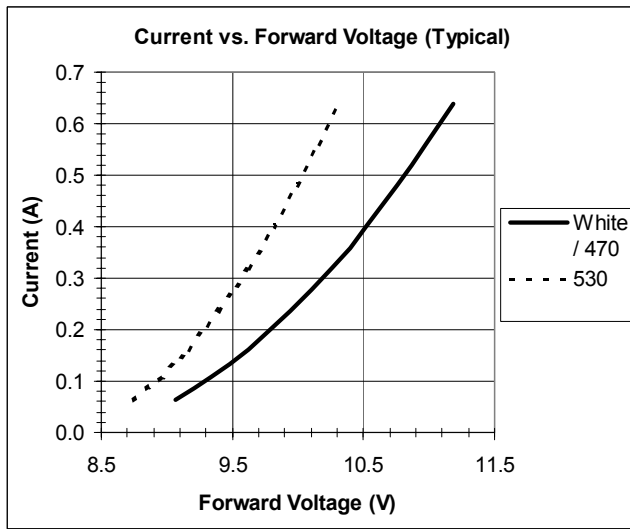
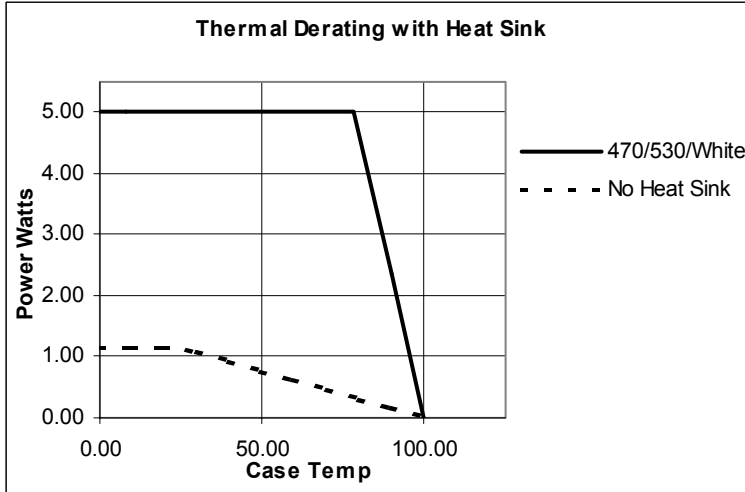

# HIGH FLUX LED ILLUMINATORS- 12 VOLT

---

## EYE SAFETY ISSUES

Currently, the LED industry has no universally agreed upon standard to cover eye safety issues associated with the use of LED products. The closest is CEI/IEC 60825-1, used in Europe, which was originally developed for lasers. It was later amended to include LED's, but some in the industry have reservations as to the applicability of this standard to LED's. Under this standard, the OTLH-0090-BU (470nm) and OTLH-0100-GN (530nm) are class 2 LED products and carry the warning:



**LED RADIATION**  
**DO NOT STARE INTO BEAM (for 470nm and 530nm Sharks)**  
**CLASS 2 LED PRODUCT**

## Handling and Other Precautions

These parts are high power devices and as such are intended to be used with a heatsink. Devices operated without proper heat sink conditions, or proper current limiting will reach hazardous temperatures very quickly. Do not operate devices under these conditions under any circumstances.

These parts contain a Beryllia ceramic substrate. Beryllia ceramic, in solid form and as contained in finished products presents no special health risks. **Warning:** Overexposure to beryllium by inhalation may cause chronic beryllium disease, a chronic lung disease, and cancer. Therefore; processing or recycling using (for example) grinding, melting, welding, or sawing, of this device or as contained in a final assembly may produce airborne dust, fumes, or mists and therefore the use of exhaust ventilation or other controls should be used to prevent exposure to workers.

## Electro-Static-Discharge

Any semiconductor circuit can be damaged by ESD. OPTO TECHNOLOGY INC. recommends that all LED circuits be handled with appropriate precautions. Failure to observe proper handling and installation procedures can cause damage to the component. ESD damage can range from subtle performance degradation to complete device failure.

## Silicone Overcoat

The Shark series components have a silicone overcoat, which is soft and flexible (40 durometer, Shore A) and should not be immersed or cleaned with water, alcohol, or other chemical solvents or agents. The overcoat material should not be removed, scraped, touched, pressed, or pulled to avoid stress damage and possible breakage of delicate wire bonds.

Surface dust can be carefully removed with a soft brush, or canned air such as those used for cleaning photographic lenses.

The silicone overcoat material has a flammability classification of 94 V-1 and a temperature rating of 130° C.

## Mechanical Stress

This component is not suitable for SMT / solder reflow operations. Refrain from twisting leads or unconstrained crimp or lead cut forces, which could break the glass seals of the leads and break internal wire bonds.

## Life Support

**OPTO TECHNOLOGY PRODUCTS ARE NOT AUTHORIZED FOR USE AS CRITICAL COMPONENTS IN LIFE SUPPORT DEVICES OR SYSTEMS WITHOUT THE EXPRESS WRITTEN APPROVAL OF THE PRESIDENT OF OPTO TECHNOLOGY INC.** As used herein:

- a. Life support devices or systems are devices or systems which (1) are intended for surgical implant into the body, or (2) support or sustain life and whose failure to perform when properly used in accordance with instructions for use provided in the labeling, can be reasonably expected to result in a significant injury to the user.
- b. A critical component is any component of a life support device or system whose failure to perform can be reasonably be expected to cause the failure of the life support device or system, or to affect its safety or effectiveness.

The information provided herein is believed to be reliable, however OPTO TECHNOLOGY INC. assumes no responsibility for inaccuracies or omissions.

OPTO TECHNOLOGY INC. reserves the right to make changes at any time without notice to any products to improve reliability, function or design or to circuitry or specifications. OPTO TECHNOLOGY INC. does not assume any liability arising out of the application or use of any product or circuit described herein, neither does it convey any license under its patent rights, nor the rights of others.