

LM2931 Series

100 mA, Adjustable Output, LDO Voltage Regulator with 60 V Load Dump Protection

The LM2931 series consists of positive fixed and adjustable output voltage regulators that are specifically designed to maintain proper regulation with an extremely low input-to-output voltage differential. These devices are capable of supplying output currents in excess of 100 mA and feature a low bias current of 0.4 mA at 10 mA output.

Designed primarily to survive in the harsh automotive environment, these devices will protect all external load circuitry from input fault conditions caused by reverse battery connection, two battery jump starts, and excessive line transients during load dump. This series also includes internal current limiting, thermal shutdown, and additionally, is able to withstand temporary power-up with mirror-image insertion.

Due to the low dropout voltage and bias current specifications, the LM2931 series is ideally suited for battery powered industrial and consumer equipment where an extension of useful battery life is desirable. The 'C' suffix adjustable output regulators feature an output inhibit pin which is extremely useful in microprocessor-based systems.

- Input-to-Output Voltage Differential of $< 0.6\text{ V}$ @ 100 mA
- Output Current in Excess of 100 mA
- Low Bias Current
- 60 V Load Dump Protection
- -50 V Reverse Transient Protection
- Internal Current Limiting with Thermal Shutdown
- Temporary Mirror-Image Protection
- Ideally Suited for Battery Powered Equipment
- Economical 5-Lead TO-220 Package with Two Optional Leadforms
- Available in Surface Mount SOP-8, D²PAK and DPAK Packages
- High Accuracy ($\pm 2\%$) Reference (LM2931AC) Available

SOIC-8
D SUFFIX
CASE 751

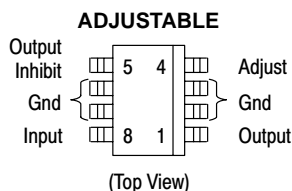
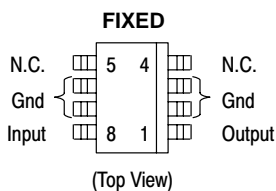

ON Semiconductor®

<http://onsemi.com>

FIXED OUTPUT VOLTAGE

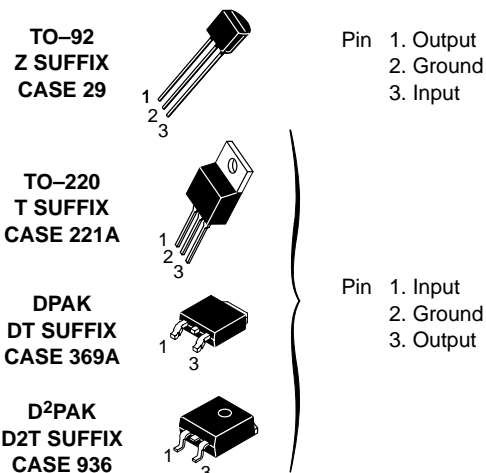

ADJUSTABLE OUTPUT VOLTAGE

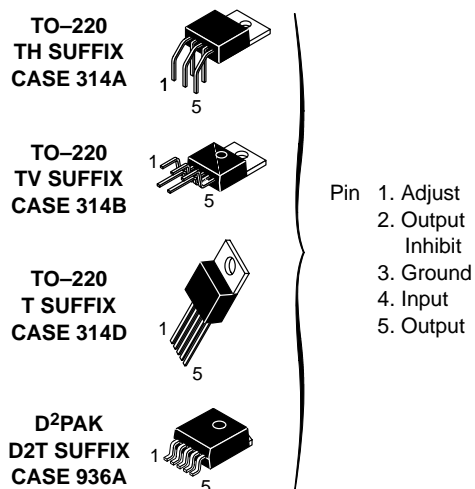

ORDERING INFORMATION

See detailed ordering and shipping information in the package dimensions section on page 12 of this data sheet.

DEVICE MARKING INFORMATION

See general marking and heatsink information in the device marking section on page 13 of this data sheet.

LM2931 Series

Representative Schematic Diagram

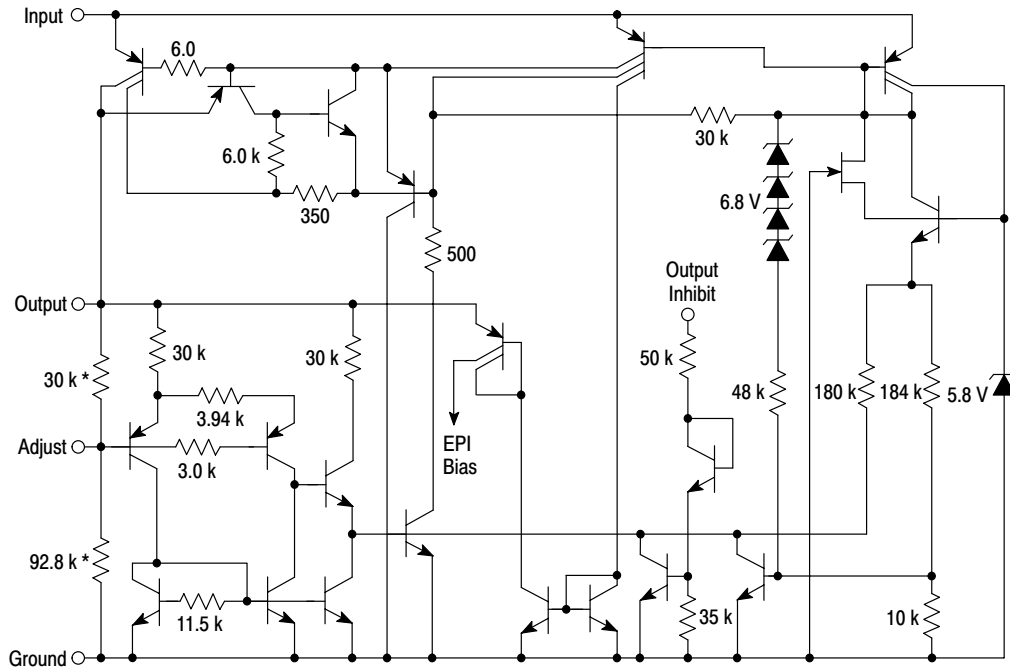

*Deleted on Adjustable Regulators

This device contains 26 active transistors.

LM2931 Series

MAXIMUM RATINGS

Rating	Symbol	Value	Unit
Input Voltage Continuous	V_I	40	Vdc
Transient Input Voltage ($\tau \leq 100$ ms)	$V_I(\tau)$	60	Vpk
Transient Reverse Polarity Input Voltage 1.0% Duty Cycle, $\tau \leq 100$ ms	$-V_I(\tau)$	-50	Vpk
Power Dissipation			
Case 29 (TO-92 Type)			
$T_A = 25^\circ\text{C}$	P_D	Internally Limited	W
Thermal Resistance, Junction-to-Ambient	$R_{\theta JA}$	178	$^\circ\text{C/W}$
Thermal Resistance, Junction-to-Case	$R_{\theta JC}$	83	$^\circ\text{C/W}$
Case 221A, 314A, 314B and 314D (TO-220 Type)			
$T_A = 25^\circ\text{C}$	P_D	Internally Limited	W
Thermal Resistance, Junction-to-Ambient	$R_{\theta JA}$	65	$^\circ\text{C/W}$
Thermal Resistance, Junction-to-Case	$R_{\theta JC}$	5.0	$^\circ\text{C/W}$
Case 369A (DPAK) (Note 1)			
$T_A = 25^\circ\text{C}$	P_D	Internally Limited	W
Thermal Resistance, Junction-to-Ambient	$R_{\theta JA}$	92	$^\circ\text{C/W}$
Thermal Resistance, Junction-to-Case	$R_{\theta JC}$	6.0	$^\circ\text{C/W}$
Case 751 (SOP-8) (Note 2)			
$T_A = 25^\circ\text{C}$	P_D	Internally Limited	W
Thermal Resistance, Junction-to-Ambient	$R_{\theta JA}$	160	$^\circ\text{C/W}$
Thermal Resistance, Junction-to-Case	$R_{\theta JC}$	25	$^\circ\text{C/W}$
Case 936 and 936A (D ² PAK) (Note 3)			
$T_A = 25^\circ\text{C}$	P_D	Internally Limited	W
Thermal Resistance, Junction-to-Ambient	$R_{\theta JA}$	70	$^\circ\text{C/W}$
Thermal Resistance, Junction-to-Case	$R_{\theta JC}$	5.0	$^\circ\text{C/W}$
Tested Operating Junction Temperature Range	T_J	-40 to +125	$^\circ\text{C}$
Storage Temperature Range	T_{stg}	-65 to +150	$^\circ\text{C}$

1. DPAK Junction-to-Ambient Thermal Resistance is for vertical mounting. Refer to Figure 24 for board mounted Thermal Resistance.
2. SOP-8 Junction-to-Ambient Thermal Resistance is for minimum recommended pad size. Refer to Figure 23 for Thermal Resistance variation versus pad size.
3. D²PAK Junction-to-Ambient Thermal Resistance is for vertical mounting. Refer to Figure 25 for board mounted Thermal Resistance.
4. ESD data available upon request.

LM2931 Series

ELECTRICAL CHARACTERISTICS ($V_{in} = 14\text{ V}$, $I_O = 10\text{ mA}$, $C_O = 100\text{ }\mu\text{F}$, $C_{O(ESR)} = 0.3\text{ }\Omega$, $T_J = 25^\circ\text{C}$ [Note 5])

Characteristic	Symbol	LM2931-5.0			LM2931A-5.0			Unit
		Min	Typ	Max	Min	Typ	Max	
Output Voltage $V_{in} = 14\text{ V}$, $I_O = 10\text{ mA}$, $T_J = 25^\circ\text{C}$ $V_{in} = 6.0\text{ V to }26\text{ V}$, $I_O \leq 100\text{ mA}$, $T_J = -40^\circ\text{ to }+125^\circ\text{C}$	V_O	4.75 4.50	5.0 –	5.25 5.50	4.81 4.75	5.0 –	5.19 5.25	V
Line Regulation $V_{in} = 9.0\text{ V to }16\text{ V}$ $V_{in} = 6.0\text{ V to }26\text{ V}$	Reg_{line}	– –	2.0 4.0	10 30	– –	2.0 4.0	10 30	mV
Load Regulation ($I_O = 5.0\text{ mA to }100\text{ mA}$)	Reg_{load}	–	14	50	–	14	50	mV
Output Impedance $I_O = 10\text{ mA}$, $\Delta I_O = 1.0\text{ mA}$, $f = 100\text{ Hz to }10\text{ kHz}$	Z_O	–	200	–	–	200	–	$\text{m}\Omega$
Bias Current $V_{in} = 14\text{ V}$, $I_O = 100\text{ mA}$, $T_J = 25^\circ\text{C}$ $V_{in} = 6.0\text{ V to }26\text{ V}$, $I_O = 10\text{ mA}$, $T_J = -40^\circ\text{ to }+125^\circ\text{C}$	I_B	– –	5.8 0.4	30 1.0	– –	5.8 0.4	30 1.0	mA
Output Noise Voltage ($f = 10\text{ Hz to }100\text{ kHz}$)	V_n	–	700	–	–	700	–	μV_{rms}
Long Term Stability	S	–	20	–	–	20	–	mV/kHR
Ripple Rejection ($f = 120\text{ Hz}$)	RR	60	90	–	60	90	–	dB
Dropout Voltage $I_O = 10\text{ mA}$ $I_O = 100\text{ mA}$	$V_I - V_O$	– –	0.015 0.16	0.2 0.6	– –	0.015 0.16	0.2 0.6	V
Over-Voltage Shutdown Threshold	$V_{\text{th(OV)}}$	26	29.5	40	26	29.5	40	V
Output Voltage with Reverse Polarity Input ($V_{in} = -15\text{ V}$)	$-V_O$	-0.3	0	–	-0.3	0	–	V

5. Low duty cycle pulse techniques are used during test to maintain junction temperature as close to ambient as possible.

LM2931 Series

ELECTRICAL CHARACTERISTICS ($V_{in} = 14\text{ V}$, $I_O = 10\text{ mA}$, $C_O = 100\text{ }\mu\text{F}$, $C_{O(ESR)} = 0.3\text{ }\Omega$, $T_J = 25^\circ\text{C}$ [Note 6])

Characteristic	Symbol	LM2931C			LM2931AC			Unit
		Min	Typ	Max	Min	Typ	Typ	
ADJUSTABLE OUTPUT								
Reference Voltage (Note 7, Figure 18) $I_O = 10\text{ mA}$, $T_J = 25^\circ\text{C}$ $I_O \leq 100\text{ mA}$, $T_J = -40\text{ to }+125^\circ\text{C}$	V_{ref}	1.14 1.08	1.20 –	1.26 1.32	1.17 1.15	1.20 –	1.23 1.25	V
Output Voltage Range	$V_O\text{ range}$	3.0 to 24	2.7 to 29.5	–	3.0 to 24	2.7 to 29.5	–	V
Line Regulation ($V_{in} = V_O + 0.6\text{ V to }26\text{ V}$)	Reg_{line}	–	0.2	1.5	–	0.2	1.5	mV/V
Load Regulation ($I_O = 5.0\text{ mA to }100\text{ mA}$)	Reg_{load}	–	0.3	1.0	–	0.3	1.0	%/V
Output Impedance $I_O = 10\text{ mA}$, $\Delta I_O = 1.0\text{ mA}$, $f = 10\text{ Hz to }10\text{ kHz}$	Z_O	–	40	–	–	40	–	$\text{m}\Omega/\text{V}$
Bias Current $I_O = 100\text{ mA}$ $I_O = 10\text{ mA}$ Output Inhibited ($V_{th(OI)} = 2.5\text{ V}$)	I_B	– – –	6.0 0.4 0.2	– 1.0 1.0	– – –	6.0 0.4 0.2	– 1.0 1.0	mA
Adjustment Pin Current	I_{Adj}	–	0.2	–	–	0.2	–	μA
Output Noise Voltage ($f = 10\text{ Hz to }100\text{ kHz}$)	V_n	–	140	–	–	140	–	$\mu\text{V}_{rms}/\text{V}$
Long-Term Stability	S	–	0.4	–	–	0.4	–	%/kHR
Ripple Rejection ($f = 120\text{ Hz}$)	RR	0.10	0.003	–	0.10	0.003	–	%/V
Dropout Voltage $I_O = 10\text{ mA}$ $I_O = 100\text{ mA}$	$V_I - V_O$	– –	0.015 0.16	0.2 0.6	– –	0.015 0.16	0.2 0.6	V
Over-Voltage Shutdown Threshold	$V_{th(OV)}$	26	29.5	40	26	29.5	40	V
Output Voltage with Reverse Polarity Input ($V_{in} = -15\text{ V}$)	$-V_O$	-0.3	0	–	-0.3	0	–	V
Output Inhibit Threshold Voltages Output "On": $T_J = 25^\circ\text{C}$ $T_J = -40^\circ\text{ to }+125^\circ\text{C}$ Output "Off": $T_J = 25^\circ\text{C}$ $T_J = -40^\circ\text{ to }+125^\circ\text{C}$	$V_{th(OI)}$	– – 2.50 3.25	2.15 – 2.26 –	1.90 1.20 – –	– – 2.50 3.25	2.15 – 2.26 –	1.90 1.20 – –	V
Output Inhibit Threshold Current ($V_{th(OI)} = 2.5\text{ V}$)	$I_{th(OI)}$	–	30	50	–	30	50	μA

6. Low duty cycle pulse techniques are used during test to maintain junction temperature as close to ambient as possible.

7. The reference voltage on the adjustable device is measured from the output to the adjust pin across R_1 .

LM2931 Series

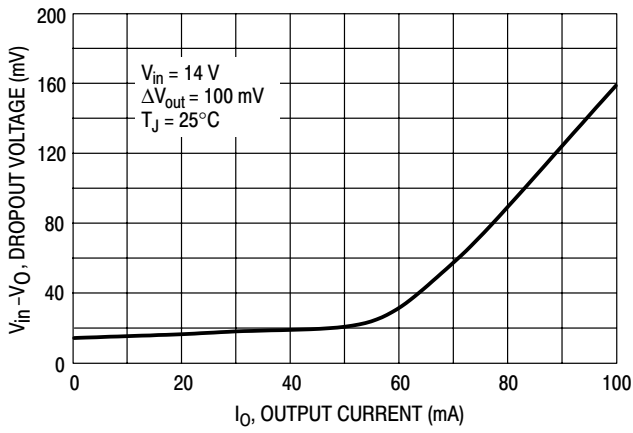

Figure 1. Dropout Voltage versus Output Current

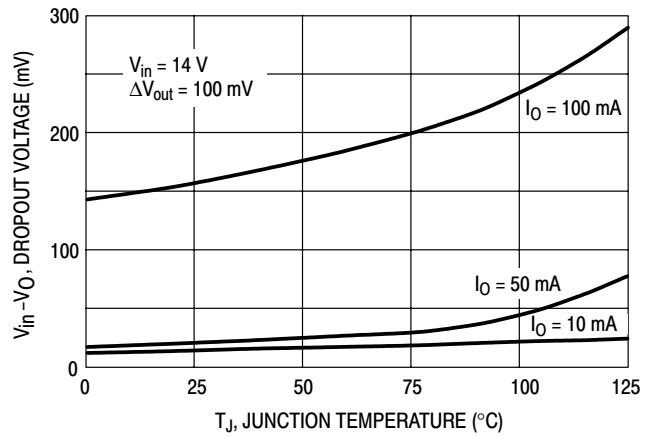

Figure 2. Dropout Voltage versus Junction Temperature

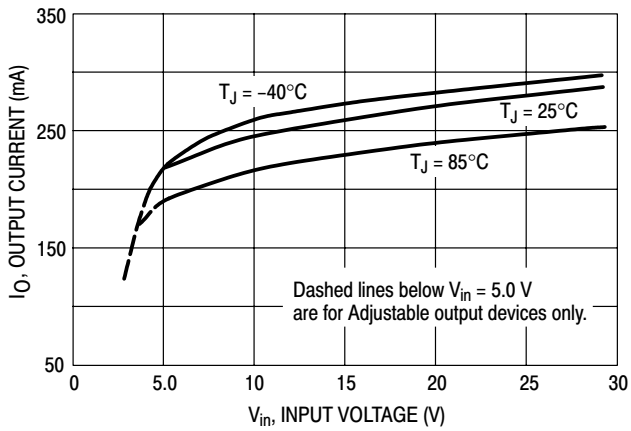

Figure 3. Peak Output Current versus Input Voltage

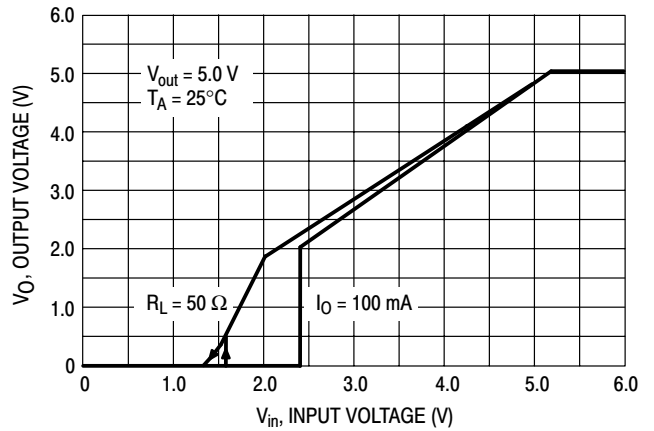

Figure 4. Output Voltage versus Input Voltage

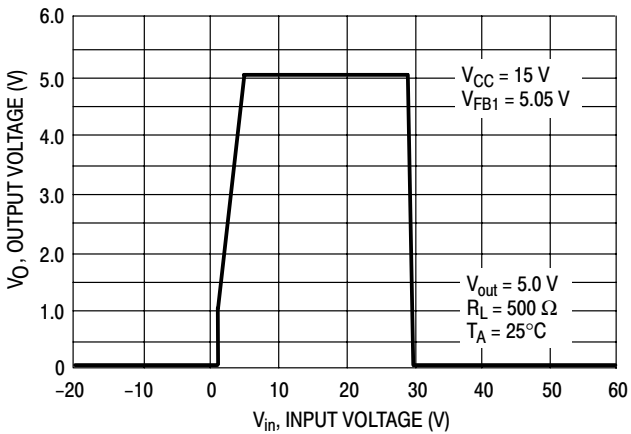

Figure 5. Output Voltage versus Input Voltage

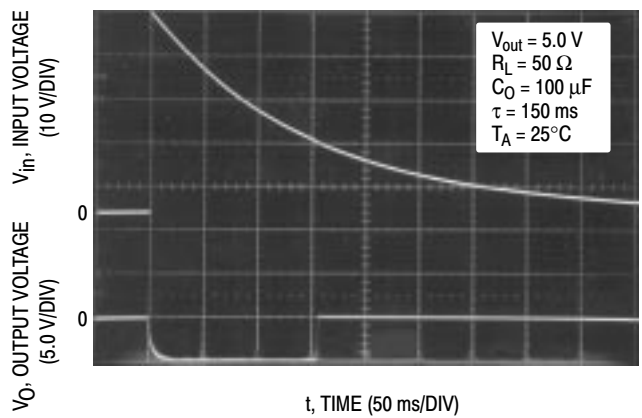

Figure 6. Load Dump Characteristics

LM2931 Series

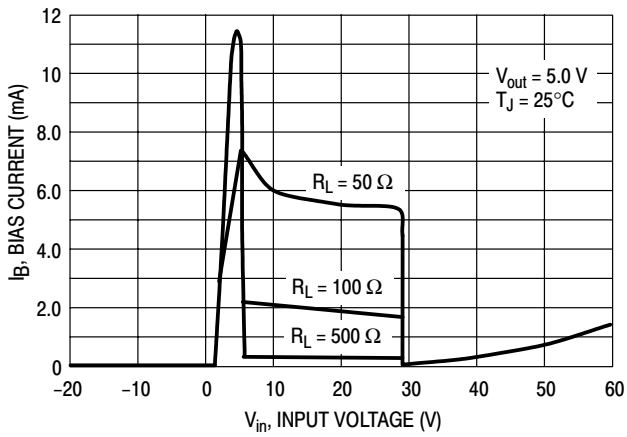

Figure 7. Bias Current versus Input Voltage

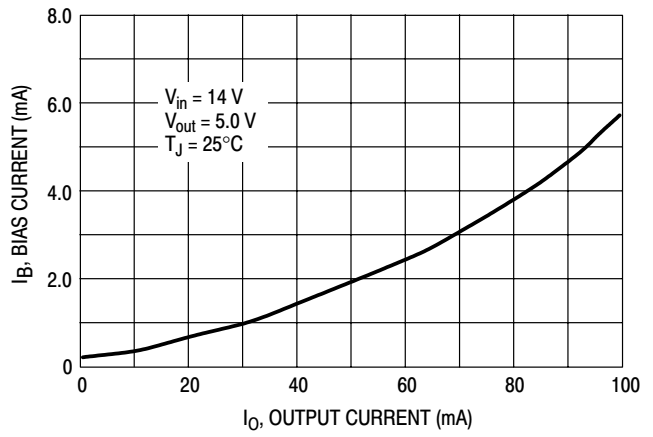

Figure 8. Bias Current versus Output Current

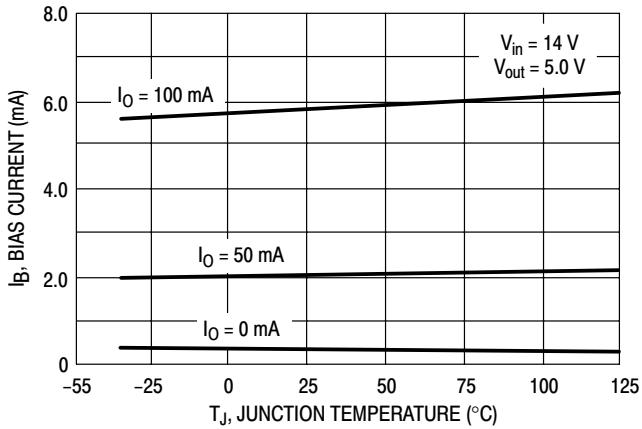

Figure 9. Bias Current versus Junction Temperature

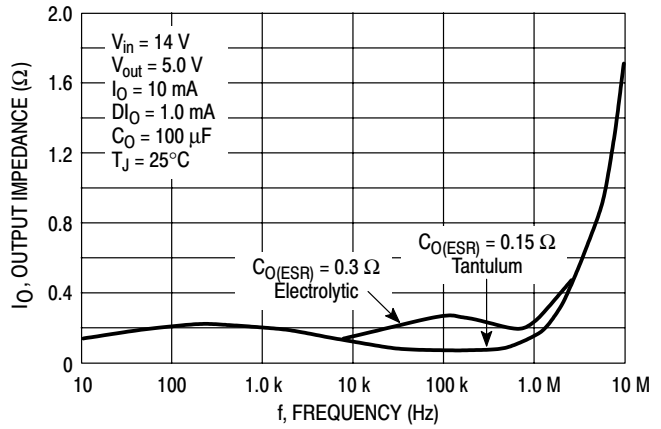

Figure 10. Output Impedance versus Frequency

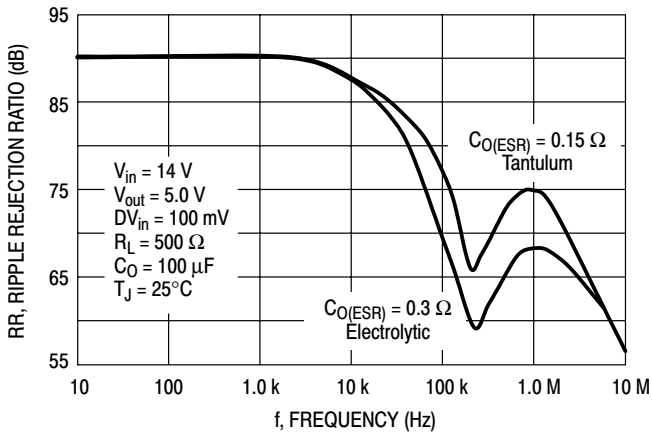

Figure 11. Ripple Rejection versus Frequency

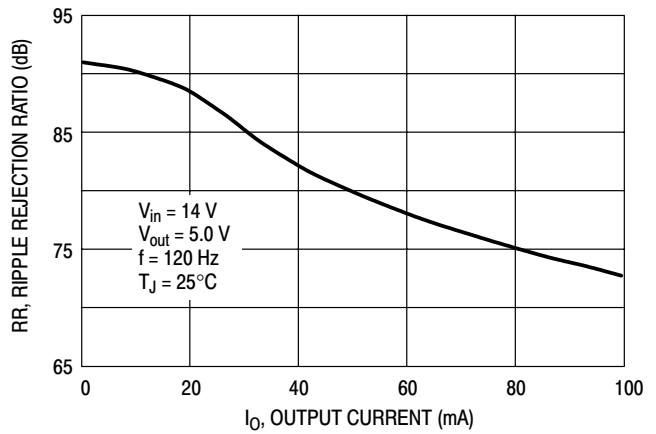

Figure 12. Ripple Rejection versus Output Current

LM2931 Series

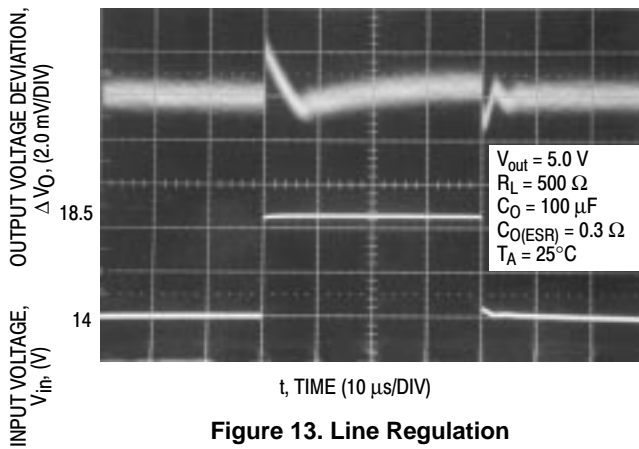

Figure 13. Line Regulation

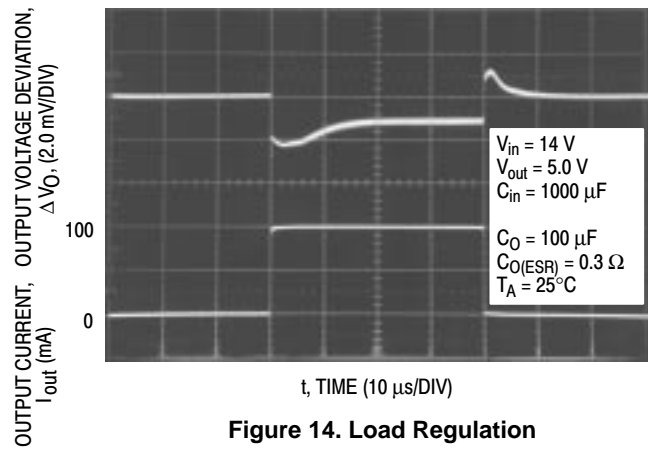

Figure 14. Load Regulation

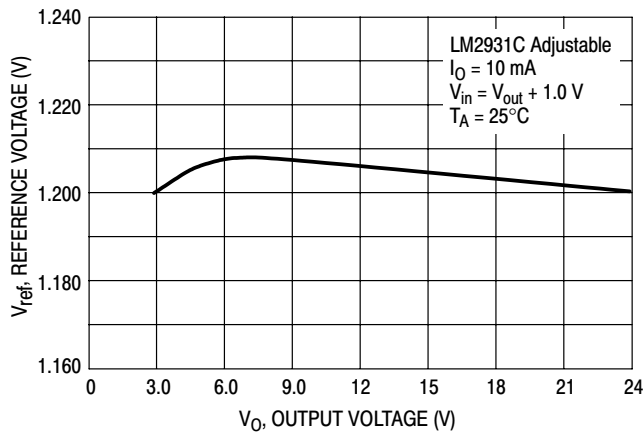

Figure 15. Reference Voltage versus Output Voltage

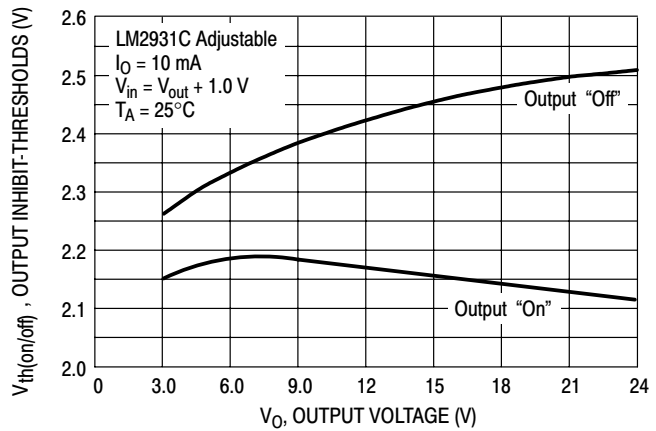

Figure 16. Output Inhibit-Thresholds versus Output Voltage

APPLICATIONS INFORMATION

The LM2931 series regulators are designed with many protection features making them essentially blow-out proof. These features include internal current limiting, thermal shutdown, overvoltage and reverse polarity input protection, and the capability to withstand temporary power-up with mirror-image insertion. Typical application circuits for the fixed and adjustable output device are shown in Figures 17 and 18.

The input bypass capacitor C_{in} is recommended if the regulator is located an appreciable distance ($\geq 4''$) from the supply input filter. This will reduce the circuit's sensitivity to the input line impedance at high frequencies.

This regulator series is not internally compensated and thus requires an external output capacitor for stability. The capacitance value required is dependent upon the load current, output voltage for the adjustable regulator, and the type of capacitor selected. The least stable condition is encountered at maximum load current and minimum output voltage. Figure 22 shows that for operation in the "Stable" region, under the conditions specified, the magnitude of the output capacitor impedance $|Z_O|$ must not exceed 0.4Ω . This

limit must be observed over the entire operating temperature range of the regulator circuit.

With economical electrolytic capacitors, cold temperature operation can pose a serious stability problem. As the electrolyte freezes, around -30°C , the capacitance will decrease and the equivalent series resistance (ESR) will increase drastically, causing the circuit to oscillate. Quality electrolytic capacitors with extended temperature ranges of -40° to $+85^\circ\text{C}$ and -55° to $+105^\circ\text{C}$ are readily available. Solid tantalum capacitors may be a better choice if small size is a requirement, however, the maximum $|Z_O|$ limit over temperature must be observed.

Note that in the stable region, the output noise voltage is linearly proportional to $|Z_O|$. In effect, C_O dictates the high frequency roll-off point of the circuit. Operation in the area titled "Marginally Stable" will cause the output of the regulator to exhibit random bursts of oscillation that decay in an under-damped fashion. Continuous oscillation occurs when operating in the area titled "Unstable". It is suggested that oven testing of the entire circuit be performed with maximum load, minimum input voltage, and minimum ambient temperature.

LM2931 Series

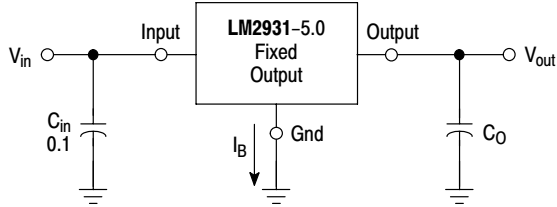
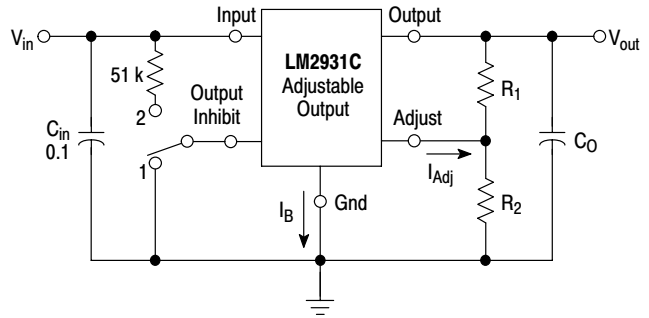

Figure 17. Fixed Output Regulator



Switch Position 1 = Output "On", 2 = Output "Off"

$$V_{out} = V_{ref} \left(1 + \frac{R_2}{R_1} \right) + I_{Adj} R_2 \quad 22.5 \text{ k} \geq \frac{R_1 R_2}{R_1 + R_2}$$

Figure 18. Adjustable Output Regulator

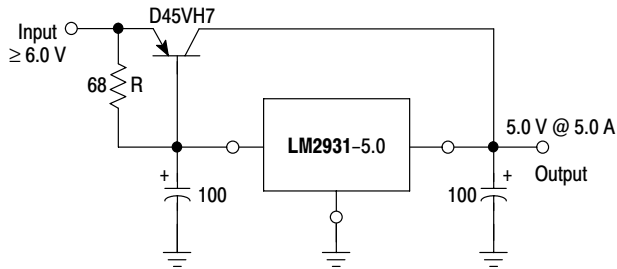

The LM2931 series can be current boosted with a PNP transistor. The D45VH7, on a heatsink, will provide an output current of 5.0 A with an input to output voltage differential of approximately 1.0 V. Resistor R in conjunction with the V_{BE} of the PNP determines when the pass transistor begins conducting. This circuit is not short circuit proof.

Figure 19. (5.0 A) Low Differential Voltage Regulator

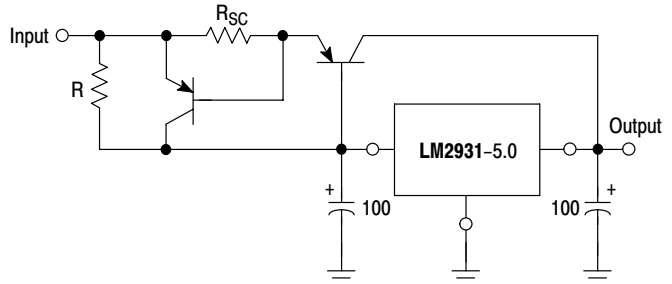

The circuit of Figure 19 can be modified to provide supply protection against short circuits by adding the current sense resistor R_{SC} and an additional PNP transistor. The current sensing PNP must be capable of handling the short circuit current of the LM2931. Safe operating area of both transistors must be considered under worst case conditions.

Figure 20. Current Boost Regulator with Short Circuit Projection

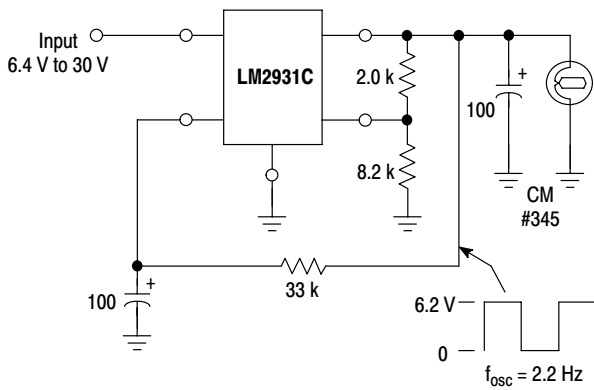

Figure 21. Constant Intensity Lamp Flasher

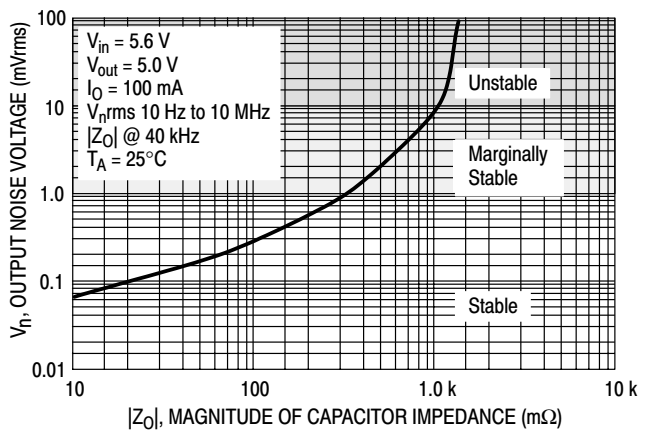

Figure 22. Output Noise Voltage versus Output Capacitor Impedance

LM2931 Series

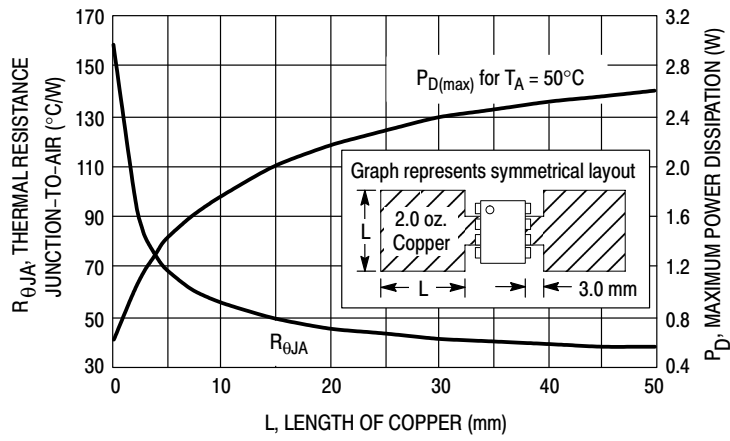

Figure 23. SOP-8 Thermal Resistance and Maximum Power Dissipation versus P.C.B. Copper Length

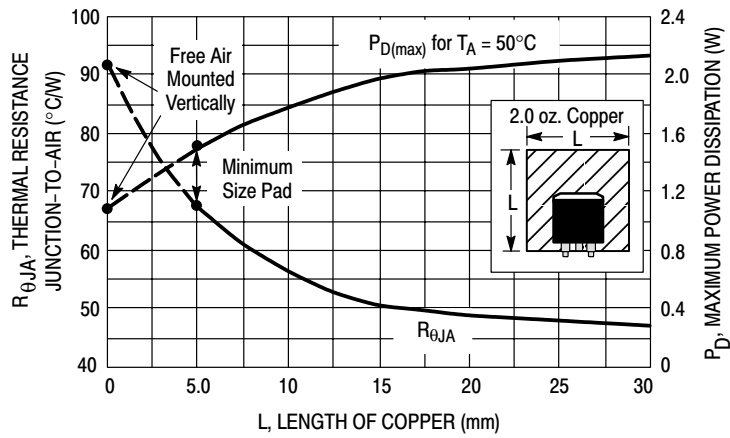

Figure 24. DPAK Thermal Resistance and Maximum Power Dissipation versus P.C.B. Copper Length

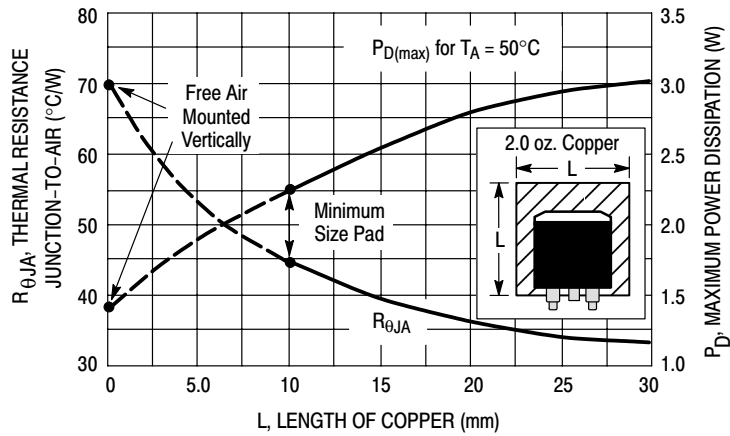

Figure 25. 3-Pin and 5-Pin D²PAK Thermal Resistance and Maximum Power Dissipation versus P.C.B. Copper Length

LM2931 Series

DEFINITIONS

Dropout Voltage – The input/output voltage differential at which the regulator output no longer maintains regulation against further reductions in input voltage. Measured when the output decreases 100 mV from nominal value at 14 V input, dropout voltage is affected by junction temperature and load current.

Line Regulation – The change in output voltage for a change in the input voltage. The measurement is made under conditions of low dissipation or by using pulse techniques such that the average chip temperature is not significantly affected.

Load Regulation – The change in output voltage for a change in load current at constant chip temperature.

Maximum Power Dissipation – The maximum total device dissipation for which the regulator will operate within specifications.

Bias Current – That part of the input current that is not delivered to the load.

Output Noise Voltage – The rms AC voltage at the output, with constant load and no input ripple, measured over a specified frequency range.

Long-Term Stability – Output voltage stability under accelerated life test conditions with the maximum rated voltage listed in the devices electrical characteristics and maximum power dissipation.

LM2931 Series

ORDERING INFORMATION

Device	Output		Package	Shipping
	Voltage	Tolerance		
LM2931AD-5.0	5.0 V	± 3.8%	SOIC-8	98 Units/Rail
LM2931AD-5.0R2			SOIC-8	2500 Tape & Reel
NCV2931AD-5.0R2*			SOIC-8	2500 Tape & Reel
LM2931ADT-5.0			DPAK	75 Units/Rail
LM2931ADT-5.0RK			DPAK	2500 VacPk Reel
LM2931AD2T-5.0			D ² PAK	50 Units/Rail
LM2931AD2T-5.0R4			D ² PAK	800 VacPk Reel
LM2931AT-5.0			TO-220	50 Units/Rail
LM2931AZ-5.0			TO-92	2000/Inner Bag
LM2931AZ-5.0RA			TO-92	2000 Tape & Reel
LM2931AZ-5.0RP		TO-92	2000/Ammo Pack	
LM2931D-5.0		± 5.0%	SOIC-8	98 Units/Rail
LM2931D-5.0R2			SOIC-8	2500 Tape & Reel
LM2931D2T-5.0			D ² PAK	50 Units/Rail
LM2931D2T-5.0R4			D ² PAK	800 VacPk Reel
LM2931DT-5.0			DPAK	75 Units/Rail
LM2931T-5.0			TO-220	50 Units/Rail
LM2931Z-5.0			TO-92	2000/Inner Bag
LM2931Z-5.0RA			TO-92	2000 Tape & Reel
LM2931Z-5.0RP			TO-92	2000/Ammo Pack
LM2931CD	Adjustable		± 2.0%	SOIC-8
LM2931CDR2		SOIC-8		2500 Tape & Reel
LM2931CD2T		D ² PAK		50 Units/Rail
LM2931CD2TR4		D ² PAK		800 VacPk Reel
LM2931CT		TO-220		50 Units/Rail
LM2931ACD		± 2.0%	SOIC-8	98 Units/Rail
LM2931ACDR2			SOIC-8	2500 Tape & Reel
LM2931ACD2TR4			D ² PAK	800 VacPk Reel
LM2931ACTV			TO-220	50 Units/Rail

*NCV2931: T_{low} = -40°C, T_{high} = +125°C. Guaranteed by design. NCV prefix is for automotive and other applications requiring site and change control.

LM2931 Series

MARKING DIAGRAMS

**DPAK
DT SUFFIX
CASE 369A**



**DPAK
DT SUFFIX
CASE 369A**



**D2PAK
D2T SUFFIX
CASE 936**



**D2PAK
D2T SUFFIX
CASE 936**

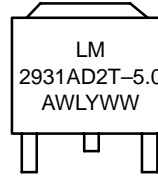

**D2PAK
D2T SUFFIX
CASE 936**

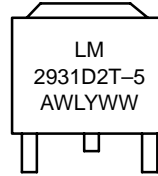

Heatsink surface (shown as terminal 4 in case outline drawing) is connected to Pin 2.

**TO-220
T SUFFIX
CASE 221A**

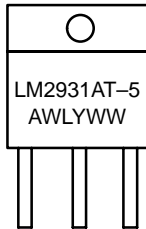

Heatsink surface connected to Pin 2.

**TO-220
T SUFFIX
CASE 221A**

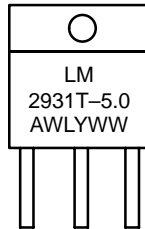

**TO-220
T SUFFIX
CASE 314D**



Heatsink surface connected to Pin 3.

**D2PAK
D2T SUFFIX
CASE 936A**



Heatsink surface (shown as terminal 6 in case outline drawing) is connected to Pin 3.

**D2PAK
D2T SUFFIX
CASE 936A**

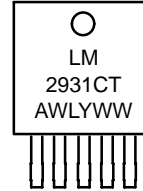

**SO-8
D SUFFIX
CASE 751**

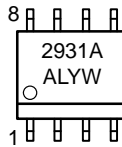

**SO-8
D SUFFIX
CASE 751**

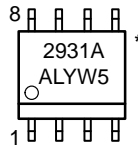

**SO-8
D SUFFIX
CASE 751**

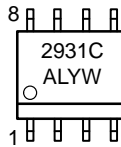

**SO-8
D SUFFIX
CASE 751**

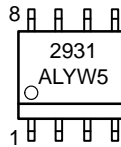

**TO-92
Z SUFFIX
CASE 029**



**TO-92
Z SUFFIX
CASE 029**

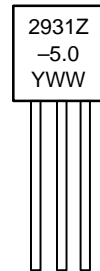

A = Assembly Location
WL, L = Wafer Lot
YY, Y = Year
WW, W = Work Week

*This marking diagram also applies to NCV2931AD.

LM2931 Series

PACKAGE DIMENSIONS

TO-92
Z SUFFIX
CASE 29-11
ISSUE AL

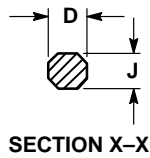
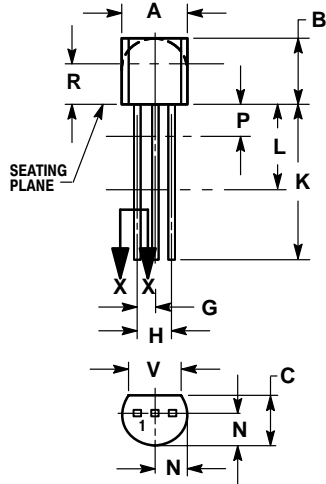

NOTES:

1. DIMENSIONING AND TOLERANCING PER ANSI Y14.5M, 1982.
2. CONTROLLING DIMENSION: INCH.
3. CONTOUR OF PACKAGE BEYOND DIMENSION R IS UNCONTROLLED.
4. LEAD DIMENSION IS UNCONTROLLED IN P AND BEYOND DIMENSION K MINIMUM.

DIM	INCHES		MILLIMETERS	
	MIN	MAX	MIN	MAX
A	0.175	0.205	4.45	5.20
B	0.170	0.210	4.32	5.33
C	0.125	0.165	3.18	4.19
D	0.016	0.021	0.407	0.533
G	0.045	0.055	1.15	1.39
H	0.095	0.105	2.42	2.66
J	0.015	0.020	0.39	0.50
K	0.500	---	12.70	---
L	0.250	---	6.35	---
N	0.080	0.105	2.04	2.66
P	---	0.100	---	2.54
R	0.115	---	2.93	---
V	0.135	---	3.43	---

TO-220
T SUFFIX
CASE 221A-09
ISSUE AA

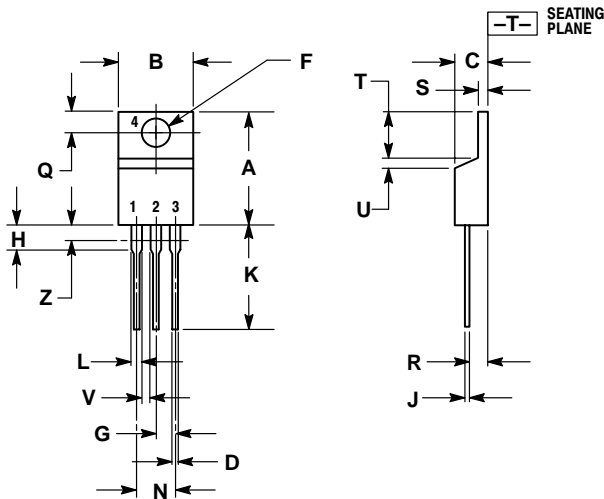

NOTES:

1. DIMENSIONING AND TOLERANCING PER ANSI Y14.5M, 1982.
2. CONTROLLING DIMENSION: INCH.
3. DIMENSION Z DEFINES A ZONE WHERE ALL BODY AND LEAD IRREGULARITIES ARE ALLOWED.

DIM	INCHES		MILLIMETERS	
	MIN	MAX	MIN	MAX
A	0.570	0.620	14.48	15.75
B	0.380	0.405	9.66	10.28
C	0.160	0.190	4.07	4.82
D	0.025	0.035	0.64	0.88
F	0.142	0.147	3.61	3.73
G	0.095	0.105	2.42	2.66
H	0.110	0.155	2.80	3.93
J	0.018	0.025	0.46	0.64
K	0.500	0.562	12.70	14.27
L	0.045	0.060	1.15	1.52
N	0.190	0.210	4.83	5.33
Q	0.100	0.120	2.54	3.04
R	0.080	0.110	2.04	2.79
S	0.045	0.055	1.15	1.39
T	0.235	0.255	5.97	6.47
U	0.000	0.050	0.00	1.27
V	0.045	---	1.15	---
Z	---	0.080	---	2.04

LM2931 Series

PACKAGE DIMENSIONS

TO-220
TH SUFFIX
CASE 314A-03
ISSUE E

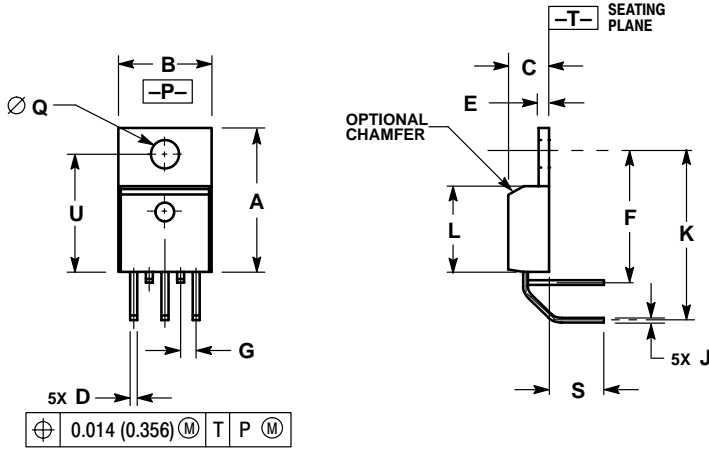

- NOTES:
1. DIMENSIONING AND TOLERANCING PER ANSI Y14.5M, 1982.
 2. CONTROLLING DIMENSION: INCH.
 3. DIMENSION D DOES NOT INCLUDE INTERCONNECT BAR (DAMBAR) PROTRUSION. DIMENSION D INCLUDING PROTRUSION SHALL NOT EXCEED 0.043 (1.092) MAXIMUM.

DIM	INCHES		MILLIMETERS	
	MIN	MAX	MIN	MAX
A	0.572	0.613	14.529	15.570
B	0.390	0.415	9.906	10.541
C	0.170	0.180	4.318	4.572
D	0.025	0.038	0.635	0.965
E	0.048	0.055	1.219	1.397
F	0.570	0.585	14.478	14.859
G	0.067 BSC		1.702 BSC	
J	0.015	0.025	0.381	0.635
K	0.730	0.745	18.542	18.923
L	0.320	0.365	8.128	9.271
Q	0.140	0.153	3.556	3.886
S	0.210	0.260	5.334	6.604
U	0.468	0.505	11.888	12.827

TO-220
TV SUFFIX
CASE 314B-05
ISSUE J

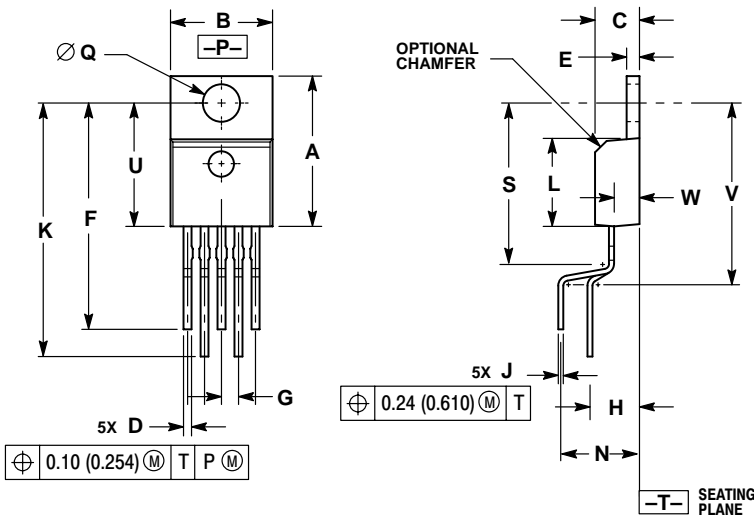

- NOTES:
1. DIMENSIONING AND TOLERANCING PER ANSI Y14.5M, 1982.
 2. CONTROLLING DIMENSION: INCH.
 3. DIMENSION D DOES NOT INCLUDE INTERCONNECT BAR (DAMBAR) PROTRUSION. DIMENSION D INCLUDING PROTRUSION SHALL NOT EXCEED 0.043 (1.092) MAXIMUM.

DIM	INCHES		MILLIMETERS	
	MIN	MAX	MIN	MAX
A	0.572	0.613	14.529	15.570
B	0.390	0.415	9.906	10.541
C	0.170	0.180	4.318	4.572
D	0.025	0.038	0.635	0.965
E	0.048	0.055	1.219	1.397
F	0.850	0.935	21.590	23.749
G	0.067 BSC		1.702 BSC	
H	0.166 BSC		4.216 BSC	
J	0.015	0.025	0.381	0.635
K	0.900	1.100	22.860	27.940
L	0.320	0.365	8.128	9.271
N	0.320 BSC		8.128 BSC	
Q	0.140	0.153	3.556	3.886
S	---	0.620	---	15.748
U	0.468	0.505	11.888	12.827
V	---	0.735	---	18.669
W	0.090	0.110	2.286	2.794

LM2931 Series

PACKAGE DIMENSIONS

TO-220
T SUFFIX
CASE 314D-04
ISSUE E

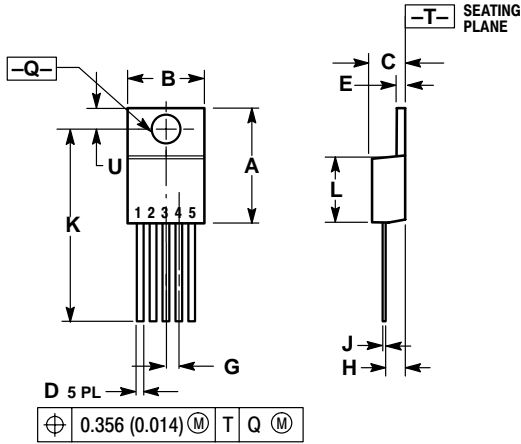

- NOTES:
1. DIMENSIONING AND TOLERANCING PER ANSI Y14.5M, 1982.
 2. CONTROLLING DIMENSION: INCH.
 3. DIMENSION D DOES NOT INCLUDE INTERCONNECT BAR (DAMBAR) PROTRUSION. DIMENSION D INCLUDING PROTRUSION SHALL NOT EXCEED 10.92 (0.043) MAXIMUM.

DIM	INCHES		MILLIMETERS	
	MIN	MAX	MIN	MAX
A	0.572	0.613	14.529	15.570
B	0.390	0.415	9.906	10.541
C	0.170	0.180	4.318	4.572
D	0.025	0.038	0.635	0.965
E	0.048	0.055	1.219	1.397
G	0.067 BSC		1.702 BSC	
H	0.087	0.112	2.210	2.845
J	0.015	0.025	0.381	0.635
K	0.990	1.045	25.146	26.543
L	0.320	0.365	8.128	9.271
Q	0.140	0.153	3.556	3.886
U	0.105	0.117	2.667	2.972

DPAK
DT SUFFIX
CASE 369A-13
ISSUE AB

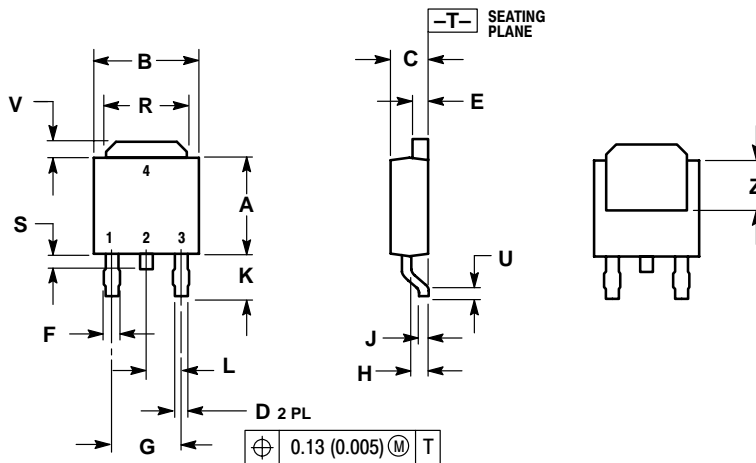

- NOTES:
1. DIMENSIONING AND TOLERANCING PER ANSI Y14.5M, 1982.
 2. CONTROLLING DIMENSION: INCH.

DIM	INCHES		MILLIMETERS	
	MIN	MAX	MIN	MAX
A	0.235	0.250	5.97	6.35
B	0.250	0.265	6.35	6.73
C	0.086	0.094	2.19	2.38
D	0.027	0.035	0.69	0.88
E	0.033	0.040	0.84	1.01
F	0.037	0.047	0.94	1.19
G	0.180 BSC		4.58 BSC	
H	0.034	0.040	0.87	1.01
J	0.018	0.023	0.46	0.58
K	0.102	0.114	2.60	2.89
L	0.090 BSC		2.29 BSC	
R	0.175	0.215	4.45	5.46
S	0.020	0.050	0.51	1.27
U	0.020	---	0.51	---
V	0.030	0.050	0.77	1.27
Z	0.138	---	3.51	---

LM2931 Series

PACKAGE DIMENSIONS

SOIC-8 D SUFFIX CASE 751-07 ISSUE W

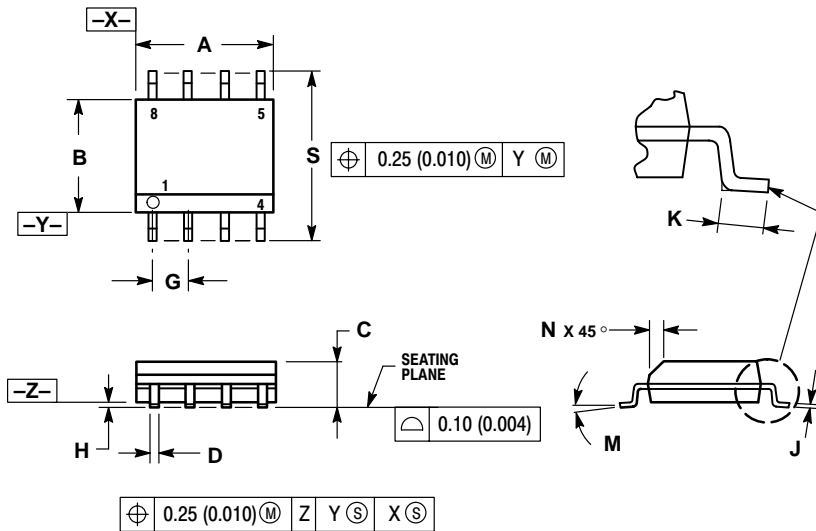

- NOTES:
1. DIMENSIONING AND TOLERANCING PER ANSI Y14.5M, 1982.
 2. CONTROLLING DIMENSION: MILLIMETER.
 3. DIMENSION A AND B DO NOT INCLUDE MOLD PROTRUSION.
 4. MAXIMUM MOLD PROTRUSION 0.15 (0.006) PER SIDE.
 5. DIMENSION D DOES NOT INCLUDE DAMBAR PROTRUSION. ALLOWABLE DAMBAR PROTRUSION SHALL BE 0.127 (0.005) TOTAL IN EXCESS OF THE D DIMENSION AT MAXIMUM MATERIAL CONDITION.

DIM	MILLIMETERS		INCHES	
	MIN	MAX	MIN	MAX
A	4.80	5.00	0.189	0.197
B	3.80	4.00	0.150	0.157
C	1.35	1.75	0.053	0.069
D	0.33	0.51	0.013	0.020
G	1.27 BSC		0.050 BSC	
H	0.10	0.25	0.004	0.010
J	0.19	0.25	0.007	0.010
K	0.40	1.27	0.016	0.050
M	0°	8°	0°	8°
N	0.25	0.50	0.010	0.020
S	5.80	6.20	0.228	0.244

D²PAK D2T SUFFIX CASE 936-03 ISSUE B

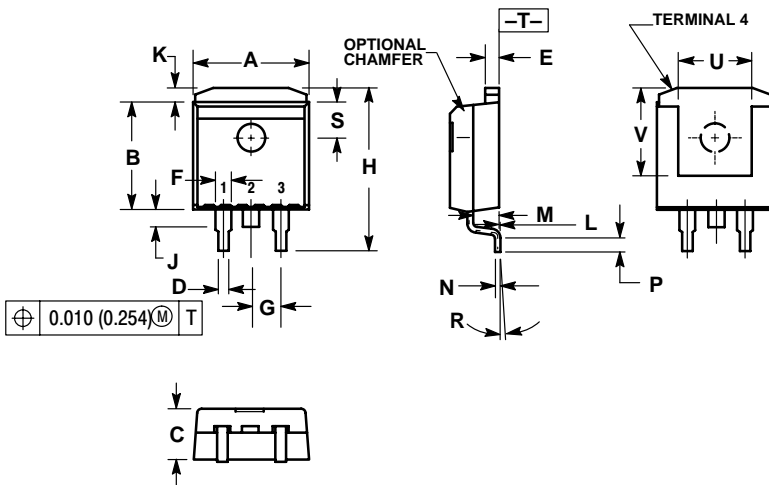

- NOTES:
1. DIMENSIONING AND TOLERANCING PER ANSI Y14.5M, 1982.
 2. CONTROLLING DIMENSION: INCH.
 3. TAB CONTOUR OPTIONAL WITHIN DIMENSIONS A AND K.
 4. DIMENSIONS U AND V ESTABLISH A MINIMUM MOUNTING SURFACE FOR TERMINAL 4.
 5. DIMENSIONS A AND B DO NOT INCLUDE MOLD FLASH OR GATE PROTRUSIONS. MOLD FLASH AND GATE PROTRUSIONS NOT TO EXCEED 0.025 (0.635) MAXIMUM.

DIM	INCHES		MILLIMETERS	
	MIN	MAX	MIN	MAX
A	0.386	0.403	9.804	10.236
B	0.356	0.368	9.042	9.347
C	0.170	0.180	4.318	4.572
D	0.026	0.036	0.660	0.914
E	0.045	0.055	1.143	1.397
F	0.051 REF		1.295 REF	
G	0.100 BSC		2.540 BSC	
H	0.539	0.579	13.691	14.707
J	0.125 MAX		3.175 MAX	
K	0.050 REF		1.270 REF	
L	0.000	0.010	0.000	0.254
M	0.088	0.102	2.235	2.591
N	0.018	0.026	0.457	0.660
P	0.058	0.078	1.473	1.981
R	5° REF		5° REF	
S	0.116 REF		2.946 REF	
U	0.200 MIN		5.080 MIN	
V	0.250 MIN		6.350 MIN	

LM2931 Series

PACKAGE DIMENSIONS

D²PAK
D2T SUFFIX
 CASE 936A-02
 ISSUE B

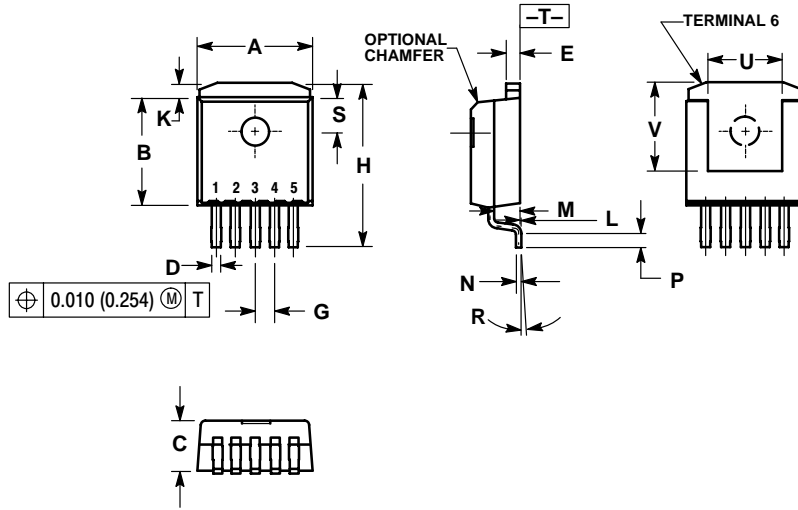

NOTES:

1. DIMENSIONING AND TOLERANCING PER ANSI Y14.5M, 1982.
2. CONTROLLING DIMENSION: INCH.
3. TAB CONTOUR OPTIONAL WITHIN DIMENSIONS A AND K.
4. DIMENSIONS U AND V ESTABLISH A MINIMUM MOUNTING SURFACE FOR TERMINAL 6.
5. DIMENSIONS A AND B DO NOT INCLUDE MOLD FLASH OR GATE PROTRUSIONS. MOLD FLASH AND GATE PROTRUSIONS NOT TO EXCEED 0.025 (0.635) MAXIMUM.

DIM	INCHES		MILLIMETERS	
	MIN	MAX	MIN	MAX
A	0.386	0.403	9.804	10.236
B	0.356	0.368	9.042	9.347
C	0.170	0.180	4.318	4.572
D	0.026	0.036	0.660	0.914
E	0.045	0.055	1.143	1.397
G	0.067 BSC		1.702 BSC	
H	0.539	0.579	13.691	14.707
K	0.050 REF		1.270 REF	
L	0.000	0.010	0.000	0.254
M	0.088	0.102	2.235	2.591
N	0.018	0.026	0.457	0.660
P	0.058	0.078	1.473	1.981
R	5° REF		5° REF	
S	0.116 REF		2.946 REF	
U	0.200 MIN		5.080 MIN	
V	0.250 MIN		6.350 MIN	

Notes

LM2931 Series

ON Semiconductor and  are registered trademarks of Semiconductor Components Industries, LLC (SCILLC). SCILLC reserves the right to make changes without further notice to any products herein. SCILLC makes no warranty, representation or guarantee regarding the suitability of its products for any particular purpose, nor does SCILLC assume any liability arising out of the application or use of any product or circuit, and specifically disclaims any and all liability, including without limitation special, consequential or incidental damages. "Typical" parameters which may be provided in SCILLC data sheets and/or specifications can and do vary in different applications and actual performance may vary over time. All operating parameters, including "Typicals" must be validated for each customer application by customer's technical experts. SCILLC does not convey any license under its patent rights nor the rights of others. SCILLC products are not designed, intended, or authorized for use as components in systems intended for surgical implant into the body, or other applications intended to support or sustain life, or for any other application in which the failure of the SCILLC product could create a situation where personal injury or death may occur. Should Buyer purchase or use SCILLC products for any such unintended or unauthorized application, Buyer shall indemnify and hold SCILLC and its officers, employees, subsidiaries, affiliates, and distributors harmless against all claims, costs, damages, and expenses, and reasonable attorney fees arising out of, directly or indirectly, any claim of personal injury or death associated with such unintended or unauthorized use, even if such claim alleges that SCILLC was negligent regarding the design or manufacture of the part. SCILLC is an Equal Opportunity/Affirmative Action Employer.

PUBLICATION ORDERING INFORMATION

Literature Fulfillment:

Literature Distribution Center for ON Semiconductor
P.O. Box 5163, Denver, Colorado 80217 USA
Phone: 303-675-2175 or 800-344-3860 Toll Free USA/Canada
Fax: 303-675-2176 or 800-344-3867 Toll Free USA/Canada
Email: ONlit@hibbertco.com

N. American Technical Support: 800-282-9855 Toll Free USA/Canada

JAPAN: ON Semiconductor, Japan Customer Focus Center
4-32-1 Nishi-Gotanda, Shinagawa-ku, Tokyo, Japan 141-0031
Phone: 81-3-5740-2700
Email: r14525@onsemi.com

ON Semiconductor Website: <http://onsemi.com>

For additional information, please contact your local Sales Representative.