

## DS75361 Dual TTL-to-MOS Driver

### General Description

The DS75361 is a monolithic integrated dual TTL-to-MOS driver interface circuit. The device accepts standard TTL input signals and provides high-current and high-voltage output levels for driving MOS circuits. It is used to drive address, control, and timing inputs for several types of MOS RAMs including the 1103 and MM5270 and MM5280.

The DS75361 operates from standard TTL 5V supplies and the MOS  $V_{SS}$  supply in many applications. The device has been optimized for operation with  $V_{CC2}$  supply voltage from 16V to 20V; however, it is designed for use over a much wider range of  $V_{CC2}$ .

### Features

- Capable of driving high-capacitance loads
- Compatible with many popular MOS RAMs
- $V_{CC2}$  supply voltage variable over wide range to 24V
- Diode-clamped inputs
- TTL compatible
- Operates from standard bipolar and MOS supplies
- High-speed switching
- Transient overdrive minimizes power dissipation
- Low standby power dissipation

### Schematic and Connection Diagrams

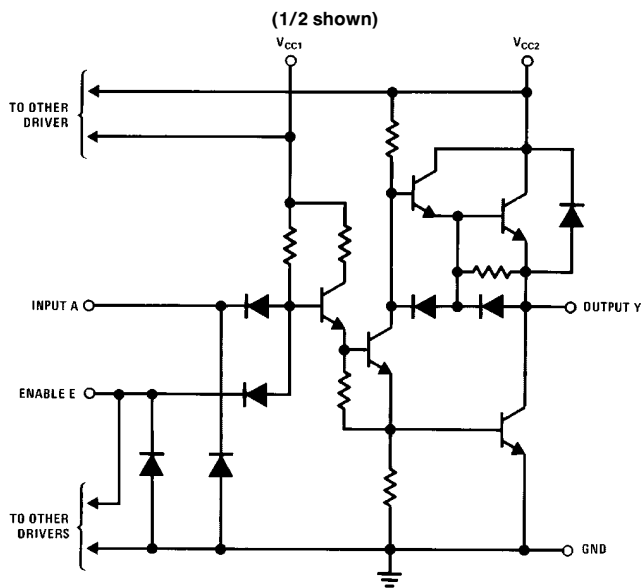

TL/F/7557-3

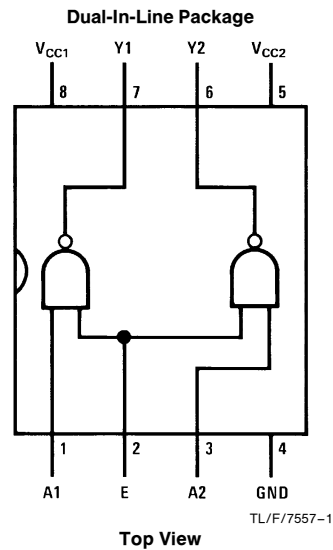

TL/F/7557-1

Order Number DS75361N  
See NS Package Number N08E

## Absolute Maximum Ratings (Note 1)

If Military/Aerospace specified devices are required, please contact the National Semiconductor Sales Office/Distributors for availability and specifications.

Supply Voltage Range of $V_{CC1}$ (Note 1)	-0.5 to 7V
Supply Voltage Range of $V_{CC2}$	-0.5V to 25V
Input Voltage	5.5V
Inter-Input Voltage (Note 4)	5.5V
Storage Temperature Range	-65°C to +150°C
Maximum Power Dissipation* at 25°C	
Molded Package	1022 mW

Lead Temperature 1/16 inch from Case for  
10 Seconds: N or P Package 200°C  
\*Derate molded package 8.2 mW/° above about 25°C.

## Operating Conditions

	Min	Max	Units
Supply Voltage ( $V_{CC1}$ )	4.75	5.25	V
Supply Voltage ( $V_{CC2}$ )	4.75	24	V
Operating Temperature ( $T_A$ )	0	+70	°C

## Electrical Characteristics (Notes 2 and 3)

Symbol	Parameter	Conditions	Min	Typ	Max	Units
$V_{IH}$	High-Level Input Voltage		2			V
$V_{IL}$	Low-Level Input Voltage				0.8	V
$V_I$	Input Clamp Voltage	$I_I = -12$ mA			-1.5	V
$V_{OH}$	High-Level Output Voltage	$V_{IL} = 0.8$ V, $I_{OH} = -50$ $\mu$ A	$V_{CC2} - 1$	$V_{CC2} - 0.7$		V
		$V_{IL} = 0.8$ V, $I_{OH} = -10$ mA	$V_{CC2} - 2.3$	$V_{CC2} - 1.8$		V
$V_{OL}$	Low-Level Output Voltage	$V_{IH} = 2$ V, $I_{OL} = 10$ mA		0.15	0.3	V
		$V_{CC2} = 15$ V to 24V, $V_{IH} = 2$ V, $I_{OL} = 40$ mA		0.25	0.5	V
$V_O$	Output Clamp Voltage	$V_I = 0$ V, $I_{OH} = 20$ mA			$V_{CC2} + 1.5$	V
$I_I$	Input Current at Maximum Input Voltage	$V_I = 5.5$ V			1	mA
$I_{IH}$	High-Level Input Current	$V_I = 2.4$ V	A Inputs		40	$\mu$ A
			E Input		80	$\mu$ A
$I_{IL}$	Low-Level Input Current	$V_I = 0.4$ V	A Inputs	-1	-1.6	mA
			E Input	-2	-3.2	mA
$I_{CC1(H)}$	Supply Current from $V_{CC1}$ , Both Outputs High	$V_{CC1} = 5.25$ V, $V_{CC2} = 24$ V, All Inputs at 0V, No Load		2	4	mA
$I_{CC2(H)}$	Supply Current from $V_{CC2}$ , Both Outputs High				0.5	mA
$I_{CC1(L)}$	Supply Current from $V_{CC1}$ , Both Outputs Low	$V_{CC1} = 5.25$ V, $V_{CC2} = 24$ V, All Inputs at 5V, No Load		16	24	mA
$I_{CC2(L)}$	Supply Current from $V_{CC2}$ , Both Outputs Low			7	11	mA
$I_{CC2(S)}$	Supply Current from $V_{CC2}$ , Stand-by Condition	$V_{CC1} = 0$ V, $V_{CC2} = 24$ V, All Inputs at 5V, No Load			0.5	mA

**Note 1:** "Absolute Maximum Ratings" are those values beyond which the safety of the device cannot be guaranteed. Except for "Operating Temperature Range" they are not meant to imply that the devices should be operated at these limits. The table of "Electrical Characteristics" provides conditions for actual device operation.

**Note 2:** Unless otherwise specified min/max limits apply across the 0°C to +70°C range for the DS75361. All typical values are for  $T_A = 25^\circ\text{C}$  and  $V_{CC1} = 5$  V and  $V_{CC2} = 20$  V.

**Note 3:** All currents into device pins shown as positive, out of device pins as negative, all voltages referenced to ground unless otherwise noted. All values shown as max or min on absolute value basis.

**Note 4:** This rating applies between the A input of either driver and the common E input.

### Switching Characteristics $V_{CC1} = 5V, V_{CC2} = 20V, T_A = 25^\circ C$

Symbol	Parameter	Conditions	Min	Typ	Max	Units
$t_{DLH}$	Delay Time, Low-to-High Level Output	$C_L = 390\text{ pF},$ $R_D = 10\Omega$ (Figure 1)		11	20	ns
$t_{DHL}$	Delay Time, High-to-Low Level Output			10	18	ns
$t_{TLH}$	Transition Time, Low-to-High Level Output			25	40	ns
$t_{THL}$	Transition Time, High-to-Low Level Output			21	35	ns
$t_{PLH}$	Propagation Delay Time, Low-to-High Level Output			10	36	ns
$t_{PHL}$	Propagation Delay Time, High-to-Low Level Output			10	31	ns

### AC Test Circuit and Switching Time Waveforms

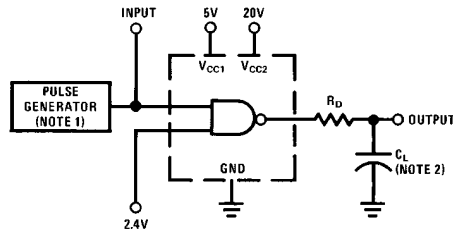

TL/F/7557-4

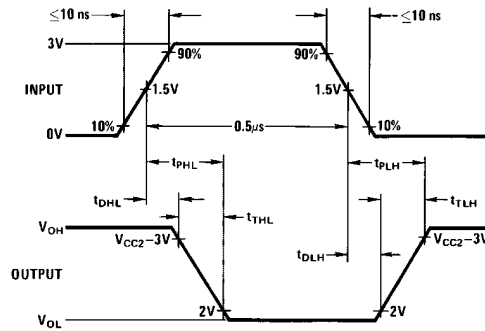

TL/F/7557-5

**Note 1:** The pulse generator has the following characteristics: PRR = 1 MHz, Z<sub>OUT</sub> = 50Ω.

**Note 2:** C<sub>L</sub> includes probe and jig capacitance.

**FIGURE 1. Switching Times, Each Driver**

# Typical Performance Characteristics

**High-Level Output Voltage vs Output Current**

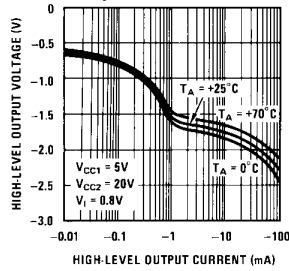

**Low-Level Output Voltage vs Output Current**

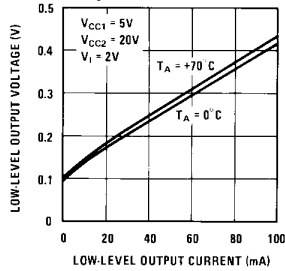

**Voltage Transfer Characteristics**

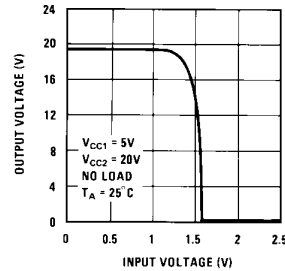

**Total Dissipation (Both Drivers) vs Frequency**

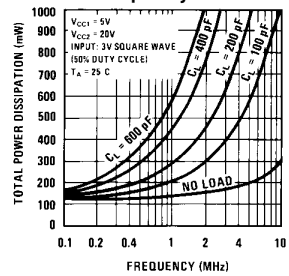

**Propagation Delay Time, Low-to-High Level Output vs Ambient Temperature**

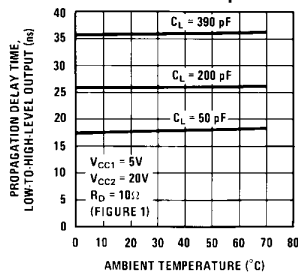

**Propagation Delay Time, High-to-Low Level Output vs Ambient Temperature**

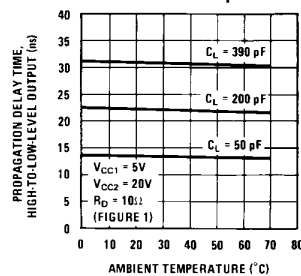

**Propagation Delay Time, Low-to-High Level Output vs VCC2 Supply Voltage**

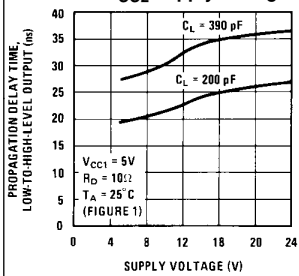

**Propagation Delay Time, High-to-Low Level Output vs VCC2 Supply Voltage**

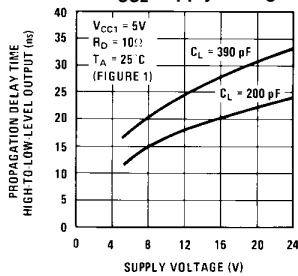

**Propagation Delay Time, Low-to-High Level Output vs Load Capacitance**

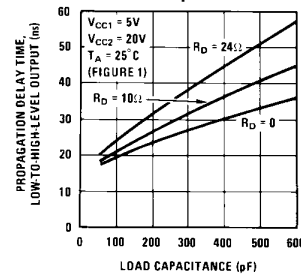

**Propagation Delay Time, High-to-Low Level Output vs Load Capacitance**

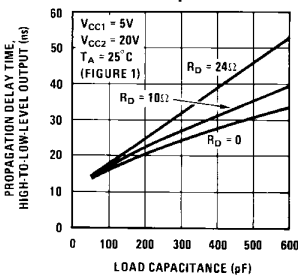

TL/F/7557-2

## Typical Applications

The fast switching speeds of this device may produce undesirable output transient overshoot because of load or wiring inductance. A small series damping resistor may be used to reduce or eliminate this output transient overshoot. The

optimum value of the damping resistor to use depends on the specific load characteristics and switching speed. A typical value would be between 10Ω and 30Ω (Figure 3).

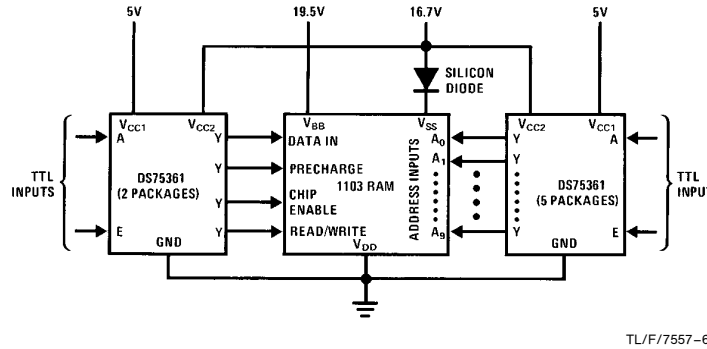
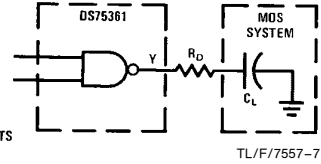

FIGURE 2. Interconnection of DS75361 Devices with 1103 RAM



Note:  $R_D \approx 10\Omega$  to  $30\Omega$  (Optional).

FIGURE 3. Use of Damping Resistor to Reduce or Eliminate Output Transient Overshoot in Certain DS75361 Applications

## Thermal Information

### POWER DISSIPATION PRECAUTIONS

Significant power may be dissipated in the DS75361 driver when charging and discharging high-capacitance loads over a wide voltage range at high frequencies. The total dissipation curve shows the power dissipated in a typical DS75361 as a function of load capacitance and frequency. Average power dissipated by this driver can be broken into three components:

$$P_{T(AV)} = P_{DC(AV)} + P_{C(AV)} + P_{S(AV)}$$

where  $P_{DC(AV)}$  is the steady-state power dissipation with the output high or low,  $P_{C(AV)}$  is the power level during charging or discharging of the load capacitance, and  $P_{S(AV)}$  is the power dissipation during switching between the low and high levels. None of these include energy transferred to the load and all are averaged over a full cycle.

The power components per driver channel are:

$$P_{DC(AV)} = \frac{P_L t_L + P_H t_H}{T}$$

$$P_{C(AV)} \approx C V_C^2 f$$

$$P_{S(AV)} = \frac{P_{LH} t_{LH} + P_{HL} t_{HL}}{T}$$

where the times are defined in Figure 4.

$P_L$ ,  $P_H$ ,  $P_{LH}$ , and  $P_{HL}$  are the respective instantaneous levels of power dissipation and  $C$  is load capacitance.

The DS75361 is so designed that  $P_S$  is a negligible portion of  $P_T$  in most applications. Except at very high frequencies,  $t_L + t_H \gg t_{LH} + t_{HL}$  so that  $P_S$  can be neglected. The total dissipation curve for no load demonstrates this point. The power dissipation contributions from both channels are then added together to obtain total device power.

The following example illustrates this power calculation technique. Assume both channels are operating identically with  $C = 200$  pF,  $f = 2$  MHz,  $V_{CC1} = 5$  V,  $V_{CC2} = 20$  V, and duty cycle = 60% outputs high ( $t_H/T = 0.6$ ). Also, assume  $V_{OH} = 19.3$  V,  $V_{OL} = 0.1$  V,  $P_S$  is negligible, and that the current from  $V_{CC2}$  is negligible when the output is high.

On a per-channel basis using data sheet values:

$$P_{DC(AV)} = \left[ (5V) \left( \frac{2 \text{ mA}}{2} \right) + (20V) \left( \frac{0 \text{ mA}}{2} \right) \right] (0.6) +$$

$$\left[ (5V) \left( \frac{16 \text{ mA}}{2} \right) + (20V) \left( \frac{7 \text{ mA}}{2} \right) \right] (0.4)$$

$$P_{DC(AV)} = 47 \text{ mW per channel}$$

$$P_{C(AV)} \approx (200 \text{ pF}) (19.2V)^2 (2 \text{ MHz})$$

$$P_{C(AV)} \approx 148 \text{ mW per channel.}$$

For the total device dissipation of the two channels:

$$P_{T(AV)} \approx 2 (47 + 148)$$

$$P_{T(AV)} \approx 390 \text{ mW typical for total package.}$$

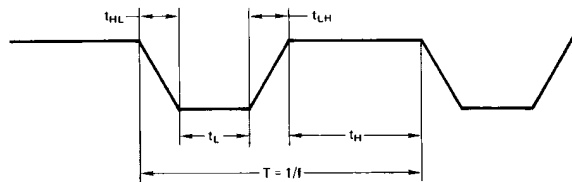
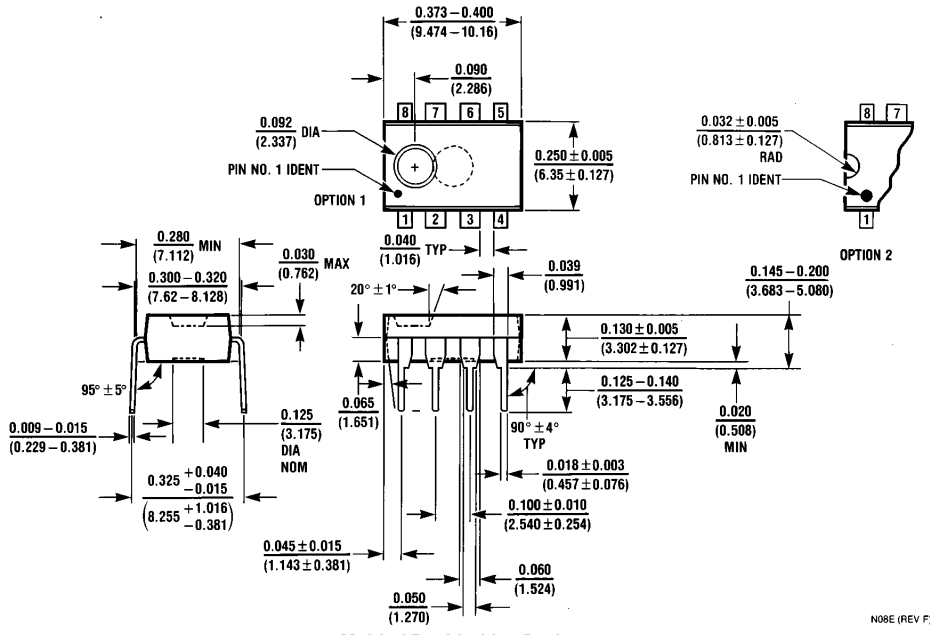

FIGURE 4. Output Voltage Waveform

TL/F/7557-8

**Physical Dimensions** inches (millimeters)



**Molded Dual-In-Line Package**  
**Order Number DS75361N**  
**See NS Package Number N08E**

**LIFE SUPPORT POLICY**

NATIONAL'S PRODUCTS ARE NOT AUTHORIZED FOR USE AS CRITICAL COMPONENTS IN LIFE SUPPORT DEVICES OR SYSTEMS WITHOUT THE EXPRESS WRITTEN APPROVAL OF THE PRESIDENT OF NATIONAL SEMICONDUCTOR CORPORATION. As used herein:

1. Life support devices or systems are devices or systems which, (a) are intended for surgical implant into the body, or (b) support or sustain life, and whose failure to perform, when properly used in accordance with instructions for use provided in the labeling, can be reasonably expected to result in a significant injury to the user.
2. A critical component is any component of a life support device or system whose failure to perform can be reasonably expected to cause the failure of the life support device or system, or to affect its safety or effectiveness.

 <p><b>National Semiconductor Corporation</b>          1111 West Bardin Road          Arlington, TX 76017          Tel: 1(800) 272-9959          Fax: 1(800) 737-7018</p>	<p><b>National Semiconductor Europe</b>          Fax: (+49) 0-180-530 85 86          Email: cnjwge@tevm2.nsc.com          Deutsch Tel: (+49) 0-180-530 85 85          English Tel: (+49) 0-180-532 78 32          Français Tel: (+49) 0-180-532 93 58          Italiano Tel: (+49) 0-180-534 16 80</p>	<p><b>National Semiconductor Hong Kong Ltd.</b>          19th Floor, Straight Block,          Ocean Centre, 5 Canton Rd.          Tsimshatsui, Kowloon          Hong Kong          Tel: (852) 2737-1600          Fax: (852) 2736-9960</p>	<p><b>National Semiconductor Japan Ltd.</b>          Tel: 81-043-299-2309          Fax: 81-043-299-2408</p>
--	--	---	---

National does not assume any responsibility for use of any circuitry described, no circuit patent licenses are implied and National reserves the right at any time without notice to change said circuitry and specifications.