

DS1692/DS3692 TRI-STATE® Differential Line Drivers

General Description

The DS1692/DS3692 are low power Schottky TTL line drivers electrically similar to the DS1691A/DS3691 but tested to meet the requirements of MIL-STD-188-114A (see Application Note AN-216). MIL-STD-188-114A type 1 driver specifications can be met by adding an external three resistor voltage divider to the output of the DS3692/1692. The DS3692/1692 feature 4 buffered outputs with high source and sink current capability with internal short circuit protection.

With the mode select pin low, the DS1692/DS3692 are dual differential line drivers with TRI-STATE outputs. They feature $\pm 10V$ output common-mode range in TRI-STATE and 0V output unbalance when operated with $\pm 5V$ supply.

Multipoint applications in differential mode with waveshaping capacitors is not allowed.

Features

- Short circuit protection for both source and sink outputs
- 100 Ω transmission line drive capability
- Low I_{CC} and I_{EE} power consumption: Differential mode: $I_{CC} = 9$ mA/driver typ, $I_{EE} = 5$ mA/driver typ
- Low current PNP inputs compatible with TTL, MOS and CMOS
- Adaptable as MIL-STD-188-114A type 1 driver

Logic Diagram (1/2 Circuit Shown)

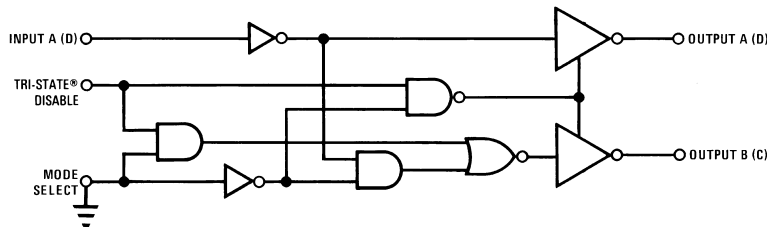

DS005784-1

Connection Diagram

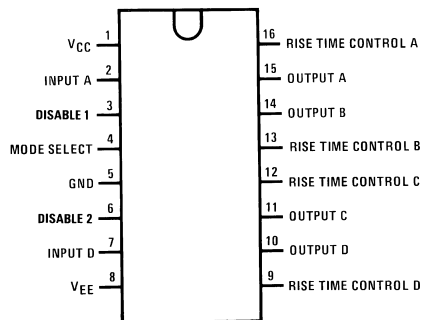

DS005784-2

*Contact Product Marketing for availability.

Top View
Order Number DS1692J, DS3692J,
DS3692M or DS3692N
See NS Package Number J16A, M16A* or N16A

Mode	Inputs		Outputs	
	A (D)	Disable1 (2)	A (D)	B (C)
0	0	0	0	1
0	0	1	TRI-STATE	TRI-STATE
0	1	0	1	0
0	1	1	TRI-STATE	TRI-STATE

TRI-STATE® is a registered trademark of National Semiconductor Corporation.

Absolute Maximum Ratings (Note 2)

If Military/Aerospace specified devices are required, please contact the National Semiconductor Sales Office/Distributors for availability and specifications.

Supply Voltage		
V_{CC}	7V	
V_{EE}	-7V	
Maximum Power Dissipation (Note 1) at 25°C		
Cavity Package	1509 mW	
Molded Package	1476 mW	
Input Voltage	15V	
Output Voltage (Power OFF)	±15V	
Storage Temperature	-65°C to +150°C	
Lead Temperature (Soldering, 4 sec.)	260°C	

Operating Conditions

	Min	Max	Units
Supply Voltage			
DS1692			
V_{CC}	4.5	5.5	V
V_{EE}	-4.5	-5.5	V
DS3692			
V_{CC}	4.75	5.25	V
V_{EE}	-4.75	-5.25	V
Temperature (T_A)			
DS1692	-55	+125	°C
DS3692	0	+70	°C

Note 1: Derate cavity package 10.1 mW/°C; derate molded package 11.9 mW/°C above 25°C.

Electrical Characteristics

DS1692/DS3692 (Notes 3, 4, 5)

Symbol	Parameter	Conditions	Min	Typ	Max	Units
DS1692, $V_{CC} = 5V \pm 10\%$, DS3692, $V_{CC} = 5V \pm 5\%$, V_{EE} CONNECTION TO GROUND, MODE SELECT $\leq 0.8V$						
V_O	Differential Output Voltage	$R_L = \infty$				
$\overline{V_O}$	$V_{A,B}$	$V_{IN} = 2V$	2.5	3.6		V
		$V_{IN} = 0.8V$	-2.5	-3.6		V
V_T	Differential Output Voltage	$R_L = 100\Omega$				
$\overline{V_T}$	$V_{A,B}$	$V_{CC} \geq 4.75V$				
		$V_{IN} = 2V$	2	2.6		V
		$V_{IN} = 0.8V$	-2	-2.6		V
$V_{OS}, \overline{V_{OS}}$	Common-Mode Offset Voltage	$R_L = 100\Omega$		2.5	3	V
$ V_T - \overline{V_T} $	Difference in Differential Output Voltage	$R_L = 100\Omega$		0.05	0.4	V
$ V_{OS} - \overline{V_{OS}} $	Difference in Common-Mode Offset Voltage	$R_L = 100\Omega$		0.05	0.4	V
V_{SS}	$ V_T - \overline{V_T} $	$R_L = 100\Omega, V_{CC} \geq 4.75V$	4.0	4.8		V
I_{OX}	TRI-STATE Output Current	$V_O \leq -10V$		-0.002	-0.15	mA
		$V_O \geq 15V$		0.002	0.15	mA
I_{SA}	Output Short Circuit Current	$V_{IN} = 0.4V$				
		$V_{OA} = 6V$		80	150	mA
		$V_{OB} = 0V$		-80	-150	mA
I_{SB}	Output Short Circuit Current	$V_{IN} = 2.4V$				
		$V_{OA} = 0V$		-80	-150	mA
		$V_{OB} = 6V$		80	150	mA
I_{CC}	Supply Current			18	30	mA
DS1692, $V_{CC} = 5V \pm 10\%$, $V_{EE} = -5V \pm 10\%$, DS3692, $V_{CC} = 5V \pm 5\%$, $V_{EE} = -5 \pm 5\%$, MODE SELECT $\leq 0.8V$						
V_O	Differential Output Voltage	$R_L = \infty$				
$\overline{V_O}$	$V_{A,B}$	$V_{IN} = 2.4V$	7	8.5		V
		$V_{IN} = 0.4V$	-7	-8.5		V
V_T	Differential Output Voltage	$R_L = 200\Omega$				
$\overline{V_T}$	$V_{A,B}$	$V_{IN} = 2.4V$	6	7.3		V
		$V_{IN} = 0.4V$	-6	-7.3		V
$ V_T - \overline{V_T} $	Output Unbalance	$ V_{CC} = V_{EE} , R_L = 200\Omega$		0.02	0.4	V
I_{OX}	TRI-STATE Output Current					
		$V_O = 10V$		0.002	0.15	mA
		$V_O = -10V$		-0.002	-0.15	mA
I_{S^+}	Output Short Circuit Current	$V_O = 0V$				
		$V_{IN} = 2.4V$		-80	-150	mA
I_{S^-}		$V_{IN} = 0.4V$		80	150	mA
I_{SLEW}	Slew Control Current			±140		µA
I_{CC}	Positive Supply Current	$V_{IN} = 0.4V, R_L = \infty$		18	30	mA
I_{EE}	Negative Supply Current	$V_{IN} = 0.4V, R_L = \infty$		-10	-22	mA

Electrical Characteristics

$V_{EE} \leq 0V$ (Notes 3, 4)

Symbol	Parameter	Conditions	Min	Typ	Max	Units	
V_{IH}	High Level Input Voltage		2			V	
V_{IL}	Low Level Input Voltage				0.8	V	
I_{IH}	High Level Input Current	$V_{IN} = 2.4V$		1	40	μA	
		$V_{IN} \leq 15V$		10	100	μA	
I_{IL}	Low Level Input Current	$V_{IN} = 0.4V$		-30	-200	μA	
V_I	Input Clamp Voltage	$I_{IN} = -12 mA$			-1.5	V	
I_{XA}	Output Leakage Current	$V_{CC} = V_{EE} = 0V$		$V_O = 15V$	0.01	0.15	mA
I_{XB}	Power OFF			$V_O = -15V$	-0.01	-0.15	mA

Switching Characteristics

$T_A = 25^\circ C$

Symbol	Parameter	Conditions	Min	Typ	Max	Units
$V_{CC} = 5V$, $MODE\ SELECT = 0.8V$						
t_r	Differential Output Rise Time	$R_L = 100\Omega$, $C_L = 500 pF$ (Figure 1)		120	200	ns
t_f	Differential Output Fall Time	$R_L = 100\Omega$, $C_L = 500 pF$ (Figure 1)		120	200	ns
t_{PDH}	Output Propagation Delay	$R_L = 100\Omega$, $C_L = 500 pF$ (Figure 1)		120	200	ns
t_{PDL}	Output Propagation Delay	$R_L = 100\Omega$, $C_L = 500 pF$ (Figure 1)		120	200	ns
t_{PZL}	TRI-STATE Delay	$R_L = 100\Omega$, $C_L = 500 pF$ (Figure 2)		180	250	ns
t_{PZH}	TRI-STATE Delay	$R_L = 100\Omega$, $C_L = 500 pF$ (Figure 2)		180	250	ns
t_{PLZ}	TRI-STATE Delay	$R_L = 100\Omega$, $C_L = 500 pF$ (Figure 2)		80	150	ns
t_{PHZ}	TRI-STATE Delay	$R_L = 100\Omega$, $C_L = 500 pF$ (Figure 2)		80	150	ns
$V_{CC} = 5V$, $V_{EE} = -5V$, $MODE\ SELECT = 0.8V$						
t_r	Differential Output Rise Time	$R_L = 200\Omega$, $C_L = 500 pF$ (Figure 1)		190	300	ns
t_f	Differential Output Fall Time	$R_L = 200\Omega$, $C_L = 500 pF$ (Figure 1)		190	300	ns
t_{PDL}	Output Propagation Delay	$R_L = 200\Omega$, $C_L = 500 pF$ (Figure 1)		190	300	ns
t_{PDH}	Output Propagation Delay	$R_L = 200\Omega$, $C_L = 500 pF$ (Figure 1)		190	300	ns
t_{PZL}	TRI-STATE Delay	$R_L = 200\Omega$, $C_L = 500 pF$ (Figure 2)		180	250	ns
t_{PZH}	TRI-STATE Delay	$R_L = 200\Omega$, $C_L = 500 pF$ (Figure 2)		180	250	ns
t_{PLZ}	TRI-STATE Delay	$R_L = 200\Omega$, $C_L = 500 pF$ (Figure 2)		80	150	ns
t_{PHZ}	TRI-STATE Delay	$R_L = 200\Omega$, $C_L = 500 pF$ (Figure 2)		80	150	ns

Note 2: "Absolute Maximum Ratings" are those values beyond which the safety of the device cannot be guaranteed. They are not meant to imply that the devices should be operated at these limits. The table of "Electrical Characteristics" provide conditions for actual device operation.

Note 3: Unless otherwise specified, min/max limits apply across the $-55^\circ C$ to $+125^\circ C$ temperature range for the DS1692 and across the $0^\circ C$ to $+70^\circ C$ range for the DS3692. All typicals are given for $V_{CC} = 5V$ and $T_A = 25^\circ C$. V_{CC} and V_{EE} as listed in operating conditions.

Note 4: All currents into device pins are positive; all currents out of device pins are negative. All voltages are referenced to ground unless otherwise specified.

Note 5: Only one output at a time should be shorted.

AC Test Circuits and Switching Time Waveforms

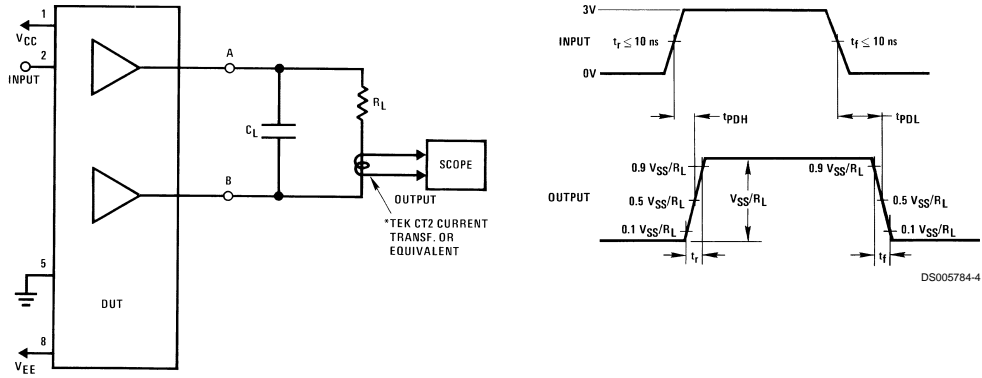

FIGURE 1. Differential Connection

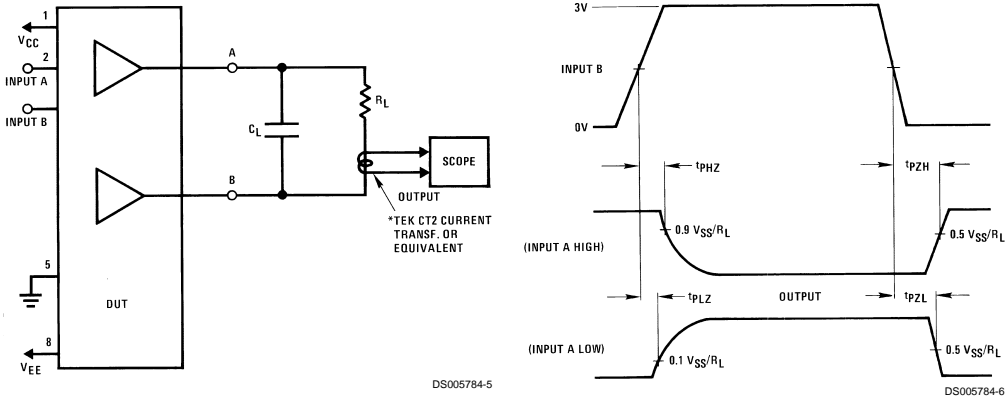
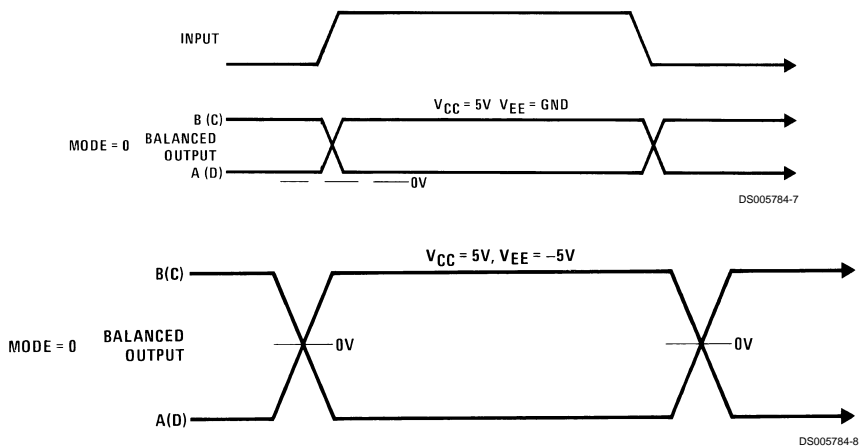
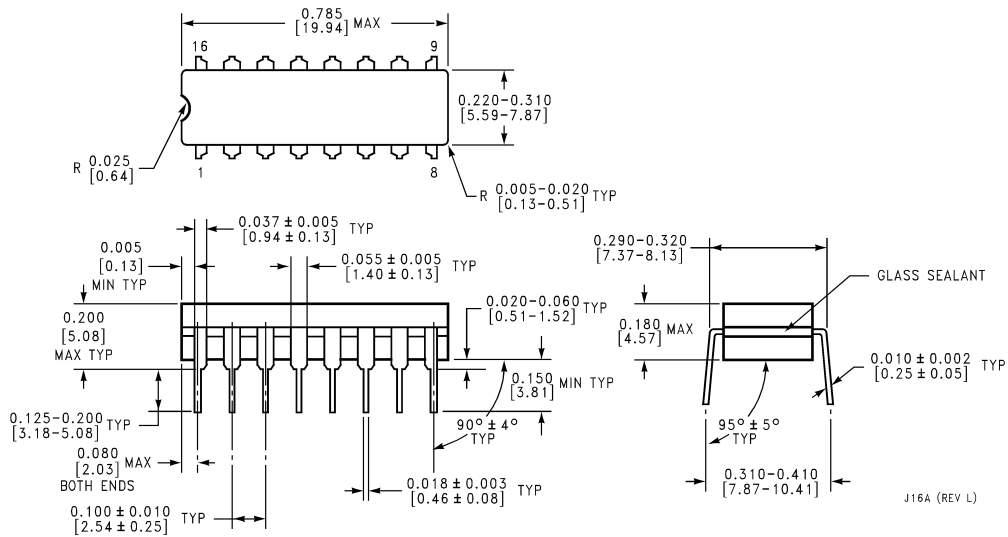

FIGURE 2. TRI-STATE Delays for DS1692/DS3692

Switching Waveforms



Physical Dimensions inches (millimeters) unless otherwise noted



Ceramic Dual-In-Line Package (J)
Order Number DS1692J, DS3692J
NS Package Number J16A

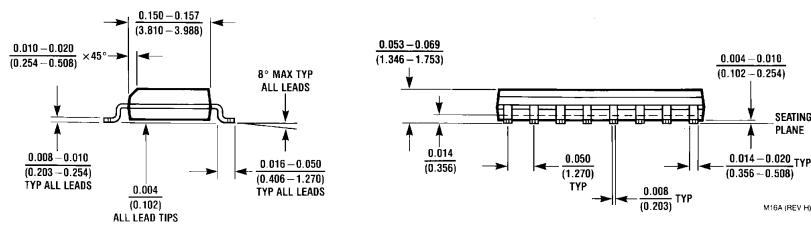
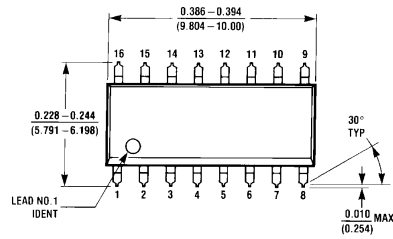

Small Outline Package (M)
Order Number DS3692M
NS Package Number M16A

Physical Dimensions inches (millimeters) unless otherwise noted (Continued)

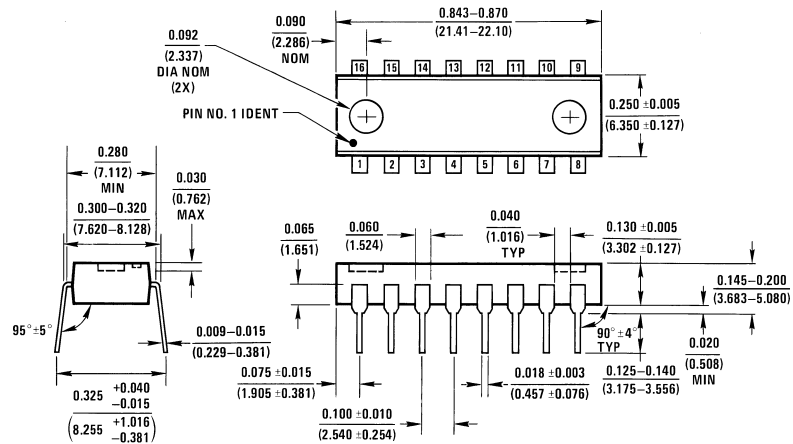

Molded Dual-In-Line Package (N)
Order Number DS3692N
NS Package Number N16A

N16A (REV E)

LIFE SUPPORT POLICY

NATIONAL'S PRODUCTS ARE NOT AUTHORIZED FOR USE AS CRITICAL COMPONENTS IN LIFE SUPPORT DEVICES OR SYSTEMS WITHOUT THE EXPRESS WRITTEN APPROVAL OF THE PRESIDENT AND GENERAL COUNSEL OF NATIONAL SEMICONDUCTOR CORPORATION. As used herein:

1. Life support devices or systems are devices or systems which, (a) are intended for surgical implant into the body, or (b) support or sustain life, and whose failure to perform when properly used in accordance with instructions for use provided in the labeling, can be reasonably expected to result in a significant injury to the user.
2. A critical component is any component of a life support device or system whose failure to perform can be reasonably expected to cause the failure of the life support device or system, or to affect its safety or effectiveness.



National Semiconductor Corporation
 Americas
 Tel: 1-800-272-9959
 Fax: 1-800-737-7018
 Email: support@nsc.com

National Semiconductor Europe
 Fax: +49 (0) 1 80-530 85 86
 Email: europe.support@nsc.com
 Deutsch Tel: +49 (0) 1 80-530 85 85
 English Tel: +49 (0) 1 80-532 78 32
 Français Tel: +49 (0) 1 80-532 93 58
 Italiano Tel: +49 (0) 1 80-534 16 80

National Semiconductor Asia Pacific Customer Response Group
 Tel: 65-2544466
 Fax: 65-2504466
 Email: sea.support@nsc.com

National Semiconductor Japan Ltd.
 Tel: 81-3-5639-7560
 Fax: 81-3-5639-7507

www.national.com

National does not assume any responsibility for use of any circuitry described, no circuit patent licenses are implied and National reserves the right at any time without notice to change said circuitry and specifications.