

8M-WORD BY 72-BIT
SYNCHRONOUS DYNAMIC RAM MODULE (SO DIMM)**Description**

The MC-458CA721ESA and MC-458CA721PSA are 8,388,608 words by 72 bits synchronous dynamic RAM module (Small Outline DIMM) on which 5 pieces of 128M SDRAM: μ PD45128163 are assembled.

These modules provide high density and large quantities of memory in a small space without utilizing the surface-mounting technology on the printed circuit board.

Decoupling capacitors are mounted on power supply line for noise reduction.

Features

- 8,388,608 words by 72 bits organization (ECC type)
- Clock frequency and access time from CLK

Part number	/CAS latency	Clock frequency (MAX.)	Access time from CLK (MAX.)
MC-458CA721ESA-A80	CL = 3	125 MHz	6 ns
	CL = 2	100 MHz	6 ns
MC-458CA721ESA-A10	CL = 3	100 MHz	6 ns
	CL = 2	77 MHz	7 ns
★ MC-458CA721PSA-A80	CL = 3	125 MHz	6 ns
	CL = 2	100 MHz	6 ns
★ MC-458CA721PSA-A10	CL = 3	100 MHz	6 ns
	CL = 2	77 MHz	7 ns

- Fully Synchronous Dynamic RAM, with all signals referenced to a positive clock edge
- Pulsed interface
- Possible to assert random column address in every cycle
- Quad internal banks controlled by BA0, BA1 (Bank Select)
- Programmable burst-length (1, 2, 4, 8 and Full Page)
- Programmable wrap sequence (Sequential/Interleave)
- Programmable /CAS latency (2, 3)
- Automatic precharge and controlled precharge
- CBR (Auto) refresh and self refresh
- Single 3.3V \pm 0.3V power supply
- LVTTTL compatible
- 4,096 refresh cycles/64 ms
- Burst termination by Burst Stop command and Precharge command
- 144-pin small outline dual in-line memory module (Pin pitch = 0.8 mm)
- Unbuffered type
- Serial PD

The information in this document is subject to change without notice. Before using this document, please confirm that this is the latest version.
Not all devices/types available in every country. Please check with local NEC representative for availability and additional information.

Ordering Information

Part number	Clock frequency MHz (MAX.)	Package	Mounted devices
MC-458CA721ESA-A80	125 MHz	144-pin Small Outline DIMM (Socket Type) Edge connector: Gold plated 31.75 mm height	5 piece of μ PD45128163G5 (Rev. E) (10.16mm (400) TSOP (II))
MC-458CA721ESA-A10	100 MHz		
★ MC-458CA721PSA-A80	125 MHz		5 piece of μ PD45128163G5 (Rev. P) (10.16mm (400) TSOP (II))
★ MC-458CA721PSA-A10	100 MHz		

Pin Configuration

144-pin Dual In-line Memory Module Socket Type (Edge connector: Gold plated)

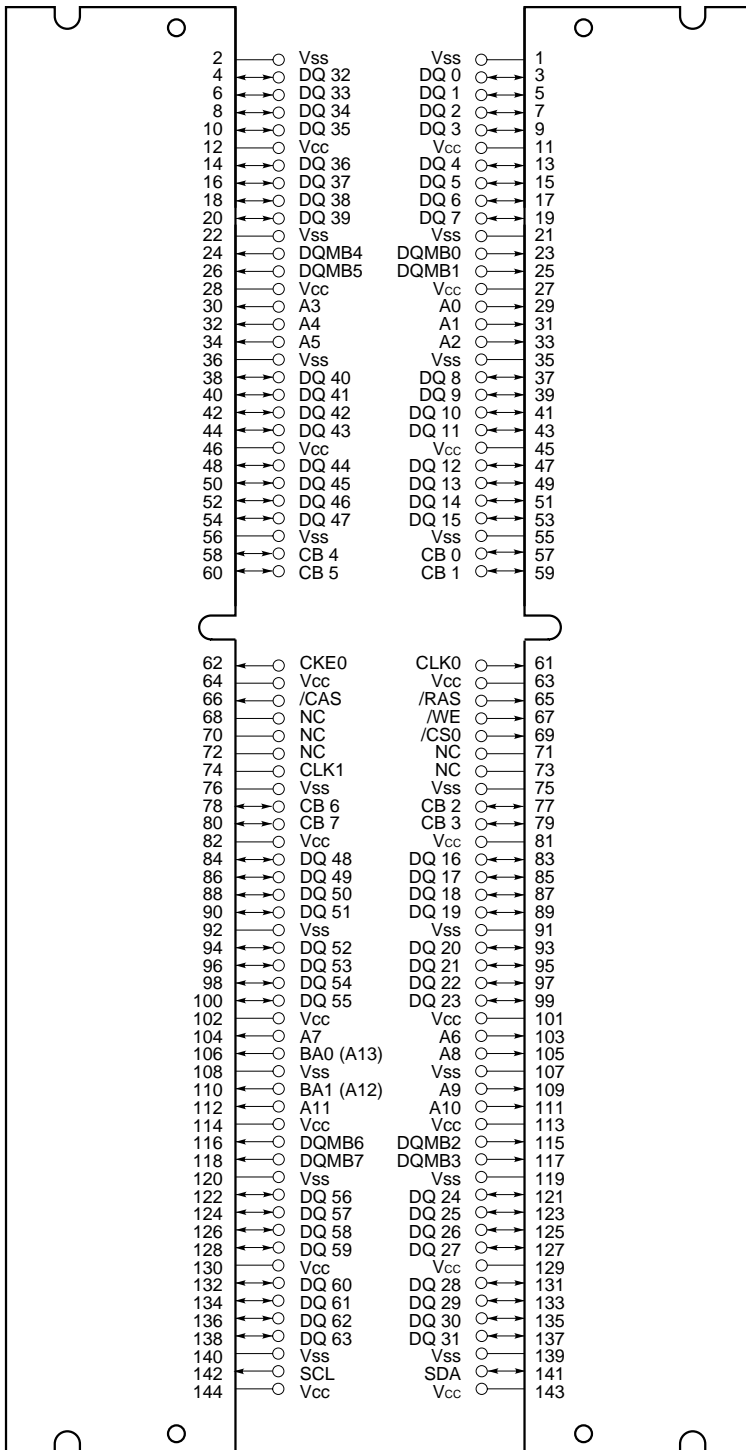

/xxx indicates active low signal.

- A0 - A11 : Address Inputs
[Row: A0 - A11, Column: A0 - A8]
- BA0(A13), BA1(A12) : SDRAM Bank Select
- DQ0 - DQ63 : Data Inputs/Outputs
- CB0 - CB7 : Data Inputs/Outputs
- CLK0, CLK1 : Clock Input
- CKE0 : Clock Enable Input
- /CS0 : Chip Select Input
- /RAS : Row Address Strobe
- /CAS : Column Address Strobe
- /WE : Write Enable
- DQMB0 - DQMB7 : DQ Mask Enable
- SDA : Serial Data I/O for PD
- SCL : Clock Input for PD
- Vcc : Power Supply
- Vss : Ground
- NC : No Connection

Block Diagram

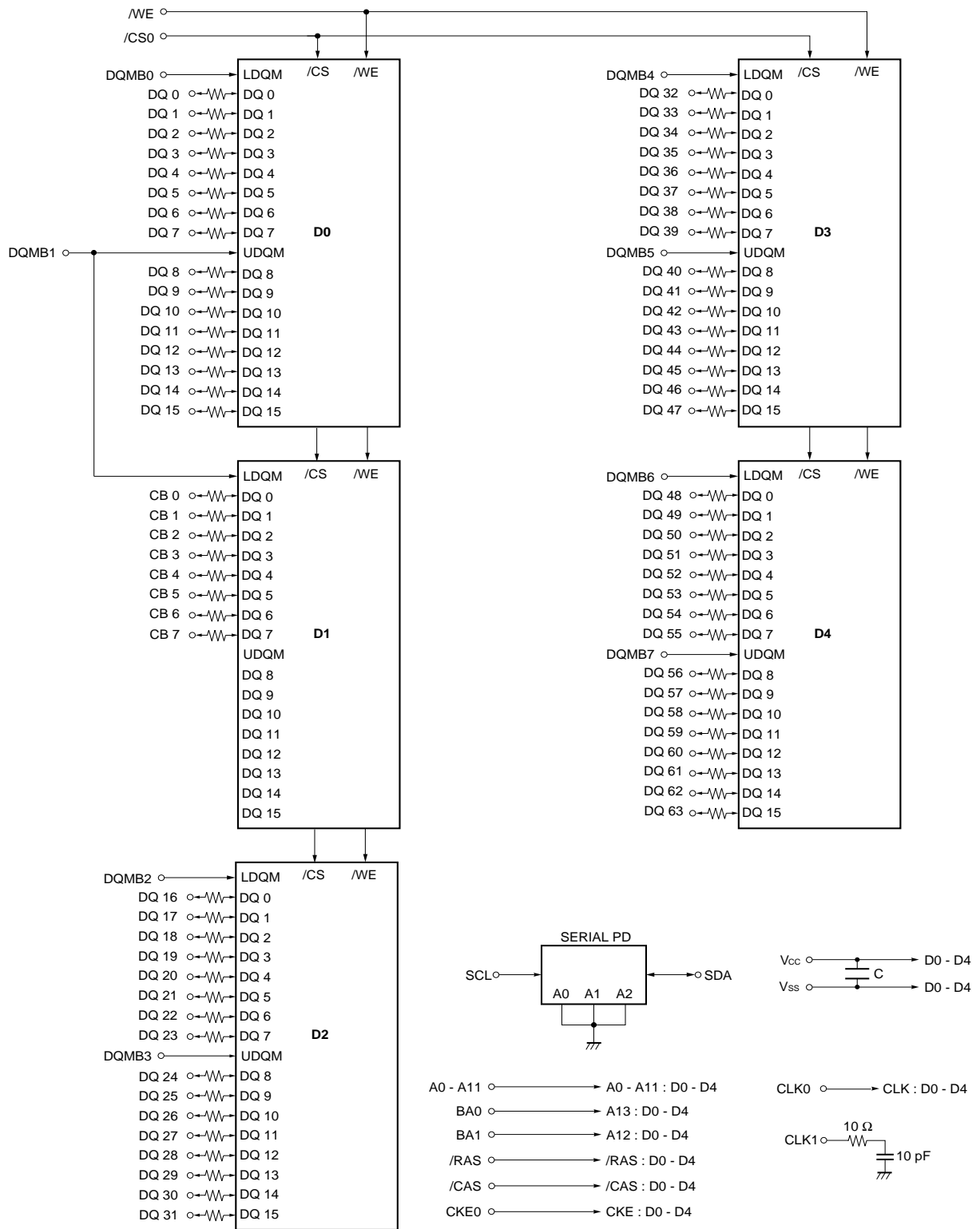

- Remarks**
1. D0 – D4: μ PD45128163 (2M words x 16 bits x 4 banks)
 2. The value of all resistors is 10 Ω .

Electrical Specifications

- All voltages are referenced to V_{SS} (GND).
- After power up, wait more than 100 μs and then, execute power on sequence and CBR (Auto) refresh before proper device operation is achieved.

Absolute Maximum Ratings

Parameter	Symbol	Condition	Rating	Unit
Voltage on power supply pin relative to GND	V _{CC}		-0.5 to +4.6	V
Voltage on input pin relative to GND	V _T		-0.5 to +4.6	V
Short circuit output current	I _O		50	mA
Power dissipation	P _D		5	W
Operating ambient temperature	T _A		0 to 70	°C
Storage temperature	T _{stg}		-55 to +125	°C

Caution Exposing the device to stress above those listed in Absolute Maximum Ratings could cause permanent damage. The device is not meant to be operated under conditions outside the limits described in the operational section of this specification. Exposure to Absolute Maximum Rating conditions for extended periods may affect device reliability.

Recommended Operating Conditions

Parameter	Symbol	Condition	MIN.	TYP.	MAX.	Unit
Supply voltage	V _{CC}		3.0	3.3	3.6	V
High level input voltage	V _{IH}		2.0		V _{CC} + 0.3	V
Low level input voltage	V _{IL}		-0.3		+0.8	V
Operating ambient temperature	T _A		0		70	°C

Capacitance (T_A = 25 °C, f = 1 MHz)

Parameter	Symbol	Test condition	MIN.	TYP.	MAX.	Unit
Input capacitance	C _{I1}	A0 - A11, BA0(A13), BA1(A12), /RAS, /CAS, /WE	17		34	pF
	C _{I2}	CLK0	23		37	
	C _{I3}	CKE0	18		30	
	C _{I4}	/CS0	18		30	
	C _{I5}	DQMB0 - DQMB7	5		16.5	
Data input/output capacitance	C _{I/O}	DQ0 - DQ63, CB0 - CB7	5		13	pF

DC Characteristics (Recommended Operating Conditions unless otherwise noted)

Parameter	Symbol	Test condition			MIN.	MAX.	Unit	Notes
Operating current	I _{CC1}	Burst length = 1, t _{RC} ≥ t _{RC(MIN.)}	/CAS latency = 2	-A80		550	mA	1
				-A10				
			/CAS latency = 3	-A80		550		
				-A10				
★ Precharge standby current in power down mode	I _{CC2P}	CKE ≤ V _{IL(MAX.)} , t _{CK} = 15 ns				5	mA	
	I _{CC2PS}	CKE ≤ V _{IL(MAX.)} , t _{CK} = ∞				5		
Precharge standby current in non power down mode	I _{CC2N}	CKE ≥ V _{IH(MIN.)} , t _{CK} = 15 ns, /CS ≥ V _{IH(MIN.)} , Input signals are changed one time during 30 ns.				100	mA	
	I _{CC2NS}	CKE ≥ V _{IH(MIN.)} , t _{CK} = ∞, Input signals are stable.				40		
Active standby current in power down mode	I _{CC3P}	CKE ≤ V _{IL(MAX.)} , t _{CK} = 15 ns				25	mA	
	I _{CC3PS}	CKE ≤ V _{IL(MAX.)} , t _{CK} = ∞				20		
Active standby current in non power down mode	I _{CC3N}	CKE ≥ V _{IH(MIN.)} , t _{CK} = 15 ns, /CS ≥ V _{IH(MIN.)} , Input signals are changed one time during 30 ns.				150	mA	
	I _{CC3NS}	CKE ≥ V _{IH(MIN.)} , t _{CK} = ∞, Input signals are stable.				100		
Operating current (Burst mode)	I _{CC4}	t _{CK} ≥ t _{CK(MIN.)} , I _O = 0 mA	/CAS latency = 2	-A80		725	mA	2
				-A10		550		
			/CAS latency = 3	-A80		875		
				-A10		700		
★ CBR (Auto) refresh current	I _{CC5}	t _{RC} ≥ t _{RC(MIN.)}	/CAS latency = 2	-A80		1,150	mA	3
				-A10				
			/CAS latency = 3	-A80		1,150		
				-A10				
Self refresh current	I _{CC6}	CKE ≤ 0.2 V				10	mA	
Input leakage current	I _{I(L)}	V _I = 0 to 3.6 V, All other pins not under test = 0 V			-5	+5	μA	
Output leakage current	I _{O(L)}	D _{OUT} is disabled, V _O = 0 to 3.6 V			-1.5	+1.5	μA	
High level output voltage	V _{OH}	I _O = -4.0 mA			2.4		V	
Low level output voltage	V _{OL}	I _O = +4.0 mA				0.4	V	

- Notes**
- I_{CC1} depends on output loading and cycle rates. Specified values are obtained with the output open. In addition to this, I_{CC1} is measured on condition that addresses are changed only one time during t_{CK(MIN.)}.
 - I_{CC4} depends on output loading and cycle rates. Specified values are obtained with the output open. In addition to this, I_{CC4} is measured on condition that addresses are changed only one time during t_{CK(MIN.)}.
 - I_{CC5} is measured on condition that addresses are changed only one time during t_{CK(MIN.)}.

AC Characteristics (Recommended Operating Conditions unless otherwise noted)

★ Test Conditions

Parameter	Value	Unit
AC high level input voltage / low level input voltage	2.4 / 0.4	V
Input timing measurement reference level	1.4	V
Transition time (Input rise and fall time)	1	ns
Output timing measurement reference level	1.4	V

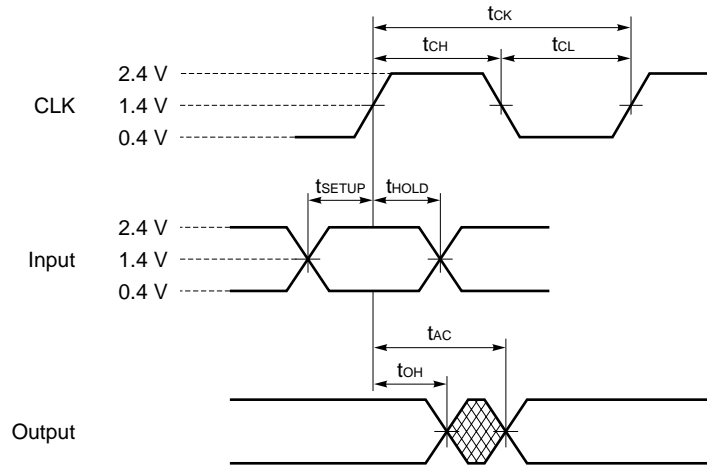

Synchronous Characteristics

Parameter		Symbol	-A80		-A10		Unit	Note
			MIN.	MAX.	MIN.	MAX.		
Clock cycle time	/CAS latency = 3	t _{CK3}	8	(125 MHz)	10	(100 MHz)	ns	
	/CAS latency = 2	t _{CK2}	10	(100 MHz)	13	(77 MHz)	ns	
Access time from CLK	/CAS latency = 3	t _{AC3}		6		6	ns	1
	/CAS latency = 2	t _{AC2}		6		7	ns	1
CLK high level width		t _{CH}	3		3		ns	
CLK low level width		t _{CL}	3		3		ns	
Data-out hold time		t _{OH}	3		3		ns	1
Data-out low-impedance time		t _{LZ}	0		0		ns	
Data-out high-impedance time	/CAS latency = 3	t _{HZ3}	3	6	3	6	ns	
	/CAS latency = 2	t _{HZ2}	3	6	3	7	ns	
Data-in setup time		t _{DS}	2		2		ns	
Data-in hold time		t _{DH}	1		1		ns	
Address setup time		t _{AS}	2		2		ns	
Address hold time		t _{AH}	1		1		ns	
CKE setup time		t _{CKS}	2		2		ns	
CKE hold time		t _{CKH}	1		1		ns	
CKE setup time (Power down exit)		t _{CKSP}	2		2		ns	
Command (/CS0, /RAS, /CAS, /WE, DQMB0 - DQMB7) setup time		t _{CMS}	2		2		ns	
Command (/CS0, /RAS, /CAS, /WE, DQMB0 - DQMB7) hold time		t _{CMH}	1		1		ns	

Note 1. Output load

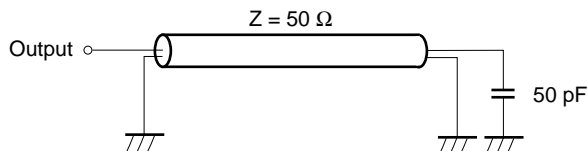

Remark These specifications are applied to the monolithic device.

Asynchronous Characteristics

Parameter	Symbol	-A80		-A10		Unit	Note
		MIN.	MAX.	MIN.	MAX.		
ACT to REF/ACT command period (Operation)	t _{RC}	70		70		ns	
REF to REF/ACT command period (Refresh)	t _{RC1}	70		70		ns	
ACT to PRE command period	t _{RASt}	48	120,000	50	120,000	ns	
PRE to ACT command period	t _{RP}	20		20		ns	
Delay time ACT to READ/WRITE command	t _{RCD}	20		20		ns	
ACT(one) to ACT(another) command period	t _{RRD}	16		20		ns	
Data-in to PRE command period	t _{DPL}	8		10		ns	
Data-in to ACT(REF) command period (Auto precharge)	/CAS latency = 3	t _{DAL3}	1CLK+20	1CLK+20		ns	
	/CAS latency = 2	t _{DAL2}	1CLK+20	1CLK+20		ns	
Mode register set cycle time	t _{RSC}	2		2		CLK	
Transition time	t _T	0.5	30	1	30	ns	
Refresh time (4,096 refresh cycles)	t _{REF}		64		64	ms	

Serial PD

(1/2)

Byte No.	Function Described	Hex	Bit 7	Bit 6	Bit 5	Bit 4	Bit 3	Bit 2	Bit 1	Bit 0	Notes
0	Defines the number of bytes written into serial PD memory	80H	1	0	0	0	0	0	0	0	128 bytes
1	Total number of bytes of serial PD memory	08H	0	0	0	0	1	0	0	0	256 bytes
2	Fundamental memory type	04H	0	0	0	0	0	1	0	0	SDRAM
3	Number of rows	0CH	0	0	0	0	1	1	0	0	12 rows
4	Number of columns	09H	0	0	0	0	1	0	0	1	9 columns
5	Number of banks	01H	0	0	0	0	0	0	0	1	1 bank
6	Data width	48H	0	1	0	0	1	0	0	0	72 bits
7	Data width (continued)	00H	0	0	0	0	0	0	0	0	0
8	Voltage interface	01H	0	0	0	0	0	0	0	1	LVTTTL
9	CL = 3 Cycle time	-A80	80H	1	0	0	0	0	0	0	8 ns
		-A10	A0H	1	0	1	0	0	0	0	10 ns
10	CL = 3 Access time	-A80	60H	0	1	1	0	0	0	0	6 ns
		-A10	60H	0	1	1	0	0	0	0	6 ns
11	DIMM configuration type	02H	0	0	0	0	0	0	1	0	ECC
12	Refresh rate/type	80H	1	0	0	0	0	0	0	0	Normal
13	SDRAM width	10H	0	0	0	1	0	0	0	0	×16
14	Error checking SDRAM width	10H	0	0	0	1	0	0	0	0	×16
15	Minimum clock delay	01H	0	0	0	0	0	0	0	1	1 clock
16	Burst length supported	8FH	1	0	0	0	1	1	1	1	1, 2, 4, 8, F
17	Number of banks on each SDRAM	04H	0	0	0	0	0	1	0	0	4 banks
18	/CAS latency supported	06H	0	0	0	0	0	1	1	0	2, 3
19	/CS latency supported	01H	0	0	0	0	0	0	0	1	0
20	/WE latency supported	01H	0	0	0	0	0	0	0	1	0
21	SDRAM module attributes	00H	0	0	0	0	0	0	0	0	
22	SDRAM device attributes : General	0EH	0	0	0	0	1	1	1	0	
23	CL = 2 Cycle time	-A80	A0H	1	0	1	0	0	0	0	10 ns
		-A10	D0H	1	1	0	1	0	0	0	13 ns
24	CL = 2 Access time	-A80	60H	0	1	1	0	0	0	0	6 ns
		-A10	70H	0	1	1	1	0	0	0	7 ns
25-26		00H	0	0	0	0	0	0	0	0	
27	trp(MIN.)	-A80	14H	0	0	0	1	0	1	0	20 ns
		-A10	14H	0	0	0	1	0	1	0	20 ns
28	trrd(MIN.)	-A80	10H	0	0	0	1	0	0	0	16 ns
		-A10	14H	0	0	0	1	0	1	0	20 ns
29	trcd(MIN.)	-A80	14H	0	0	0	1	0	1	0	20 ns
		-A10	14H	0	0	0	1	0	1	0	20 ns
30	tras(MIN.)	-A80	30H	0	0	1	1	0	0	0	48 ns
		-A10	32H	0	0	1	1	0	0	1	50 ns
31	Module bank density	10H	0	0	0	1	0	0	0	0	64M bytes

(2/2)

Byte No.	Function Described	Hex	Bit 7	Bit 6	Bit 5	Bit 4	Bit 3	Bit 2	Bit 1	Bit 0	Notes	
32	Command and address signal setup time	-A80	20H	0	0	1	0	0	0	0	2 ns	
		-A10	20H	0	0	1	0	0	0	0	2 ns	
33	Command and address signal hold time	-A80	10H	0	0	0	1	0	0	0	1 ns	
		-A10	10H	0	0	0	1	0	0	0	1 ns	
34	Data signal input setup time	-A80	20H	0	0	1	0	0	0	0	2 ns	
		-A10	20H	0	0	1	0	0	0	0	2 ns	
35	Data signal input hold time	-A80	10H	0	0	0	1	0	0	0	1 ns	
		-A10	10H	0	0	0	1	0	0	0	1 ns	
36-61		00H	0	0	0	0	0	0	0	0		
62	SPD revision	-A80	12H	0	0	0	1	0	0	1	0	1.2 A
		-A10	12H	0	0	0	1	0	0	1	0	1.2 A
63	Checksum for bytes 0 - 62	-A80	01H	0	0	0	0	0	0	0	1	
		-A10	67H	0	1	1	0	0	1	1	1	
64-71	Manufacture's JEDEC ID code											
72	Manufacturing location											
73-90	Manufacture's P/N											
91-92	Revision code											
93-94	Manufacturing date											
95-98	Assembly serial number											
99-125	Mfg specific											
126	Intel specification frequency	-A80	64H	0	1	1	0	0	1	0	0	100 MHz
		-A10	64H	0	1	1	0	0	1	0	0	100 MHz
127	Intel specification /CAS latency support	-A80	87H	1	0	0	0	0	1	1	1	
		-A10	85H	1	0	0	0	0	1	0	1	

Timing Chart

Refer to the **SYNCHRONOUS DRAM MODULE TIMING CHART Information (M13348E)**.

★ Package Drawing

144-PIN DUAL IN-LINE MODULE (SOCKET TYPE)

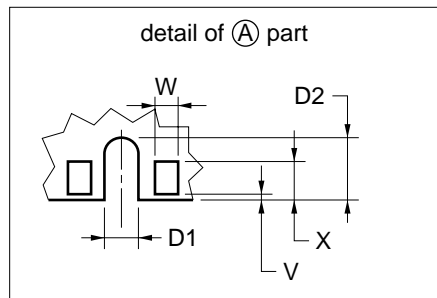
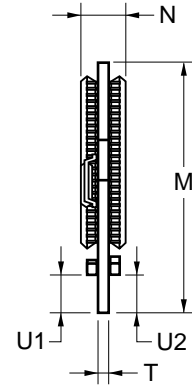
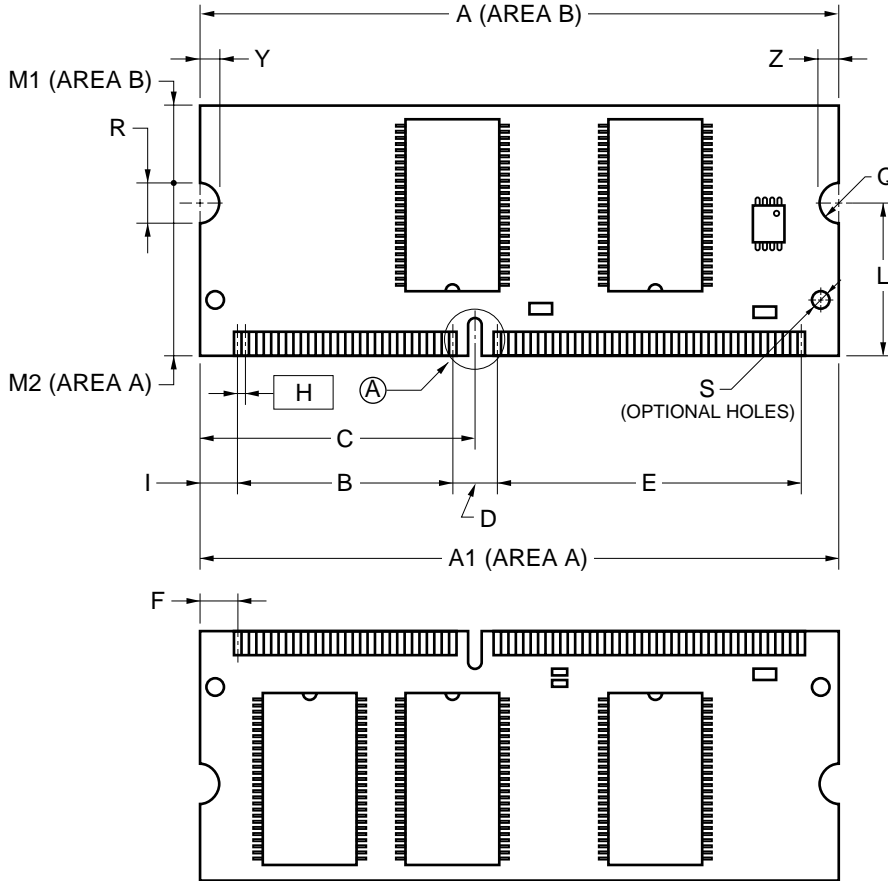

ITEM	MILLIMETERS
A	67.6
A1	67.6±0.15
B	23.2
C	29.0
D	4.6
D1	1.5±0.10
D2	4.0
E	32.8
F	3.7
H	0.8 (T.P.)
I	3.3
L	20.0
M	31.75±0.15
M1	9.75
M2	22.0
N	3.8 MAX.
Q	R2.0
R	4.00±0.10
S	∅ 1.8
T	1.0±0.1
U1	3.2 MIN.
U2	4.0 MIN.
V	0.25 MAX.
W	0.6±0.05
X	2.55 MIN.
Y	2.0 MIN.
Z	2.0 MIN.

M144S-80A13

[MEMO]

[MEMO]

NOTES FOR CMOS DEVICES**① PRECAUTION AGAINST ESD FOR SEMICONDUCTORS**

Note:

Strong electric field, when exposed to a MOS device, can cause destruction of the gate oxide and ultimately degrade the device operation. Steps must be taken to stop generation of static electricity as much as possible, and quickly dissipate it once, when it has occurred. Environmental control must be adequate. When it is dry, humidifier should be used. It is recommended to avoid using insulators that easily build static electricity. Semiconductor devices must be stored and transported in an anti-static container, static shielding bag or conductive material. All test and measurement tools including work bench and floor should be grounded. The operator should be grounded using wrist strap. Semiconductor devices must not be touched with bare hands. Similar precautions need to be taken for PW boards with semiconductor devices on it.

② HANDLING OF UNUSED INPUT PINS FOR CMOS

Note:

No connection for CMOS device inputs can be cause of malfunction. If no connection is provided to the input pins, it is possible that an internal input level may be generated due to noise, etc., hence causing malfunction. CMOS devices behave differently than Bipolar or NMOS devices. Input levels of CMOS devices must be fixed high or low by using a pull-up or pull-down circuitry. Each unused pin should be connected to V_{DD} or GND with a resistor, if it is considered to have a possibility of being an output pin. All handling related to the unused pins must be judged device by device and related specifications governing the devices.

③ STATUS BEFORE INITIALIZATION OF MOS DEVICES

Note:

Power-on does not necessarily define initial status of MOS device. Production process of MOS does not define the initial operation status of the device. Immediately after the power source is turned ON, the devices with reset function have not yet been initialized. Hence, power-on does not guarantee out-pin levels, I/O settings or contents of registers. Device is not initialized until the reset signal is received. Reset operation must be executed immediately after power-on for devices having reset function.

CAUTION FOR HANDLING MEMORY MODULES

When handling or inserting memory modules, be sure not to touch any components on the modules, such as the memory IC, chip capacitors and chip resistors. It is necessary to avoid undue mechanical stress on these components to prevent damaging them.

When re-packing memory modules, be sure the modules are NOT touching each other. Modules in contact with other modules may cause excessive mechanical stress, which may damage the modules.

- **The information in this document is subject to change without notice. Before using this document, please confirm that this is the latest version.**
 - No part of this document may be copied or reproduced in any form or by any means without the prior written consent of NEC Corporation. NEC Corporation assumes no responsibility for any errors which may appear in this document.
 - NEC Corporation does not assume any liability for infringement of patents, copyrights or other intellectual property rights of third parties by or arising from use of a device described herein or any other liability arising from use of such device. No license, either express, implied or otherwise, is granted under any patents, copyrights or other intellectual property rights of NEC Corporation or others.
 - Descriptions of circuits, software, and other related information in this document are provided for illustrative purposes in semiconductor product operation and application examples. The incorporation of these circuits, software, and information in the design of the customer's equipment shall be done under the full responsibility of the customer. NEC Corporation assumes no responsibility for any losses incurred by the customer or third parties arising from the use of these circuits, software, and information.
 - While NEC Corporation has been making continuous effort to enhance the reliability of its semiconductor devices, the possibility of defects cannot be eliminated entirely. To minimize risks of damage or injury to persons or property arising from a defect in an NEC semiconductor device, customers must incorporate sufficient safety measures in its design, such as redundancy, fire-containment, and anti-failure features.
 - NEC devices are classified into the following three quality grades:
"Standard", "Special", and "Specific". The Specific quality grade applies only to devices developed based on a customer designated "quality assurance program" for a specific application. The recommended applications of a device depend on its quality grade, as indicated below. Customers must check the quality grade of each device before using it in a particular application.
 - Standard: Computers, office equipment, communications equipment, test and measurement equipment, audio and visual equipment, home electronic appliances, machine tools, personal electronic equipment and industrial robots
 - Special: Transportation equipment (automobiles, trains, ships, etc.), traffic control systems, anti-disaster systems, anti-crime systems, safety equipment and medical equipment (not specifically designed for life support)
 - Specific: Aircraft, aerospace equipment, submersible repeaters, nuclear reactor control systems, life support systems or medical equipment for life support, etc.
- The quality grade of NEC devices is "Standard" unless otherwise specified in NEC's Data Sheets or Data Books. If customers intend to use NEC devices for applications other than those specified for Standard quality grade, they should contact an NEC sales representative in advance.