



Ultra-Small, Low-Cost, 210MHz, Single-Supply Op Amps with Rail-to-Rail Outputs

General Description

The MAX4450 single and MAX4451 dual op amps are unity-gain-stable devices that combine high-speed performance with Rail-to-Rail® outputs. Both devices operate from a +4.5V to +11V single supply or from $\pm 2.25V$ to $\pm 5.5V$ dual supplies. The common-mode input voltage range extends beyond the negative power-supply rail (ground in single-supply applications).

The MAX4450/MAX4451 require only 6.5mA of quiescent supply current per op amp while achieving a 210MHz -3dB bandwidth and a 485V/ μ s slew rate. Both devices are an excellent solution in low-power/low-voltage systems that require wide bandwidth, such as video, communications, and instrumentation.

The MAX4450 is available in the ultra-small 5-pin SC70 package, while the MAX4451 is available in a space-saving 8-pin SOT23.

Applications

Set-Top Boxes
Surveillance Video Systems
Battery-Powered Instruments
Video Line Driver
Analog-to-Digital Converter Interface
CCD Imaging Systems
Video Routing and Switching Systems
Digital Cameras

Typical Operating Circuit

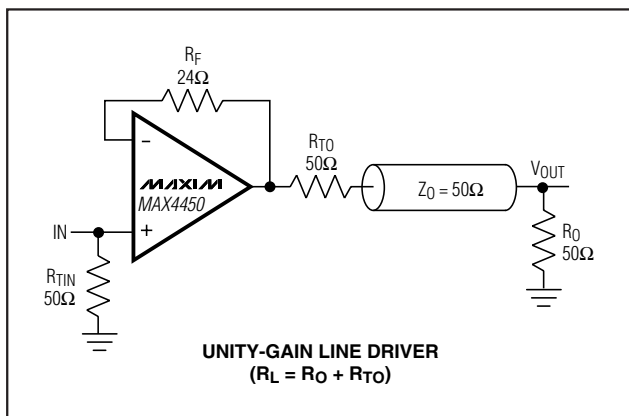

Rail-to-Rail is a registered trademark of Nippon Motorola, Ltd.

Features

- ◆ Ultra-Small SC70-5, SOT23-5, and SOT23-8 Packages
- ◆ Low Cost
- ◆ High Speed
 - 210MHz -3dB Bandwidth
 - 55MHz 0.1dB Gain Flatness
 - 485V/ μ s Slew Rate
- ◆ Single +4.5V to +11V Operation
- ◆ Rail-to-Rail Outputs
- ◆ Input Common-Mode Range Extends Beyond V_{EE}
- ◆ Low Differential Gain/Phase: 0.02%/0.08°
- ◆ Low Distortion at 5MHz
 - 65dBc SFDR
 - 63dB Total Harmonic Distortion

Ordering Information

PART	TEMP. RANGE	PIN-PACKAGE	TOP MARK
MAX4450EXK-T	-40°C to +85°C	5 SC70-5	AAA
MAX4450EUK-T	-40°C to +85°C	5 SOT23-5	ADKP
MAX4451EKA-T	-40°C to +85°C	8 SOT23-8	AAAA
MAX4451ESA	-40°C to +85°C	8 SO	—

Pin Configurations

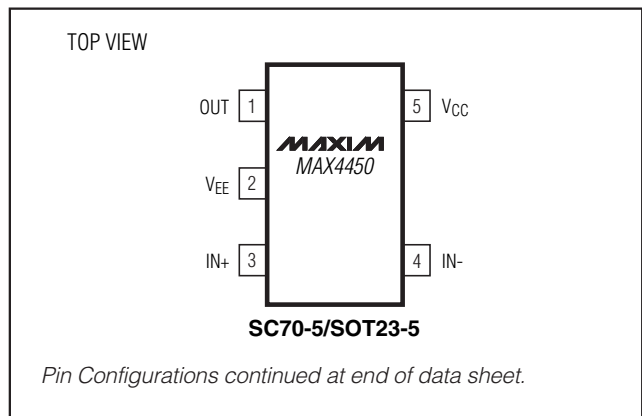

Ultra-Small, Low-Cost, 210MHz, Single-Supply Op Amps with Rail-to-Rail Outputs

MAX4445CUI/4445CUI

ABSOLUTE MAXIMUM RATINGS

Supply Voltage (V _{CC} to V _{EE}).....	+12V	8-Pin SOT23-8 (derate 5.26mW/°C above +70°C).....	421mW
IN ₋ , IN ₊ , OUT ₋	(V _{EE} - 0.3V) to (V _{CC} + 0.3V)	8-Pin SO (derate 5.9mW/°C above +70°C).....	471mW
Output Short-Circuit Current to V _{CC} or V _{EE}	150mA	Operating Temperature Range	-40°C to +85°C
Continuous Power Dissipation (T _A = +70°C)		Storage Temperature Range	-65°C to +150°C
5-Pin SC70-5 (derate 2.5mW/°C above +70°C).....	200mW	Lead Temperature (soldering, 10s).....	+300°C
5-Pin SOT23-5 (derate 7.1mW/°C above +70°C).....	571mW		

Stresses beyond those listed under "Absolute Maximum Ratings" may cause permanent damage to the device. These are stress ratings only, and functional operation of the device at these or at any other conditions beyond those indicated in the operational sections of the specifications is not implied. Exposure to absolute maximum rating conditions for extended periods may affect device reliability.

DC ELECTRICAL CHARACTERISTICS

(V_{CC} = +5V, V_{EE} = 0, R_L = ∞ to V_{CC}/2, V_{OUT} = V_{CC}/2, T_A = T_{MIN} to T_{MAX}, unless otherwise noted. Typical values are at T_A = +25°C.) (Note 1)

PARAMETER	SYMBOL	CONDITIONS		MIN	TYP	MAX	UNITS
Input Common-Mode Voltage Range	V _{CM}	Guaranteed by CMRR test		V _{EE} - 0.20		V _{CC} 2.25	V
Input Offset Voltage (Note 2)	V _{OS}				4	26	mV
Input Offset Voltage Matching					1.0		mV
Input Offset Voltage Temperature Coefficient	TC _{VOS}				8		µV/°C
Input Bias Current	I _B	(Note 2)			6.5	20	µA
Input Offset Current	I _{OS}	(Note 2)			0.5	4	µA
Input Resistance	R _{IN}	Differential mode (-1V ≤ V _{IN} ≤ +1V)			70		kΩ
		Common mode (-0.2V ≤ V _{CM} ≤ +2.75V)			3		MΩ
Common-Mode Rejection Ratio	CMRR	(V _{EE} - 0.2V) ≤ V _{CM} ≤ (V _{CC} - 2.25V)		70	95		dB
Open-Loop Gain (Note 2)	A _{VOL}	0.25V ≤ V _{OUT} ≤ 4.75V, R _L = 2kΩ		50	60		dB
		0.5V ≤ V _{OUT} ≤ 4.5V, R _L = 150Ω		48	58		
		1V ≤ V _{OUT} ≤ 4V, R _L = 50Ω			57		
Output Voltage Swing (Note 2)	V _{OUT}	R _L = 2kΩ	V _{CC} - V _{OH}	0.05	0.20	V	
			V _{OL} - V _{EE}	0.05	0.15		
		R _L = 150Ω	V _{CC} - V _{OH}	0.30	0.50		
			V _{OL} - V _{EE}	0.25	0.80		
		R _L = 75Ω	V _{CC} - V _{OH}	0.5	0.80		
			V _{OL} - V _{EE}	0.5	1.75		
R _L = 75Ω to ground	V _{CC} - V _{OH}	1.0	1.5				
	V _{OL} - V _{EE}	0.025	0.065				
Output Current	I _{OUT}	R _L = 50Ω	Sourcing	45	70	mA	
			Sinking	25	50		
Output Short-Circuit Current	I _{SC}	Sinking or sourcing			±120		mA
Open-Loop Output Resistance	R _{OUT}				8		Ω
Power-Supply Rejection Ratio (Note 3)	PSRR	V _{CC} = 5V	V _{EE} = 0, V _{CM} = 2V	46	62	dB	
			V _{EE} = -5V, V _{CM} = 0	54	69		
Operating Supply-Voltage Range	V _S	V _{CC} to V _{EE}		4.5		11.0	V
Quiescent Supply Current (per amplifier)	I _S				6.5	9.0	mA

Ultra-Small, Low-Cost, 210MHz, Single-Supply Op Amps with Rail-to-Rail Outputs

MAX4450/MAX4451

AC ELECTRICAL CHARACTERISTICS

($V_{CC} = +5V$, $V_{EE} = 0$, $V_{CM} = +2.5V$, $R_F = 24\Omega$, $R_L = 100\Omega$ to $V_{CC}/2$, $V_{OUT} = V_{CC}/2$, $A_{VCL} = +1V/V$, $T_A = +25^\circ C$, unless otherwise noted.)

PARAMETER	SYMBOL	CONDITIONS	MIN	TYP	MAX	UNITS
Small-Signal -3dB Bandwidth	BW _{SS}	$V_{OUT} = 100mVp-p$		210		MHz
Large-Signal -3dB Bandwidth	BW _{LS}	$V_{OUT} = 2Vp-p$		175		MHz
Bandwidth for 0.1dB Gain Flatness	BW _{0.1dB}	$V_{OUT} = 100mVp-p$		55		MHz
Slew Rate	SR	$V_{OUT} = 2V$ step		485		V/ μs
Settling Time to 0.1%	t_s	$V_{OUT} = 2V$ step		16		ns
Rise/Fall Time	t_R , t_F	$V_{OUT} = 100mVp-p$		4		ns
Spurious-Free Dynamic Range	SFDR	$f_C = 5MHz$, $V_{OUT} = 2Vp-p$		-65		dBc
Harmonic Distortion	HD	$f_C = 5MHz$, $V_{OUT} = 2Vp-p$	2nd harmonic	-65		dBc
			3rd harmonic	-58		
			Total harmonic distortion	-63		
Two-Tone, Third-Order Intermodulation Distortion	IP3	$f_1 = 4.7MHz$, $f_2 = 4.8MHz$, $V_{OUT} = 1Vp-p$		66		dBc
Channel-to-Channel Isolation	CH _{ISO}	Specified at DC		102		dB
Input 1dB Compression Point		$f_C = 10MHz$, $A_{VCL} = +2V/V$		14		dBm
Differential Phase Error	DP	NTSC, $R_L = 150\Omega$		0.08		degrees
Differential Gain Error	DG	NTSC, $R_L = 150\Omega$		0.02		%
Input Noise-Voltage Density	e_n	$f = 10kHz$		10		nV/ \sqrt{Hz}
Input Noise-Current Density	i_n	$f = 10kHz$		1.8		pA/ \sqrt{Hz}
Input Capacitance	C_{IN}			1		pF
Output Impedance	Z_{OUT}	$f = 10MHz$		1.5		Ω

Note 1: All devices are 100% production tested at $T_A = +25^\circ C$. Specifications over temperature limits are guaranteed by design.

Note 2: Tested with $V_{CM} = +2.5V$.

Note 3: PSR for single +5V supply tested with $V_{EE} = 0$, $V_{CC} = +4.5V$ to $+5.5V$; PSR for dual $\pm 5V$ supply tested with $V_{EE} = -4.5V$ to $-5.5V$, $V_{CC} = +4.5V$ to $+5.5V$.

Ultra-Small, Low-Cost, 210MHz, Single-Supply Op Amps with Rail-to-Rail Outputs

Typical Operating Characteristics

($V_{CC} = +5V$, $V_{EE} = 0$, $V_{CM} = +2.5V$, $A_{VCL} = +1V/V$, $R_F = 24\Omega$, $R_L = 100\Omega$ to $V_{CC}/2$, $T_A = +25^\circ C$, unless otherwise noted.)

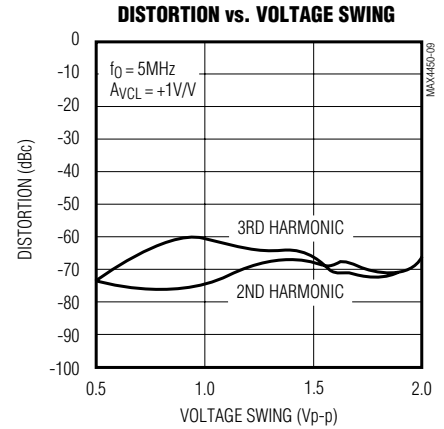
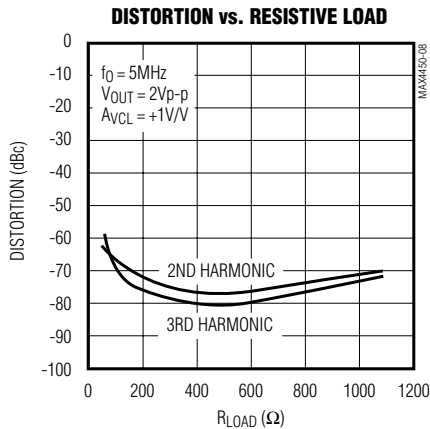
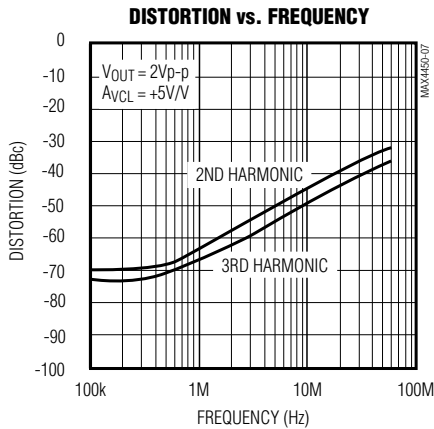
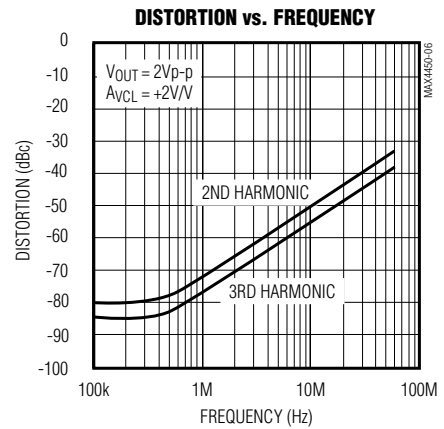
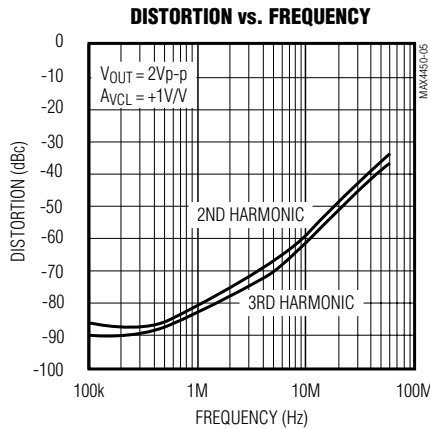
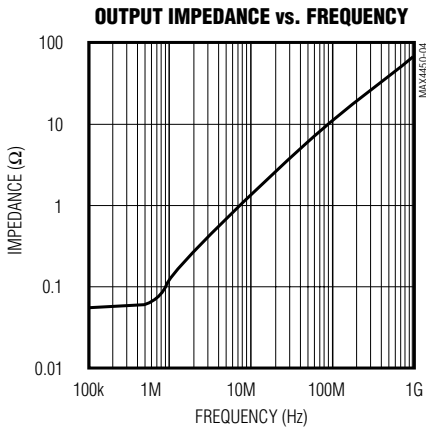
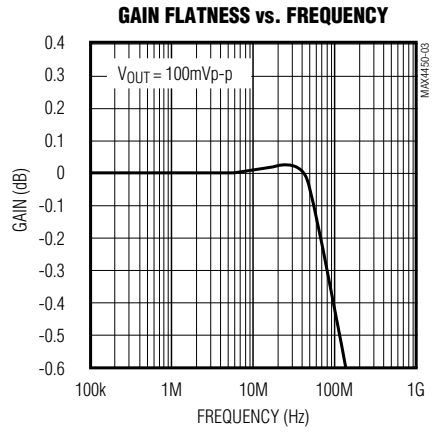
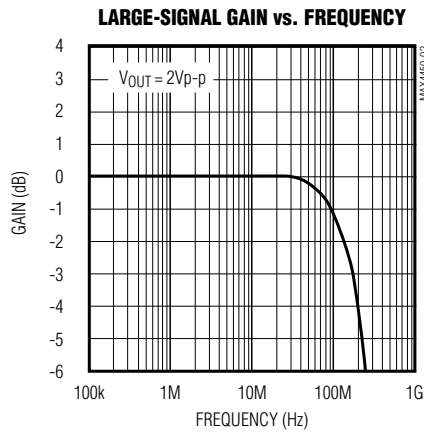
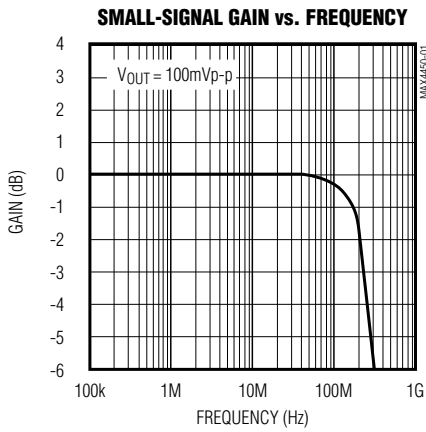

Ultra-Small, Low-Cost, 210MHz, Single-Supply Op Amps with Rail-to-Rail Outputs

MAX4450/MAX4451

Typical Operating Characteristics (continued)

($V_{CC} = +5V$, $V_{EE} = 0$, $V_{CM} = +2.5V$, $A_{VCL} = +1V/V$, $R_F = 24\Omega$, $R_L = 100\Omega$ to $V_{CC}/2$, $T_A = +25^\circ C$, unless otherwise noted.)

DIFFERENTIAL GAIN AND PHASE

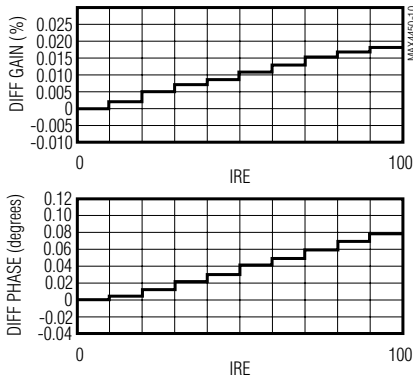

COMMON-MODE REJECTION vs. FREQUENCY

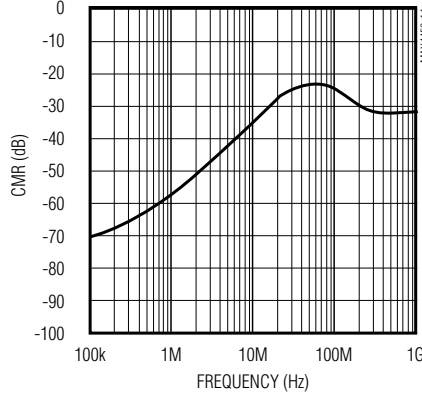

POWER-SUPPLY REJECTION vs. FREQUENCY

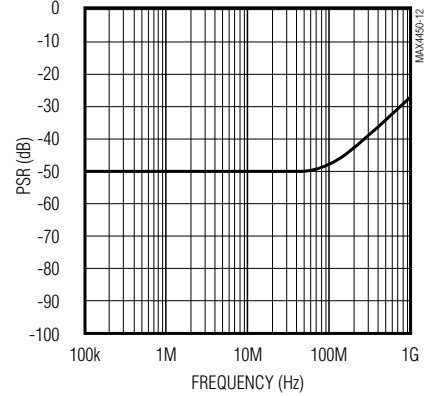

OUTPUT VOLTAGE SWING vs. RESISTIVE LOAD

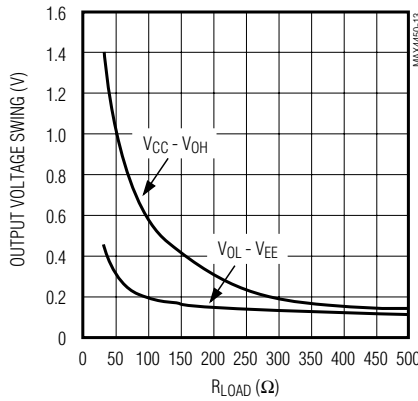

SMALL-SIGNAL PULSE RESPONSE

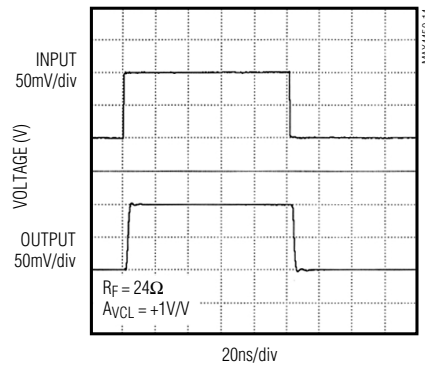

SMALL-SIGNAL PULSE RESPONSE

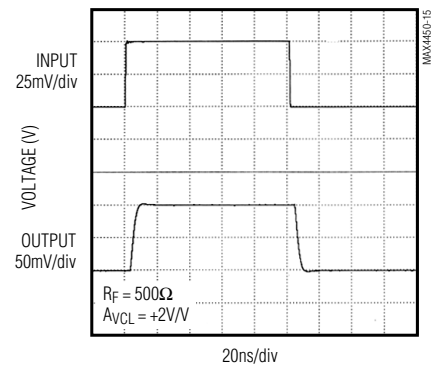

SMALL-SIGNAL PULSE RESPONSE

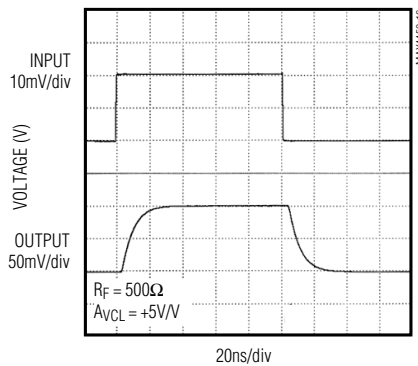

LARGE-SIGNAL PULSE RESPONSE

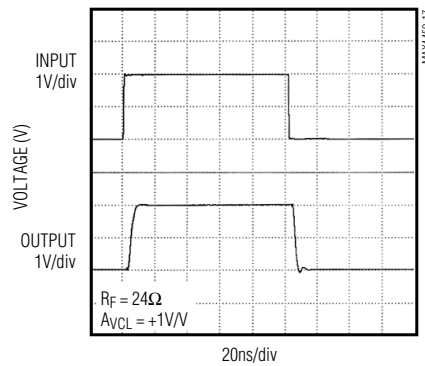

LARGE-SIGNAL PULSE RESPONSE

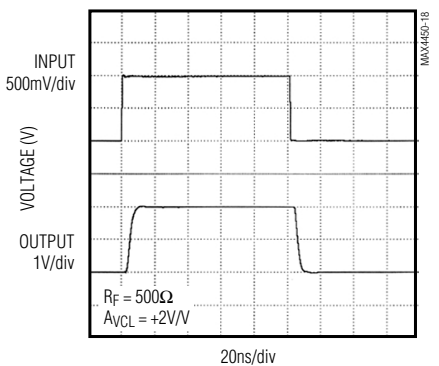

Ultra-Small, Low-Cost, 210MHz, Single-Supply Op Amps with Rail-to-Rail Outputs

Typical Operating Characteristics (continued)

($V_{CC} = +5V$, $V_{EE} = 0$, $V_{CM} = +2.5V$, $A_{VCL} = +1V/V$, $R_F = 24\Omega$, $R_L = 100\Omega$ to $V_{CC}/2$, $T_A = +25^\circ C$, unless otherwise noted.)

LARGE-SIGNAL PULSE RESPONSE

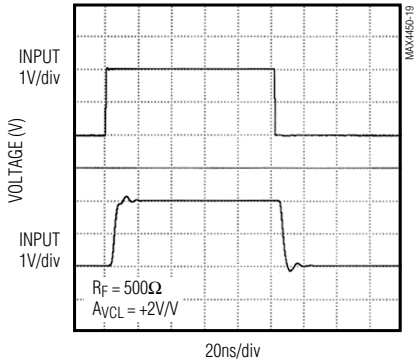

VOLTAGE NOISE vs. FREQUENCY

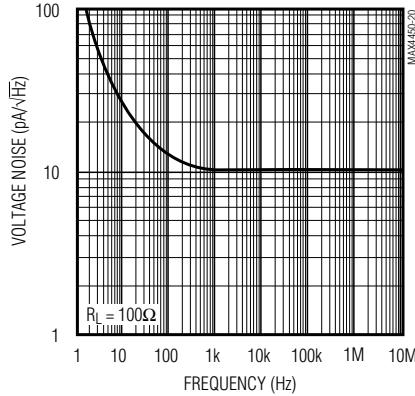

CURRENT NOISE vs. FREQUENCY

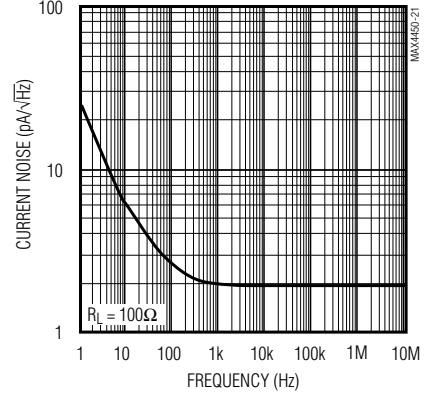

ISOLATION RESISTANCE vs. CAPACITIVE LOAD

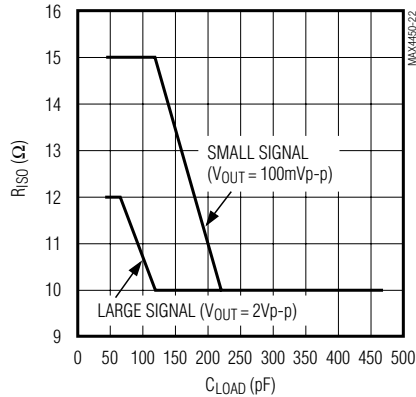

SMALL-SIGNAL BANDWIDTH vs. LOAD RESISTANCE

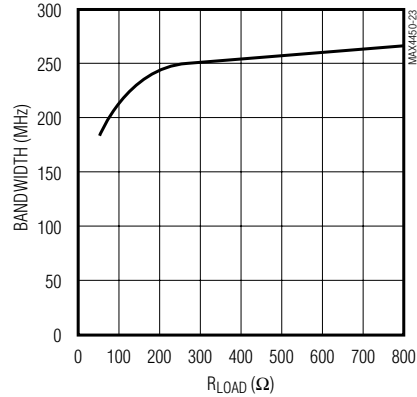

OPEN-LOOP GAIN vs. RESISTIVE LOAD

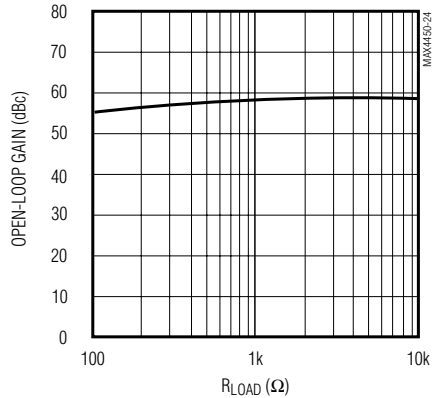

MAX4451 CROSSTALK vs. FREQUENCY

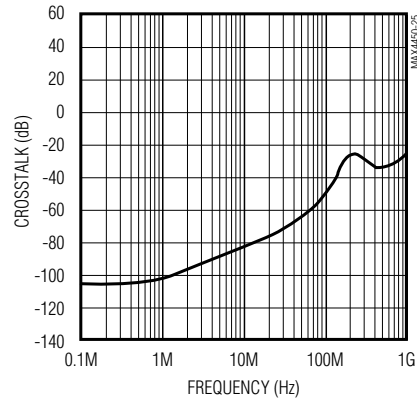

Ultra-Small, Low-Cost, 210MHz, Single-Supply Op Amps with Rail-to-Rail Outputs

MAX4450/MAX4451

Pin Description

PIN		NAME	FUNCTION
MAX4450	MAX4451		
1	—	OUT	Amplifier Output
2	4	VEE	Negative Power Supply or Ground (in single-supply operation)
3	—	IN+	Noninverting Input
4	—	IN-	Inverting Input
5	8	VCC	Positive Power Supply
—	1	OUTA	Amplifier A Output
—	2	INA-	Amplifier A Inverting Input
—	3	INA+	Amplifier A Noninverting Input
—	7	OUTB	Amplifier B Output
—	6	INB-	Amplifier B Inverting Input
—	5	INB+	Amplifier B Noninverting Input

Detailed Description

The MAX4450/MAX4451 are single-supply, rail-to-rail, voltage-feedback amplifiers that employ current-feedback techniques to achieve 485V/μs slew rates and 210MHz bandwidths. Excellent harmonic distortion and differential gain/phase performance make these amplifiers an ideal choice for a wide variety of video and RF signal-processing applications.

The output voltage swings to within 55mV of each supply rail. Local feedback around the output stage ensures low open-loop output impedance to reduce gain sensitivity to load variations. The input stage permits common-mode voltages beyond the negative supply and to within 2.25V of the positive supply rail.

Applications Information

Choosing Resistor Values

Unity-Gain Configuration

The MAX4450/MAX4451 are internally compensated for unity gain. When configured for unity gain, the devices require a 24Ω resistor (R_F) in series with the feedback path. This resistor improves AC response by reducing the Q of the parallel LC circuit formed by the parasitic feedback capacitance and inductance.

Inverting and Noninverting Configurations

Select the gain-setting feedback (R_F) and input (R_G) resistor values to fit your application. Large resistor values increase voltage noise and interact with the amplifier's input and PC board capacitance. This can generate undesirable poles and zeros and decrease bandwidth or cause oscillations. For example, a noninverting gain-of-two configuration (R_F = R_G) using 1kΩ resistors, combined with 1pF of amplifier input capacitance and 1pF of PC board capacitance, causes a pole at 159MHz. Since this pole is within the amplifier bandwidth, it jeopardizes stability. Reducing the 1kΩ resistors to 100Ω extends the pole frequency to 1.59GHz, but could limit output swing by adding 200Ω in parallel with the amplifier's load resistor. Table 1 lists suggested feedback and gain resistors, and bandwidths for several gain values in the configurations shown in Figures 1a and 1b.

Layout and Power-Supply Bypassing

These amplifiers operate from a single +4.5V to +11V power supply or from dual ±2.25V to ±5.5V supplies. For single-supply operation, bypass VCC to ground with a

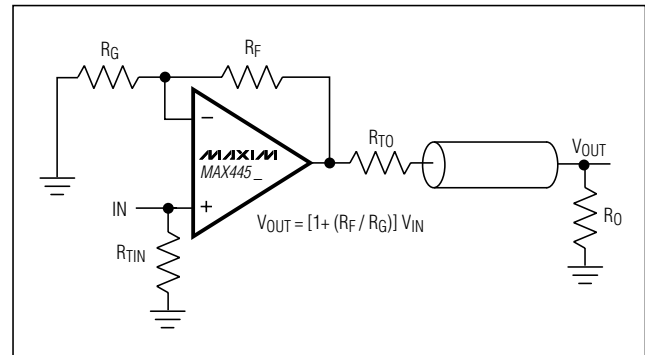

Figure 1a. Noninverting Gain Configuration

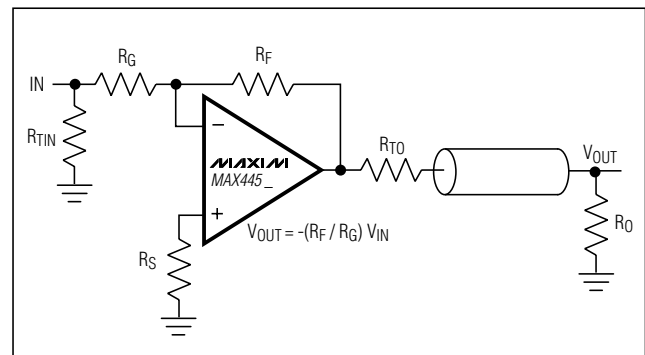

Figure 1b. Inverting Gain Configuration

Ultra-Small, Low-Cost, 210MHz, Single-Supply Op Amps with Rail-to-Rail Outputs

Table 1. Recommended Component Values

COMPONENT	GAIN (V/V)									
	+1	-1	+2	-2	+5	-5	+10	-10	+25	-25
R _F (Ω)	24	500	500	500	500	500	500	500	500	1200
R _G (Ω)	∞	500	500	250	124	100	56	50	20	50
R _S (Ω)	—	0	—	0	—	0	—	0	—	0
R _{TIN} (Ω)	49.9	56	49.9	62	49.9	100	49.9	∞	49.9	∞
R _{TO} (Ω)	49.9	49.9	49.9	49.9	49.9	49.9	49.9	49.9	49.9	49.9
Small-Signal -3dB Bandwidth (MHz)	210	100	95	50	25	25	11	15	5	10

Note: $R_L = R_O + R_{TO}$; R_{TIN} and R_{TO} are calculated for 50Ω applications. For 75Ω systems, $R_{TO} = 75Ω$; calculate R_{TIN} from the following equation:

$$R_{TIN} = \frac{75}{1 - \frac{75}{R_G}} \Omega$$

0.1μF capacitor as close to the pin as possible. If operating with dual supplies, bypass each supply with a 0.1μF capacitor.

Maxim recommends using microstrip and stripline techniques to obtain full bandwidth. To ensure that the PC board does not degrade the amplifier's performance, design it for a frequency greater than 1GHz. Pay careful attention to inputs and outputs to avoid large parasitic capacitance. Whether or not you use a constant-impedance board, observe the following design guidelines:

- Don't use wire-wrap boards; they are too inductive.
- Don't use IC sockets; they increase parasitic capacitance and inductance.
- Use surface-mount instead of through-hole components for better high-frequency performance.
- Use a PC board with at least two layers; it should be as free from voids as possible.
- Keep signal lines as short and as straight as possible. Do not make 90° turns; round all corners.

Rail-to-Rail Outputs, Ground-Sensing Input

The input common-mode range extends from ($V_{EE} - 200mV$) to ($V_{CC} - 2.25V$) with excellent common-mode rejection. Beyond this range, the amplifier output is a nonlinear function of the input, but does not undergo phase reversal or latchup.

The output swings to within 55mV of either power-supply rail with a 2kΩ load. The input ground sensing

and the rail-to-rail output substantially increase the dynamic range. With a symmetric input in a single +5V application, the input can swing 2.95Vp-p and the output can swing 4.9Vp-p with minimal distortion.

Output Capacitive Loading and Stability

The MAX4450/MAX4451 are optimized for AC performance. They are not designed to drive highly reactive loads, which decrease phase margin and may produce excessive ringing and oscillation. Figure 2 shows a circuit that eliminates this problem. Figure 3 is a graph of the optimal isolation resistor (R_S) vs. capacitive load. Figure 4 shows how a capacitive load causes excessive peaking of the amplifier's frequency response if the capacitor is not isolated from the amplifier by a resistor. A small isolation resistor (usually 20Ω to 30Ω) placed before the reactive load prevents ringing and oscillation. At higher capacitive loads, AC performance is controlled by the interaction of the load capacitance and the isolation resistor. Figure 5 shows the effect of a 27Ω isolation resistor on closed-loop response.

Coaxial cable and other transmission lines are easily driven when properly terminated at both ends with their characteristic impedance. Driving back-terminated transmission lines essentially eliminates the line's capacitance.

Ultra-Small, Low-Cost, 210MHz, Single-Supply Op Amps with Rail-to-Rail Outputs

MAX4450/MAX4451

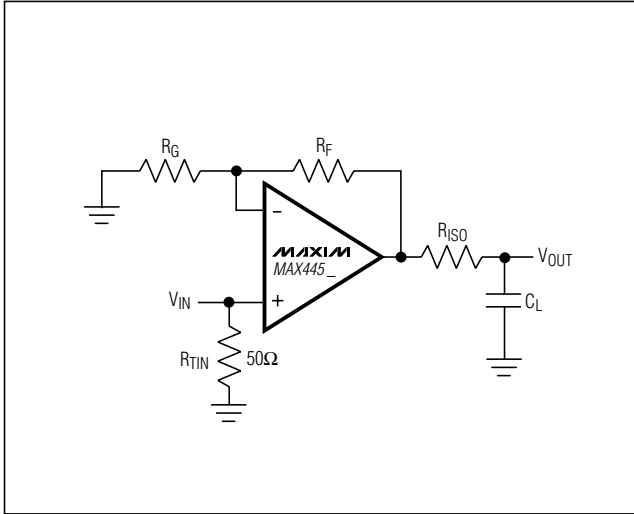

Figure 2. Driving a Capacitive Load Through an Isolation Resistor

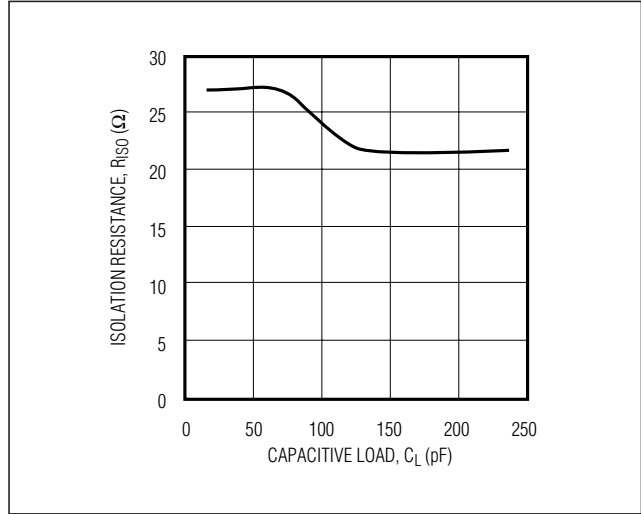

Figure 3. Capacitive Load vs. Isolation Resistance

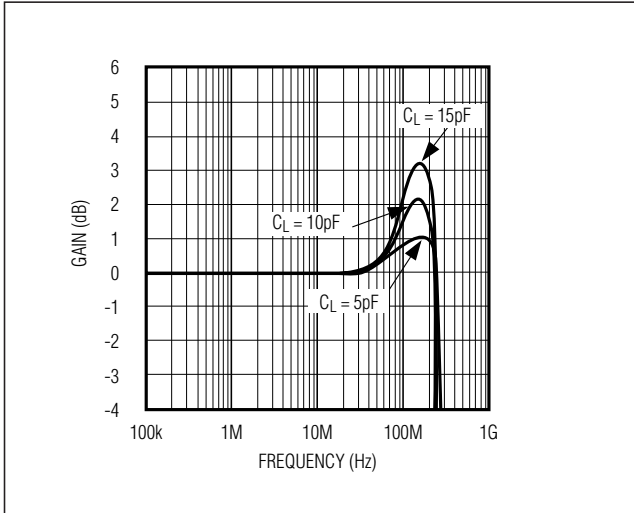

Figure 4. Small-Signal Gain vs. Frequency with Load Capacitance and No Isolation Resistor

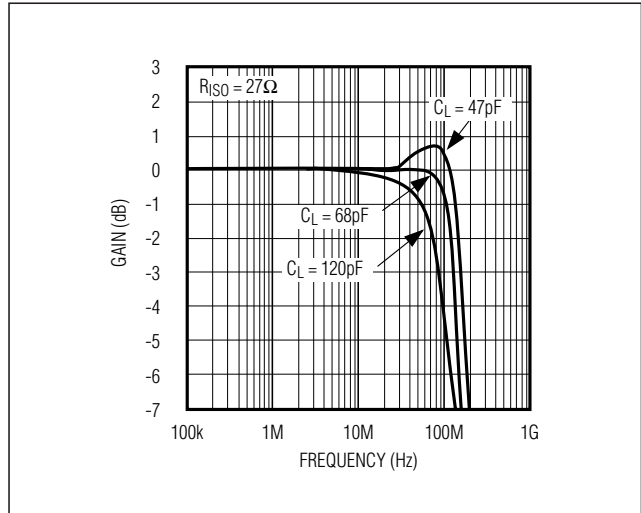

Figure 5. Small-Signal Gain vs. Frequency with Load Capacitance and 27Ω Isolation Resistor

Ultra-Small, Low-Cost, 210MHz, Single-Supply Op Amps with Rail-to-Rail Outputs

MAX4450/MAX4451

Pin Configurations (continued)

Chip Information

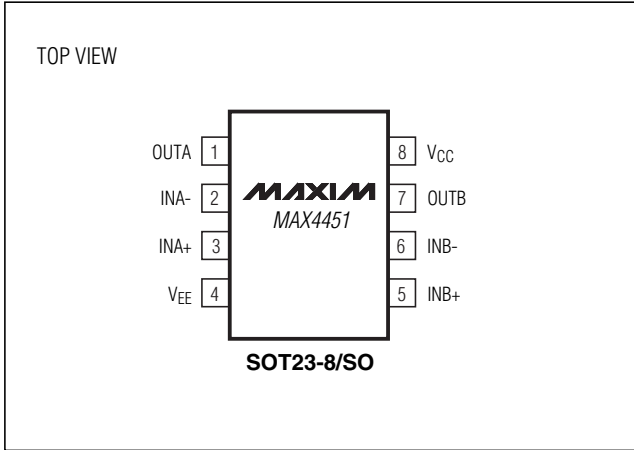

MAX4450 TRANSISTOR COUNT: 86

MAX4451 TRANSISTOR COUNT: 170

Ultra-Small, Low-Cost, 210MHz, Single-Supply Op Amps with Rail-to-Rail Outputs

Package Information

MAX4450/MAX4451

SYMBOL	MIN	MAX
e	0.65	BSC
D	1.80	2.20
b	0.15	0.30
E	1.15	1.35
HE	1.80	2.40
Q1	0.10	0.40
A2	0.80	1.00
A1	0.00	0.10
A	0.80	1.10
c	0.10	0.18
L	0.10	0.30
L1	0.425	TYP.

NOTE:

1. ALL DIMENSIONS ARE IN MILLIMETERS
2. DIMENSIONS ARE INCLUSIVE OF PLATING
3. DIMENSIONS ARE EXCLUSIVE OF MOLD FLASH & METAL BURR
4. ALL SPECIFICATIONS COMPLY TO EIAJ SC70
5. COPLANARITY 4 MILS. MAX.

SC70, 5LEPS

MAXIM
PROPRIETARY INFORMATION

TITLE: PACKAGE OUTLINE, SC70, 5L

APPROVAL	DOCUMENT CONTROL NO	REV	1/1
	21-0076	B	

SYMBOL	MIN	MAX
A	0.90	1.45
A1	0.00	0.15
A2	0.90	1.30
b	0.35	0.50
c	0.08	0.20
D	2.80	3.00
E	2.60	3.00
E1	1.50	1.75
L	0.35	0.55
e	0.95	REF
e1	1.90	REF
a	0°	10°

NOTE:

1. ALL DIMENSIONS ARE IN MILLIMETERS.
2. FOOT LENGTH MEASURED AT INTERCEPT POINT BETWEEN DATUM A & LEAD SURFACE.
3. PACKAGE OUTLINE EXCLUSIVE OF MOLD FLASH & METAL BURR.
4. PACKAGE OUTLINE INCLUSIVE OF SOLDER PLATING.

SOT23, 5L

MAXIM
PROPRIETARY INFORMATION

TITLE: PACKAGE OUTLINE, SOT23, 5L

APPROVAL	DOCUMENT CONTROL NO	REV	1/1
	21-0057	B	

Ultra-Small, Low-Cost, 210MHz, Single-Supply Op Amps with Rail-to-Rail Outputs

Package Information (continued)

SYMBOL	MIN	MAX
A	0.90	1.45
A1	0.00	0.15
A2	0.90	1.30
b	0.28	0.45
c	0.09	0.20
D	2.80	3.00
E	2.60	3.00
E1	1.50	1.75
L	0.10	0.60
e	0.65 ref	
e1	1.95 ref	
α	0°	10°

NOTE:
 1. ALL DIMENSIONS ARE IN MILLIMETERS.
 2. FOOT LENGTH MEASURED REFERENCE TO FLAT FOOT SURFACE PARALLEL TO DATUM "A".
 3. PACKAGE OUTLINE EXCLUSIVE OF MOLD FLASH & METAL BURR.
 4. PACKAGE OUTLINE INCLUSIVE OF SOLDER PLATING.
 5. EIAJ REF. NUMBER SC-74 (6 LEAD VERSION)
 6. COPLANARITY 4 MILS. MAX.
 7. PIN 1 I.D. DOT IS 0.3 MM Ø MIN. LOCATED ABOVE PIN 1.

MAXIM
 PROPRIETARY INFORMATION
 TITLE: PACKAGE OUTLINE, SOT 23, 8L
 APPROVAL: DOCUMENT CONTROL NO. 21-0078 REV. B 1/1

INCHES		MILLIMETERS	
MIN	MAX	MIN	MAX
A	0.053	0.069	1.35
A1	0.004	0.010	0.10
B	0.014	0.019	0.35
C	0.007	0.010	0.19
e	0.050		1.27
E	0.150	0.157	3.80
H	0.228	0.244	5.80
h	0.010	0.020	0.25
L	0.016	0.050	0.40

INCHES		MILLIMETERS		N	MS012
MIN	MAX	MIN	MAX		
D	0.189	0.197	4.80	8	A
D	0.337	0.344	8.55	14	B
D	0.386	0.394	9.80	16	C

NOTES:
 1. D&E DO NOT INCLUDE MOLD FLASH
 2. MOLD FLASH OR PROTRUSIONS NOT TO EXCEED 15µm (0.001")
 3. LEADS TO BE COPLANAR WITHIN .102mm (.004")
 4. CONTROLLING DIMENSION: MILLIMETER
 5. MEETS JEDEC MS012-XX AS SHOWN IN ABOVE TABLE
 6. N = NUMBER OF PINS

MAXIM
 PROPRIETARY INFORMATION
 TITLE: PACKAGE FAMILY OUTLINE: SOIC .150° 1/1 21-0041 A
 APPROVAL: DOCUMENT CONTROL NO. REV. B

Maxim cannot assume responsibility for use of any circuitry other than circuitry entirely embodied in a Maxim product. No circuit patent licenses are implied. Maxim reserves the right to change the circuitry and specifications without notice at any time.

12 Maxim Integrated Products, 120 San Gabriel Drive, Sunnyvale, CA 94086 408-737-7600