



# Low Cost MMIC Mixer with Local Oscillator Amplifier, 0.8 GHz - 1.0 GHz



## Features

- -5 to +5 dBm LO Drive Level
- High Isolation, 28 dB LO to RF
- Inexpensive SOT-26 Package

## Description

The MD57-0001 is a floating FET mixer with an on-chip LO amplifier. The LO drive for the MD57-0001 can range from -5 to +5 dBm without severely impacting the mixer's performance. The MD57-0001 is ideally suited for cellular band communications handsets' that can provide only minimal amounts of LO drive. Typical applications include frequency up/down conversion and IQ modulation and demodulation in digital receivers and transmitters.

The MD57-0001 utilizes a patented "floating-FET" architecture. The on-chip LO amplifier allows the MD57-0001 to operate with as little as -5 dBm of LO drive making it an ideal choice for low power portable designs.

The MD57-0001 is fabricated using M/A-COM's 0.5 micron low noise GaAs MESFET process. This process features full passivation for increased performance and reliability. The MD57-0001 is 100% RF tested to ensure superior performance specification compliance.

## SOT-26

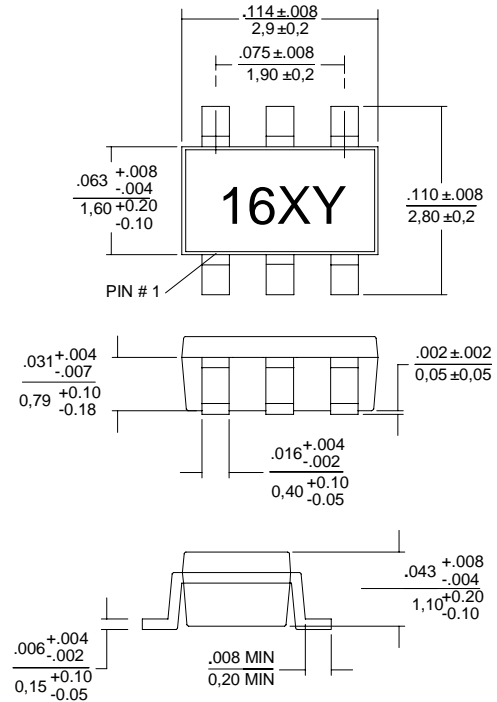

## Ordering Information

Part Number	Package
MD57-0001	SOT-26, 6-Lead Plastic Package
MD57-0001TR	Forward Tape and Reel*
MD57-0001SMB	Designer's Kit

\*If a specific reel size is required, consult factory for part number.

## Electrical Specifications<sup>1</sup>

T<sub>A</sub> = +25°C, RF = 900MHz (-15 dBm), LO = 730MHz (-5 dBm), IF = 170MHz, V<sub>DD</sub> = 2.7V, Typical I<sub>DD</sub> = 5mA

Parameters	Abbv.	Test Conditions	Units	Min.	Typ.	Max.
Conversion Loss	L <sub>c</sub>	—	dB	—	9.3	11
Isolation	ISO	LO to RF	dB	20	28	—
		LO to IF	dB	10	12	—
		RF to IF	dB	—	20	—
VSWR	VSWR	RF Port	—	—	2.0:1	—
		LO Port	—	—	2.0:1	—
		IF Port	—	—	2.0:1	—
Input 1 dB Compression	P <sub>1dB</sub>	RF Freq. = 900 MHz, LO = -5 dBm	dBm	—	14	—
Two Tone IM Ratio <sup>1</sup>	dBc	Two tones at -10 dBm each; Tone spacing = 1 MHz, IF = 170 MHz	dBc	—	59	—

1. IMR vs. RF drive can be calculated by the formula: IMR = [44 - 1.5(P<sub>IN</sub>)]

V2.00



### Absolute Maximum Ratings<sup>1,3</sup>

Parameter	Ratings
Input RF/IF Power <sup>2</sup>	+27 dBm
Input LO Power <sup>2</sup>	+17 dBm
Operating Voltages <sup>2</sup>	V <sub>DD</sub> = +6 volts
Operating Temperature	-30°C to +80°C
Storage Temperature	-65°C to +150°C

- Exceeding these limits may cause permanent damage.
- Ambient Temperature (T<sub>A</sub>) = + 25°C.
- Typical Thermal Resistance (θ<sub>JC</sub>) = 108°C/W at nominal bias condition.

### Functional Block Diagram

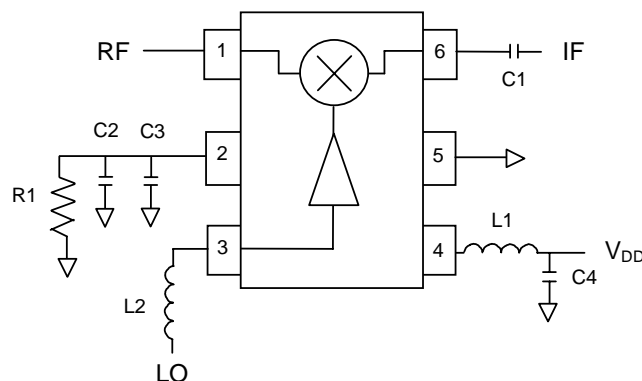

### Pin Configuration

Pin No.	Pin Name	Description
1	RF Port	RF Input/Output
2	Bias	LO Amplifier Bias Resistor
3	LO Port	LO Input
4	V <sub>DD</sub>	LO Amplifier V <sub>DD</sub>
5	GND	Ground
6	IF Port	IF Input/Output

### External Circuitry Parts List

Part Name	Description	Value
R1	LO Amplifier Bias Resistor	200 Ω
L1	LO Amplifier Bias Input	22 nH
L2	LO Port Matching	10 nH
C1	IF Port Matching	10 nF
C2	IF Bypass Capacitor	10 nF
C3	RF Bypass Capacitor	22 pF
C4	V <sub>DD</sub> Bypass	47 pF

### Recommended PCB Configuration

#### Layout View

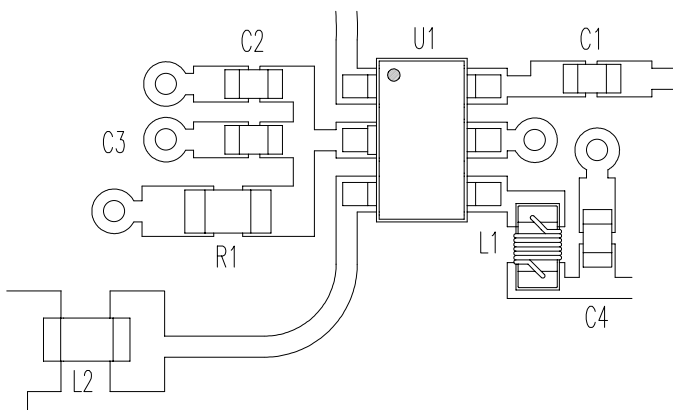

#### Cross Section View

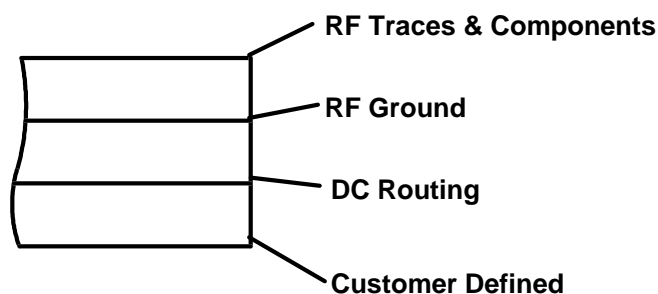

The PCB dielectric between RF traces and RF ground layers should be chosen to reduce RF discontinuities between 50 Ω lines and package pins. M/A-COM recommends an FR-4 dielectric thickness of 0.008" (0.2 mm) yielding a 50 Ω line width of 0.015" (0.38 mm). The recommended metalization thickness is 1 oz. Copper.

### Spurious Table (dBc)

LO Harmonic (n)		RF Harmonic (m)				
		0X	1X	2X	3X	4X
0X	-10 dBm	X	4.1	44.9	69.5	79.7
	0 dBm	X	3.9	31.9	48.4	70.0
1X	-10 dBm	13.8	0	47.6	82.0	76.6
	0 dBm	22.9	0	35.1	73.0	83.8
2X	-10 dBm	10.8	18.9	46.5	70.6	78.0
	0 dBm	20.4	18.9	36.6	55.9	84.0
3X	-10 dBm	12.1	23.8	41.5	76.9	77.1
	0 dBm	22.7	23.8	31.0	63.1	74.0
4X	-10 dBm	13.6	50.9	68.5	64.5	80.6
	0 dBm	24.0	49.4	58.9	45.4	63.4

- The spurious table shows the spurious signals resulting from the mixing of the RF and LO input signals assuming down conversion.
- Mixing products are indicated relative to the IF level.
- The lower frequency mixing term is shown for two different RF input levels.
- The RF frequency is 900 MHz, the LO frequency is 730 MHz.

$[nF_{RF} - mF_{LO}]$	RF = -10 dBm
$[nF_{RF} - mF_{LO}]$	RF = 0 dBm

### Typical Performance Data

- **Down Converter Application Test Conditions:** RF=900 MHz, IF=170 MHz, LO=730 MHz (LO Power = -5dBm)

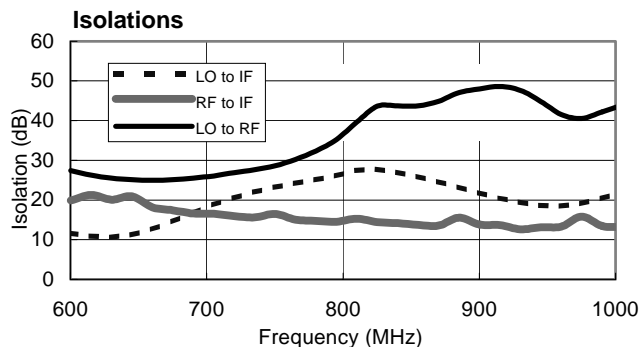
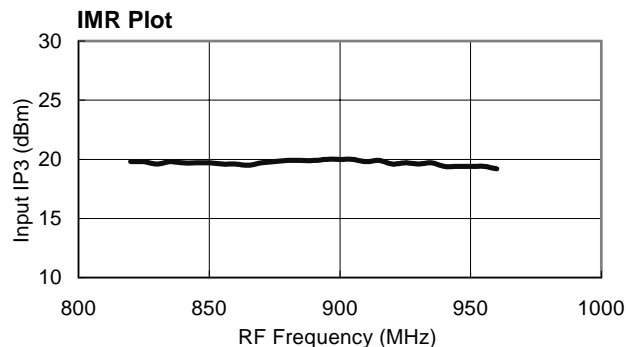
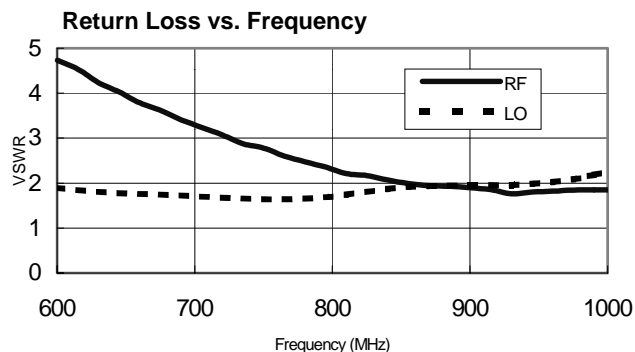
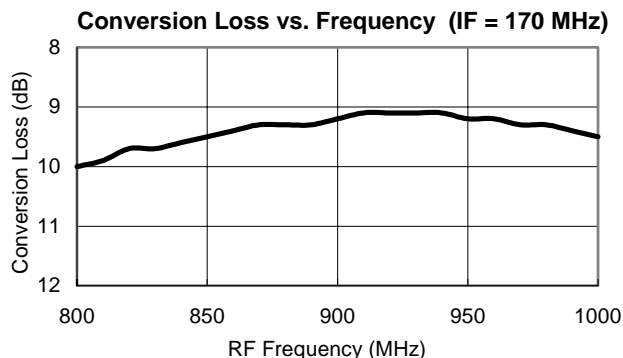

### Designer's Kit MD57-0001SMB

The MD57-0001SMB Designer's Kit allows for immediate evaluation of M/A-COM's MD57-0001. The Designer's Kit consists of an MD57-0001, an evaluation board, a floppy disk containing typical performance data and a DXF file of the recommended PCB layout. The evaluation board consists of the recommended external surface mount circuitry and RF connectors mounted to a multi-layer PCB. The MD57-0001SMB evaluation PCB is shown below with all functional ports labeled.

### Evaluation PCB and RF Connector Losses

Port Reference	Approximate RF Loss
RF Port	0.14 dB @ 900 MHz
LO Port	0.14 dB @ 730 MHz
IF Port	0.04 dB @ 170 MHz

### MD57-0001SMB Evaluation PCB

