

# Dual Series Schottky Barrier Diodes

These Schottky barrier diodes are designed for high speed switching applications, circuit protection, and voltage clamping. Extremely low forward voltage reduces conduction loss. Miniature surface mount package is excellent for hand held and portable applications where space is limited.

- Extremely Fast Switching Speed
- Low Forward Voltage — 0.35 Volts (Typ) @  $I_F = 10$  mAdc

## ORDERING INFORMATION

Device	Package	Shipping
LBAT54CLT1	SOT-23	3000/Tape & Reel

**Preferred:** devices are recommended choices for future use and best overall value.

## LBAT54CLT1

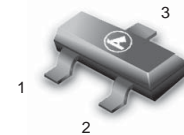

SOT-23

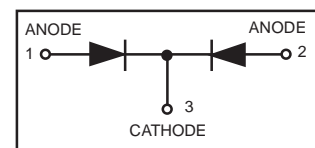

## DEVICE MARKING

LBAT54CLT1 = KL3

## MAXIMUM RATINGS ( $T_J = 125^\circ\text{C}$ unless otherwise noted)

Rating	Symbol	Value	Unit
Reverse Voltage	$V_R$	30	Volts
Forward Power Dissipation @ $T_A = 25^\circ\text{C}$	$P_F$	225	mW
Derate above $25^\circ\text{C}$		1.8	mW/ $^\circ\text{C}$
Forward Current(DC)	$I_F$	200Max	mA
Junction Temperature	$T_J$	125Max	$^\circ\text{C}$
Storage Temperature Range	$T_{stg}$	-55 to +150	$^\circ\text{C}$

## ELECTRICAL CHARACTERISTICS ( $T_A = 25^\circ\text{C}$ unless otherwise noted)

Characteristic	Symbol	Min	Typ	Max	Unit
Reverse Breakdown Voltage ( $I_R = 10 \mu\text{A}$ )	$V_{(BR)R}$	30	—	—	Volts
Total Capacitance ( $V_R = 1.0 \text{ V}$ , $f = 1.0 \text{ MHz}$ )	$C_T$	—	7.6	10	pF
Reverse Leakage ( $V_R = 25 \text{ V}$ )	$I_R$	—	0.5	2.0	$\mu\text{Adc}$
Forward Voltage ( $I_F = 0.1 \text{ mAdc}$ )	$V_F$	—	0.22	0.24	Vdc
Forward Voltage ( $I_F = 30 \text{ mAdc}$ )	$V_F$	—	0.41	0.5	Vdc
Forward Voltage ( $I_F = 100 \text{ mAdc}$ )	$V_F$	—	0.52	0.8	Vdc
Reverse Recovery Time ( $I_F = I_R = 10 \text{ mAdc}$ , $I_{R(REC)} = 1.0 \text{ mAdc}$ , Figure 1)	$t_{rr}$	—	—	5.0	ns
Forward Voltage ( $I_F = 1.0 \text{ mAdc}$ )	$V_F$	—	0.29	0.32	Vdc
Forward Voltage ( $I_F = 10 \text{ mAdc}$ )	$V_F$	—	0.35	0.40	Vdc
Forward Current (DC)	$I_F$	—	—	200	mAdc
Repetitive Peak Forward Current	$I_{FRM}$	—	—	300	mAdc
Non-Repetitive Peak Forward Current ( $t < 1.0 \text{ s}$ )	$I_{FSM}$	—	—	600	mAdc

**LBAT54CLT1**

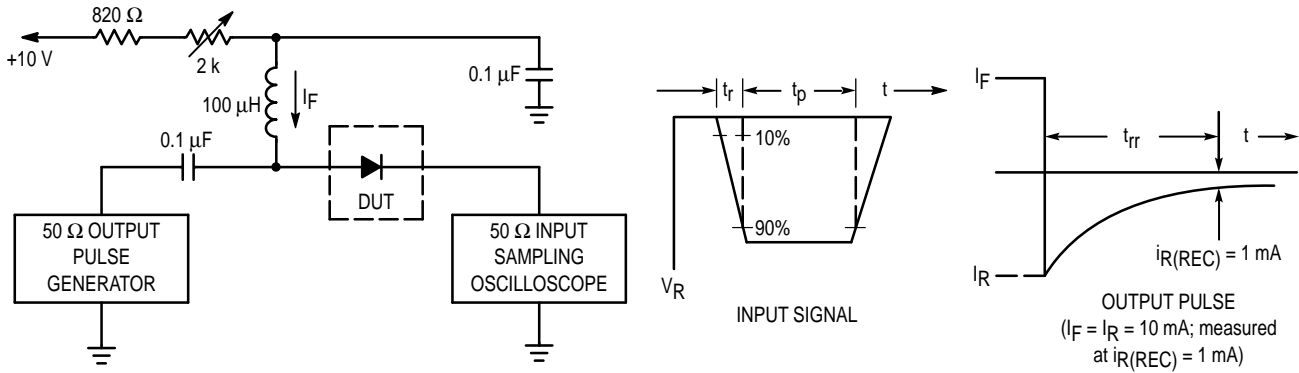

**Figure 1. Recovery Time Equivalent Test Circuit**

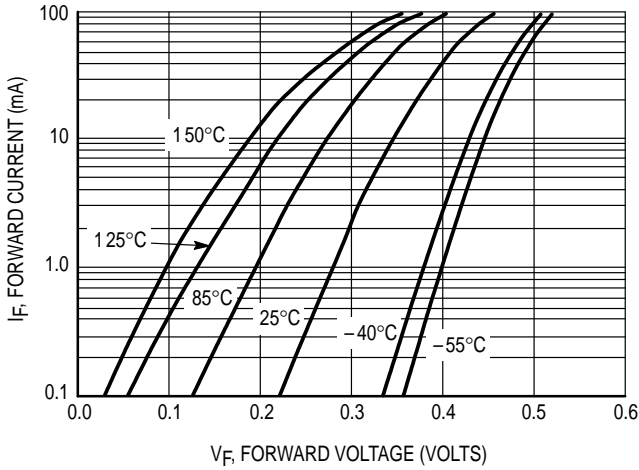

**Figure 2. Forward Voltage**

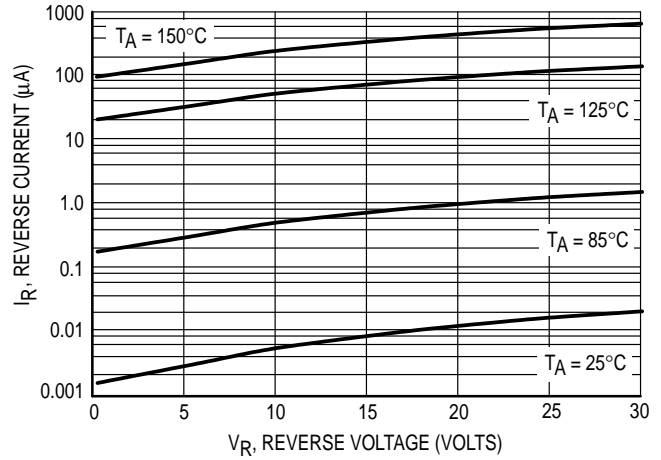

**Figure 3. Leakage Current**

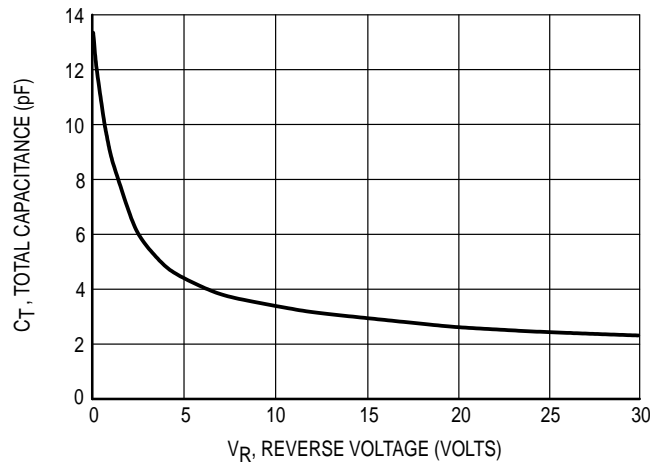

**Figure 4. Total Capacitance**

**LBAT54CLT1**

**SOT-23**

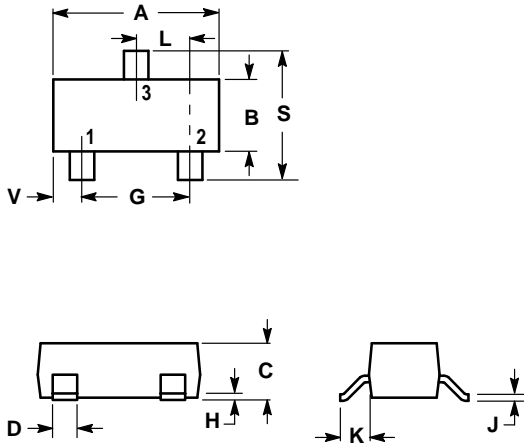

**NOTES:**

1. DIMENSIONING AND TOLERANCING PER ANSI Y14.5M, 1982.
2. CONTROLLING DIMENSION: INCH.

DIM	INCHES		MILLIMETERS	
	MIN	MAX	MIN	MAX
A	0.1102	0.1197	2.80	3.04
B	0.0472	0.0551	1.20	1.40
C	0.0350	0.0440	0.89	1.11
D	0.0150	0.0200	0.37	0.50
G	0.0701	0.0807	1.78	2.04
H	0.0005	0.0040	0.013	0.100
J	0.0034	0.0070	0.085	0.177
K	0.0140	0.0285	0.35	0.69
L	0.0350	0.0401	0.89	1.02
S	0.0830	0.1039	2.10	2.64
V	0.0177	0.0236	0.45	0.60

- PIN 1. ANODE  
 2. ANODE  
 3. CATHODE

