

# General Purpose Transistors

## PNP Silicon

These transistors are designed for general purpose amplifier applications. They are housed in the SOT-323/SC-70 which is designed for low power surface mount applications.

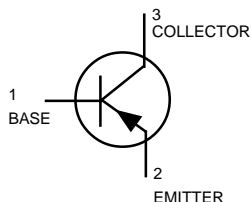

**BC856AWT1, BWT1**  
**BC857AWT1, BWT1**  
**BC858AWT1, BWT1**  
**CWT1**

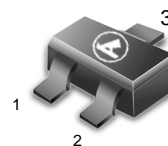

**CASE 419-02, STYLE 3**  
**SOT- 323 / SC-70**

### MAXIMUM RATINGS

Rating	Symbol	BC856	BC857	BC858	Unit
Collector–Emitter Voltage	$V_{CEO}$	-65	-45	-30	V
Collector–Base Voltage	$V_{CBO}$	-80	-50	-30	V
Emitter–Base Voltage	$V_{EBO}$	-5.0	-5.0	-5.0	V
Collector Current — Continuous	$I_C$	-100	-100	-100	mAdc

### THERMAL CHARACTERISTICS

Characteristic	Symbol	Max	Unit
Total Device Dissipation FR-5 Board, (1) $T_A = 25^\circ\text{C}$	$P_D$	150	mW
Thermal Resistance, Junction to Ambient	$R_{\theta JA}$	833	$^\circ\text{C/W}$
Junction and Storage Temperature	$T_J, T_{stg}$	-55 to +150	$^\circ\text{C}$

### DEVICE MARKING

BC856AWT1 = 3A; BC856BWT1 = 3B; BC857AWT1 = 3E; BC857BWT1 = 3F;  
 BC858AWT1 = 3J; BC858BWT1 = 3K; BC858CWT1 = 3L

### ELECTRICAL CHARACTERISTICS ( $T_A = 25^\circ\text{C}$ unless otherwise noted.)

Characteristic	Symbol	Min	Typ	Max	Unit
----------------	--------	-----	-----	-----	------

#### OFF CHARACTERISTICS

Collector–Emitter Breakdown Voltage ( $I_C = -10\text{ mA}$ )	BC856 Series	-65	—	—	
	BC857 Series	$V_{(BR)CEO}$	-45	—	v
	BC858 Series	-30	—	—	
Collector–Emitter Breakdown Voltage ( $I_C = -10\ \mu\text{A}, V_{EB} = 0$ )	BC856 Series	-80	—	—	
	BC857 Series	$V_{(BR)CES}$	-50	—	v
	BC858 Series	-30	—	—	
Collector–Base Breakdown Voltage ( $I_C = -10\ \mu\text{A}$ )	BC856 Series	-80	—	—	
	BC857 Series	$V_{(BR)CBO}$	-50	—	v
	BC858 Series	-30	—	—	
Emitter–Base Breakdown Voltage ( $I_E = -1.0\ \mu\text{A}$ )	BC856 Series	-5.0	—	—	
	BC857 Series,	$V_{(BR)EBO}$	-5.0	—	v
	BC858 Series	-5.0	—	—	
Collector Cutoff Current ( $V_{CB} = -30\text{ V}$ ) ( $V_{CB} = -30\text{ V}, T_A = 150^\circ\text{C}$ )		$I_{CBO}$	—	-15	nA
			—	-4.0	$\mu\text{A}$

1.FR-5=1.0 x 0.75 x 0.062in

**BC856AWT1, BWT1 BC857AWT1, BWT1 BC858AWT1, BWT1, CWT1**
**ELECTRICAL CHARACTERISTICS** ( $T_A = 25^\circ\text{C}$  unless otherwise noted) (Continued)

Characteristic	Symbol	Min	Typ	Max	Unit
----------------	--------	-----	-----	-----	------

**ON CHARACTERISTICS**

DC Current Gain ( $I_C = -10\ \mu\text{A}$ , $V_{CE} = -5.0\ \text{V}$ )	BC856A, BC857A, BC858A	$h_{FE}$	—	90	—	—
	BC856B, BC857B, BC858B		—	150	—	
	BC858C,		—	270	—	
( $I_C = -2.0\ \text{mA}$ , $V_{CE} = -5.0\ \text{V}$ )	BC856A, BC857A, BC858A		125	180	250	
	BC856B, BC857B, BC858B		220	290	475	
	BC858C		420	520	800	
Collector–Emitter Saturation Voltage ( $I_C = -10\ \text{mA}$ , $I_B = -0.5\ \text{mA}$ ) ( $I_C = -100\ \text{mA}$ , $I_B = -5.0\ \text{mA}$ )		$V_{CE(sat)}$	—	—	-0.3	V
			—	—	-0.65	
Base–Emitter Saturation Voltage ( $I_C = -10\ \text{mA}$ , $I_B = -0.5\ \text{mA}$ ) ( $I_C = -100\ \text{mA}$ , $I_B = -5.0\ \text{mA}$ )		$V_{BE(sat)}$	—	-0.7	—	V
			—	-0.9	—	
Base–Emitter Voltage ( $I_C = -2.0\ \text{mA}$ , $V_{CE} = -5.0\ \text{V}$ ) ( $I_C = -10\ \text{mA}$ , $V_{CE} = -5.0\ \text{V}$ )		$V_{BE(on)}$	-0.6	—	-0.75	V
			—	—	-0.82	

**SMALL–SIGNAL CHARACTERISTICS**

Current–Gain — Bandwidth Product ( $I_C = -10\ \text{mA}$ , $V_{CE} = -5.0\ \text{Vdc}$ , $f = 100\ \text{MHz}$ )	$f_T$	100	—	—	MHz
Output Capacitance ( $V_{CB} = -10\ \text{V}$ , $f = 1.0\ \text{MHz}$ )	$C_{ob}$	—	—	4.5	pF
Noise Figure ( $I_C = -0.2\ \text{mA}$ , $V_{CE} = -5.0\ \text{Vdc}$ , $R_S = 2.0\ \text{k}\Omega$ , $f = 1.0\ \text{kHz}$ , $BW = 200\ \text{Hz}$ )	NF	—	—	10	dB

BC856AWT1, BWT1 BC857AWT1, BWT1, BC858AWT1, BWT1, CWT1

BC857/BC858

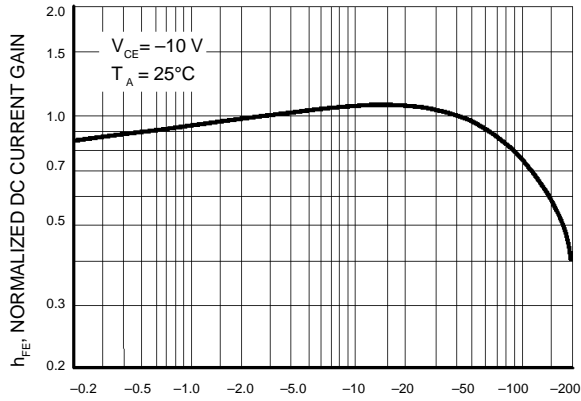

$I_C$ , COLLECTOR CURRENT (mAdc)  
Figure 1. Normalized DC Current Gain

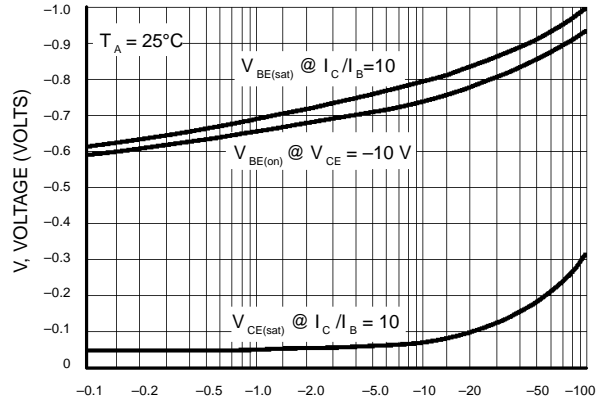

$I_C$ , COLLECTOR CURRENT (mAdc)  
Figure 2. "Saturation" and "On" Voltages

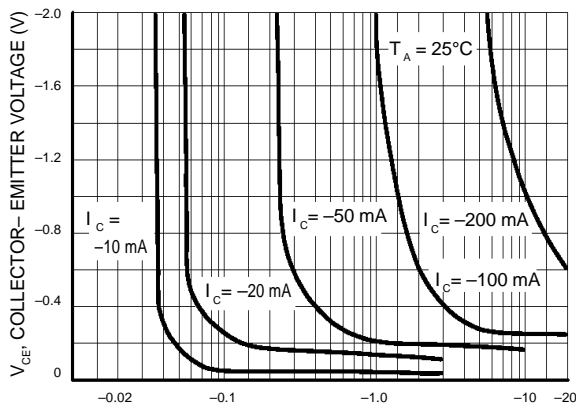

$I_B$ , BASE CURRENT (mA)  
Figure 3. Collector Saturation Region

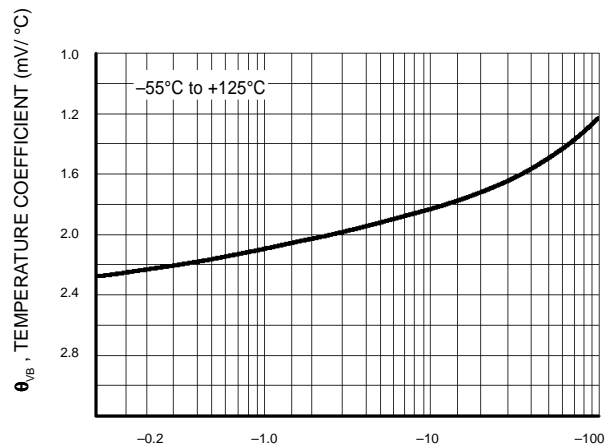

$I_C$ , COLLECTOR CURRENT (mA)  
Figure 4. Base-Emitter Temperature Coefficient

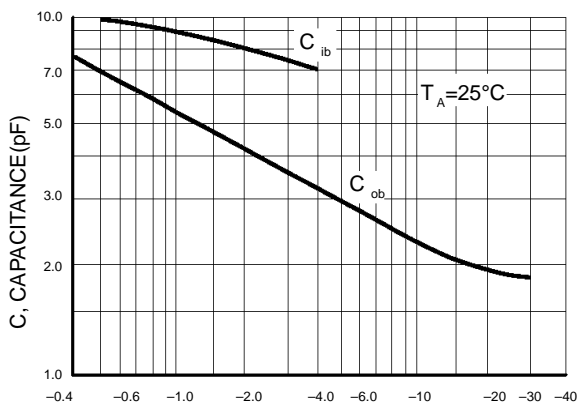

$V_R$ , REVERSE VOLTAGE (VOLTS)  
Figure 5. Capacitances

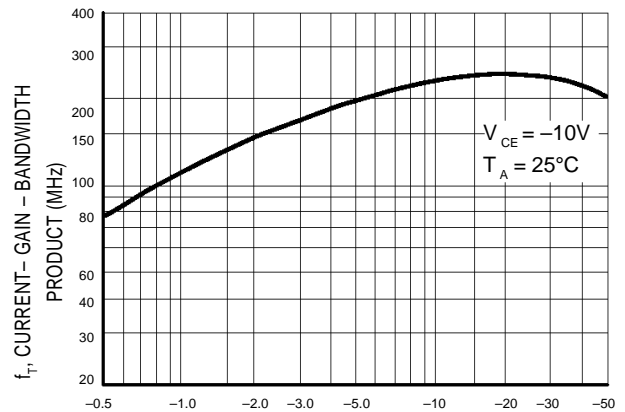

$I_C$ , COLLECTOR CURRENT (mAdc)  
Figure 6. Current-Gain - Bandwidth Product

BC856AWT1, BWT1 BC857AWT1, BWT1, BC858AWT1, BWT1, CWT1

BC856

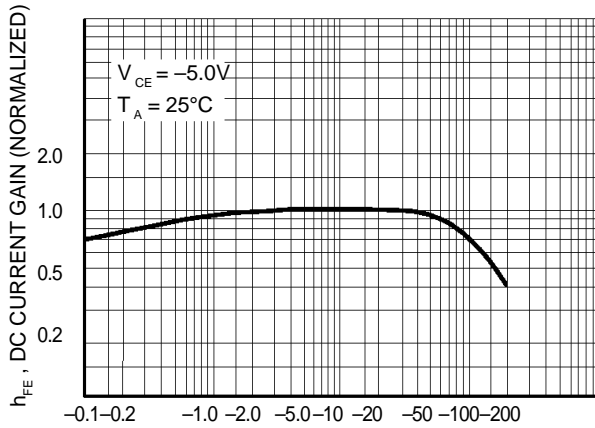

Figure 7. DC Current Gain

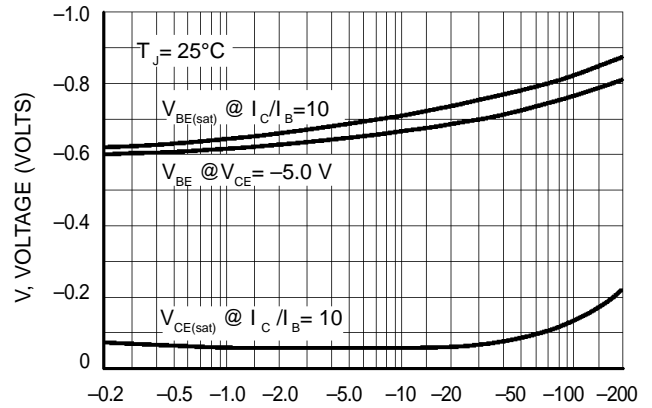

Figure 8. "On" Voltage

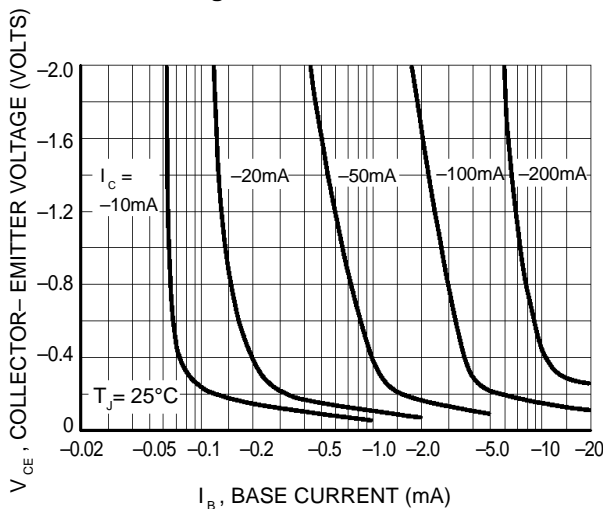

Figure 9. Collector Saturation Region

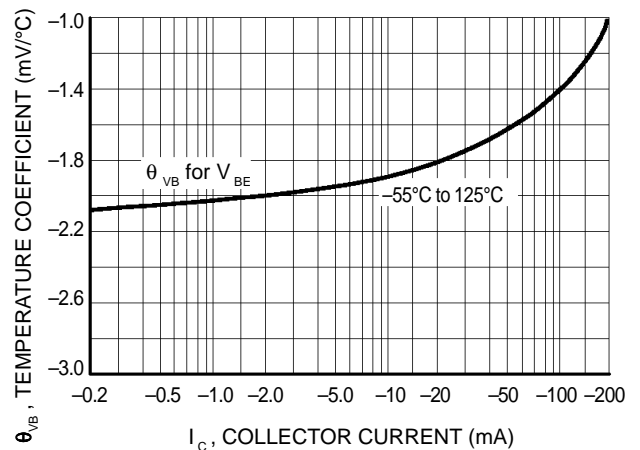

Figure 10. Base-Emitter Temperature Coefficient

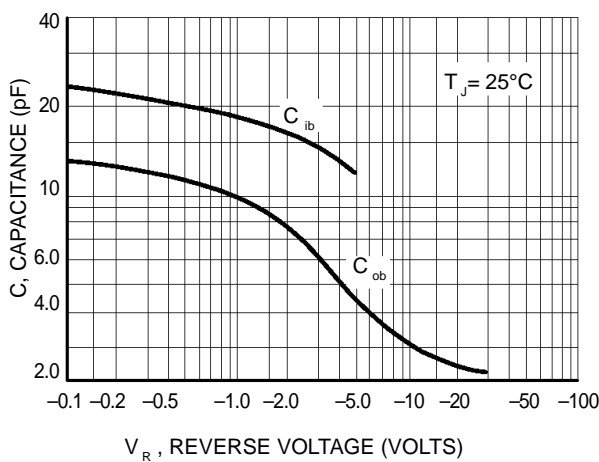

Figure 11. Capacitance

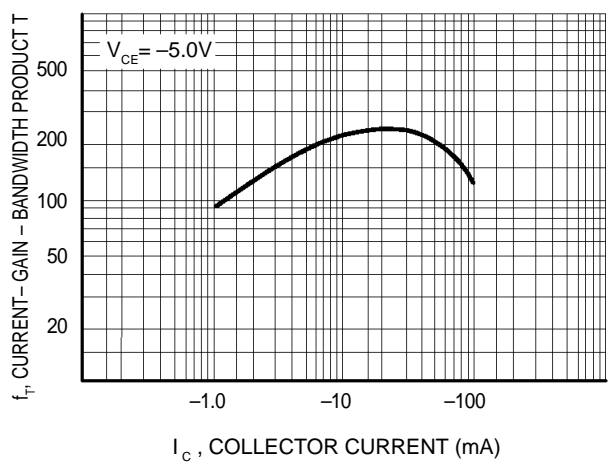

Figure 12. Current-Gain - Bandwidth Product

BC856AWT1, BWT1 BC857AWT1, BWT1, BC858AWT1, BWT1, CWT1

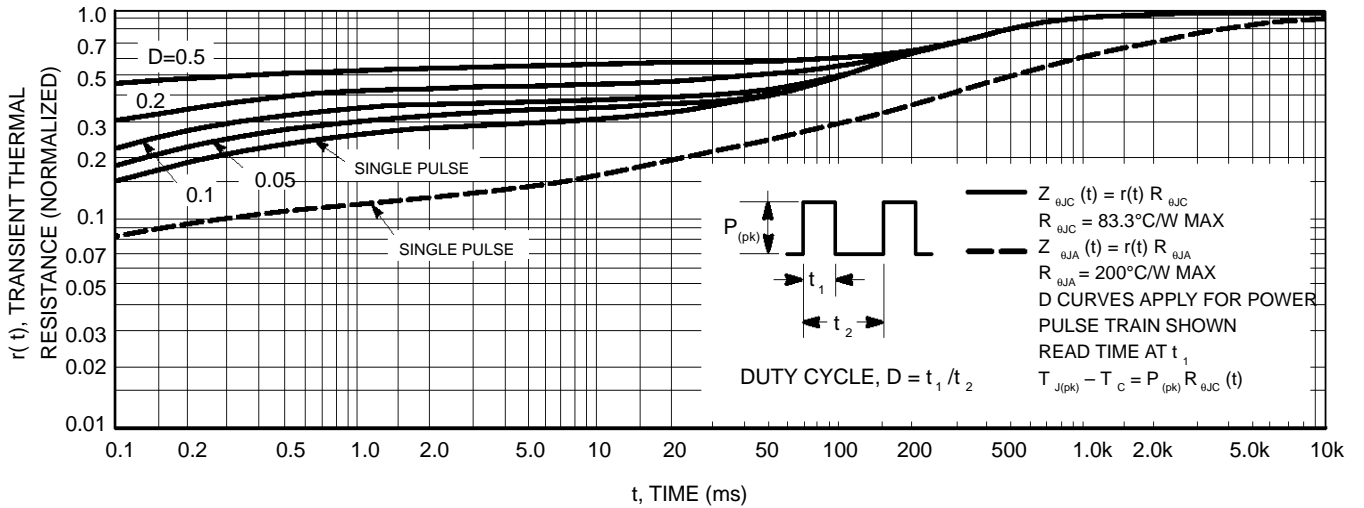

Figure 13. Thermal Response

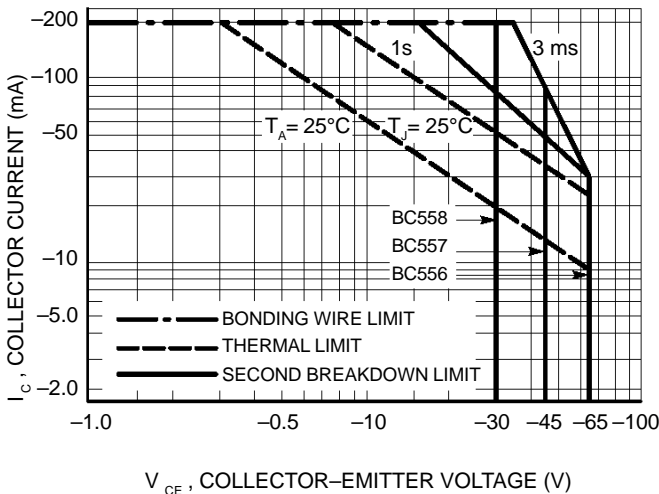

Figure 14. Active Region Safe Operating Area

The safe operating area curves indicate  $I_C - V_{CE}$  limits of the transistor that must be observed for reliable operation. Collector load lines for specific circuits must fall below the limits indicated by the applicable curve.

The data of Figure 14 is based upon  $T_{J(pk)} = 150^\circ\text{C}$ ;  $T_C$  or  $T_A$  is variable depending upon conditions. Pulse curves are valid for duty cycles to 10% provided  $T_{J(pk)} \leq 150^\circ\text{C}$ .  $T_{J(pk)}$  may be calculated from the data in Figure 13. At high case or ambient temperatures, thermal limitations will reduce the power that can be handled to values less than the limitations imposed by the secondary breakdown.