

FAST RECOVERY DIODES

Hockey Puk Version

Features

- High power FAST recovery diode series
- 4.5 μ s recovery time
- High voltage ratings up to 4500V
- High current capability
- Optimized turn on and turn off characteristics
- Low forward recovery
- Fast and soft reverse recovery
- Press-puk encapsulation
- Case style conform to JEDEC DO-200AB (B-PUK)
- Maximum junction temperature 125°C

Typical Applications

- Snubber diode for GTO
- High voltage free-wheeling diode
- Fast recovery rectifier applications

375A

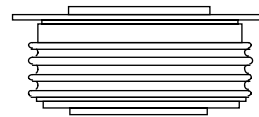

case style DO-200AB (B-PUK)

Major Ratings and Characteristics

Parameters	SD263C..S50L	Units
$I_{F(AV)}$	375	A
@ T_{hs}	55	°C
$I_{F(RMS)}$	408	A
I_{FSM} @ 50Hz	5500	A
@ 60Hz	5760	A
V_{RRM} range	3000 to 4500	V
t_{rr}	4.5	μ s
@ T_J	125	°C
T_J	- 40 to 125	°C

SD263C..S50L Series

Bulletin I2071 rev.B 04/00

International
IRF Rectifier

ELECTRICAL SPECIFICATIONS

Voltage Ratings

Type number	Voltage Code	V_{RRM} , maximum repetitive peak reverse voltage V	V_{RSM} , maximum non-repetitive peak rev. voltage V	I_{RRM} max. @ $T_J = T_J$ max. mA
SD263C..S50L	30	3000	3100	50
	36	3600	3700	
	40	4000	4100	
	45	4500	4600	

Forward Conduction

Parameter	SD263C..S50L	Units	Conditions
$I_{F(AV)}$ Max. average forward current @ Heatsink temperature	375 (150)	A	180° conduction, half sine wave Double side (single side) cooled
	55 (85)	°C	
$I_{F(RMS)}$ Max. RMS forward current	725	A	@ 25°C heatsink temperature double side cooled
I_{FSM} Max. peak, one-cycle forward, non-repetitive surge current	5500	A	t = 10ms No voltage reappplied
	5760		t = 8.3ms
	4630		t = 10ms 50% V_{RRM} reappplied
	4850		t = 8.3ms
I^2t Maximum I^2t for fusing	151	KA ² s	t = 10ms No voltage reappplied
	138		t = 8.3ms
	107		t = 10ms 50% V_{RRM} reappplied
	98		t = 8.3ms
$I^2\sqrt{t}$ Maximum $I^2\sqrt{t}$ for fusing	1510	KA ² /s	t = 0.1 to 10ms, no voltage reappplied
$V_{F(TO)1}$ Low level value of threshold voltage	1.56	V	$(16.7\% \times \pi \times I_{F(AV)} < I < \pi \times I_{F(AV)})$, $T_J = T_J$ max.
$V_{F(TO)2}$ High level value of threshold voltage	1.71		$(I > \pi \times I_{F(AV)})$, $T_J = T_J$ max.
r_{f1} Low level value of forward slope resistance	1.64	mΩ	$(16.7\% \times \pi \times I_{F(AV)} < I < \pi \times I_{F(AV)})$, $T_J = T_J$ max.
r_{f2} High level value of forward slope resistance	1.53		$(I > \pi \times I_{F(AV)})$, $T_J = T_J$ max.
V_{FM} Max. forward voltage drop	3.20	V	$I_{pk} = 1000A$, $T_J = T_J$ max, $t_p = 10ms$ sinusoidal wave

Recovery Characteristics

Code	$T_J = 25^\circ\text{C}$ typical t_{rr} @ 25% I_{RRM} (μs)	Test conditions			Max. values @ $T_J = 125^\circ\text{C}$			
		I_{pk} Square Pulse (A)	di/dt (*) (A/μs)	V_r (V)	t_{rr} @ 25% I_{RRM} (μs)	Q_{rr} (μC)	I_{rr} (A)	
S50	5.0	1000	100	-50	4.5	680	240	

(*) di/dt = 25A/μs @ $T_J = 25^\circ\text{C}$

Thermal and Mechanical Specifications

Parameter	SD263C..S50L	Units	Conditions
T _J Max. junction operating temperature range	-40 to 125	°C	
T _{stg} Max. storage temperature range	-40 to 150		
R _{thJ-hs} Max. thermal resistance, junction to heatsink	0.11 0.05	K/W	DC operation single side cooled DC operation double side cooled
F Mounting force, ± 10%	9800 (1000)	N (Kg)	
wt Approximate weight	230	g	
Case style	DO-200AB (B-PUK)		See outline table

ΔR_{thJ-hs} Conduction

(The following table shows the increment of thermal resistance R_{thJ-hs} when devices operate at different conduction angles than DC)

Conduction angle	Sinusoidal conduction		Rectangular conduction		Units	Conditions
	Single Side	Double Side	Single Side	Double Side		
180°	0.012	0.011	0.008	0.008	K/W	T _J = T _J max.
120°	0.014	0.015	0.014	0.014		
90°	0.018	0.018	0.019	0.019		
60°	0.026	0.027	0.027	0.028		
30°	0.045	0.046	0.046	0.046		

Ordering Information Table

Device Code

SD	26	3	C	45	S50	L
①	②	③	④	⑤	⑥	⑦

- 1** - Diode
- 2** - Essential part number
- 3** - 3 = Fast recovery
- 4** - C = Ceramic Puk
- 5** - Voltage code: Code x 100 = V_{RRM} (See Voltage Ratings table)
- 6** - t_{rr} code
- 7** - L = Puk Case DO-200AB (B-PUK)

SD263C..S50L Series

Bulletin I2071 rev. B 04/00

International
IRF Rectifier

Outline Table

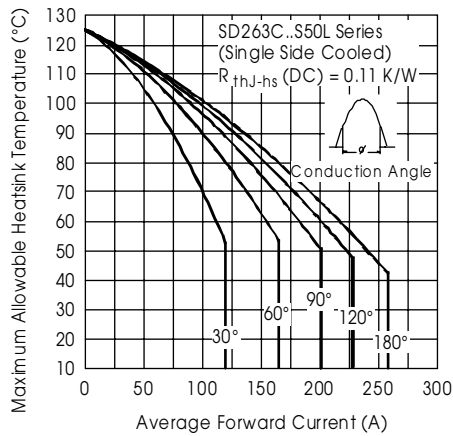
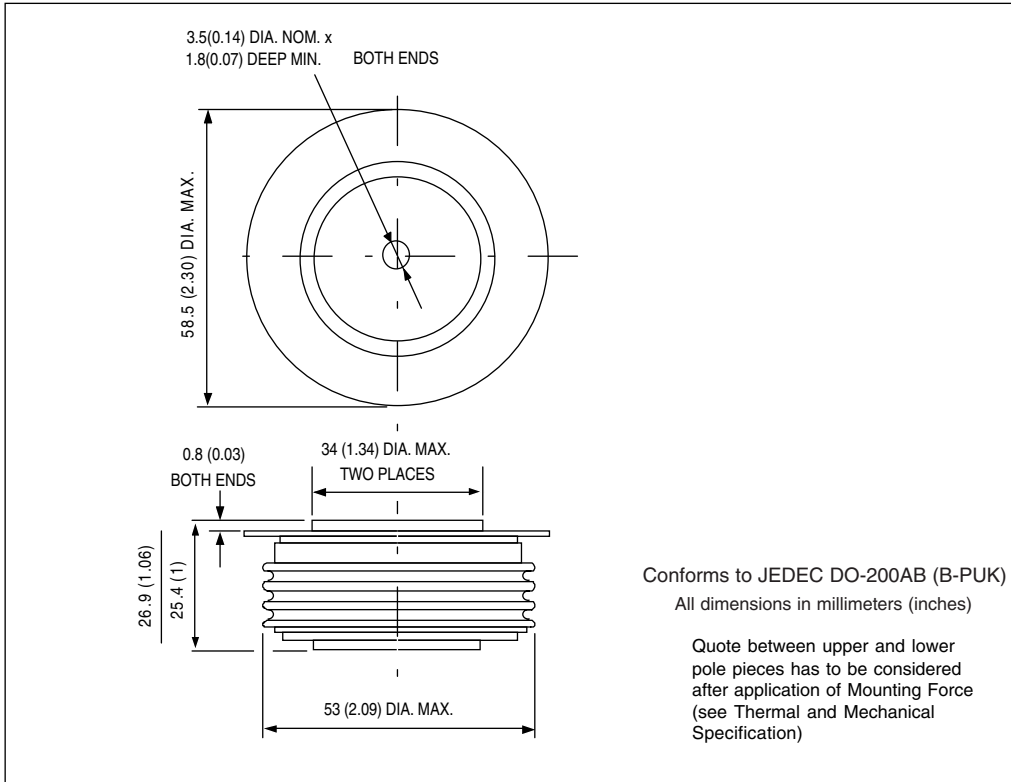

Fig. 1 - Current Ratings Characteristics

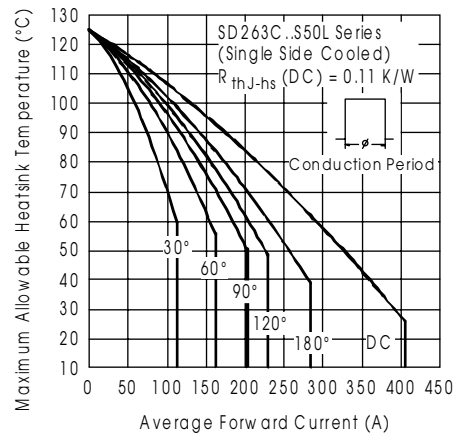

Fig. 2 - Current Ratings Characteristics

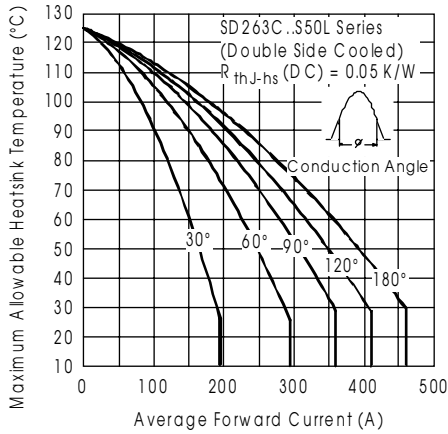

Fig. 3 - Current Ratings Characteristics

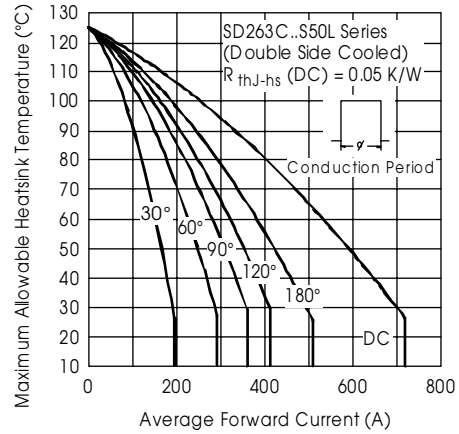

Fig. 4 - Current Ratings Characteristics

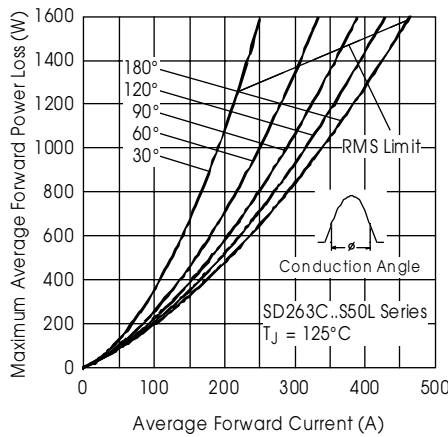

Fig. 5 - Forward Power Loss Characteristics

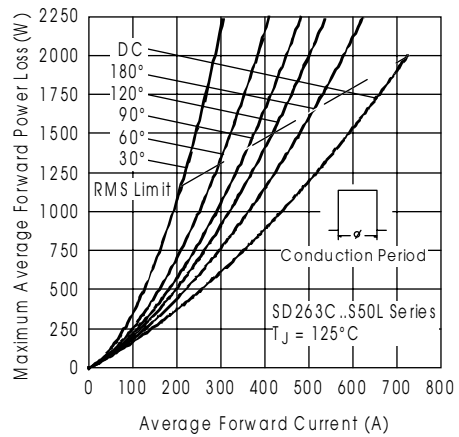

Fig. 6 - Forward Power Loss Characteristics

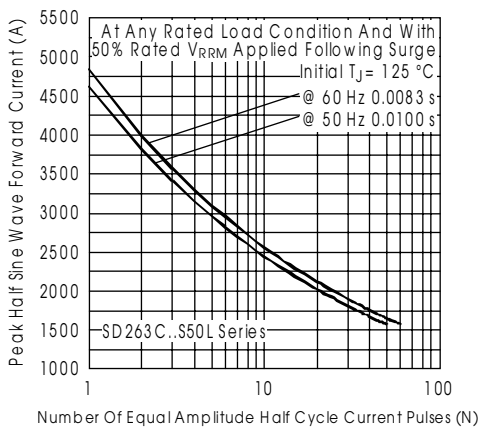

Fig. 7 - Maximum Non-repetitive Surge Current Single and Double Side Cooled

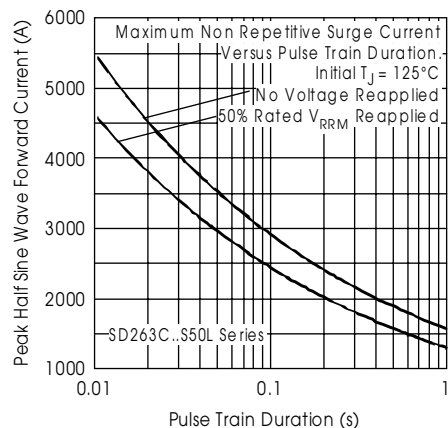

Fig. 8 - Maximum Non-repetitive Surge Current Single and Double Side Cooled

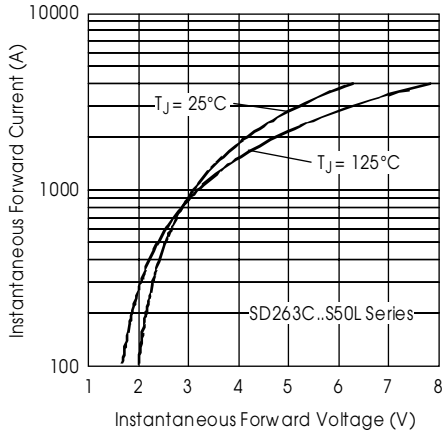

Fig. 9 - Forward Voltage Drop Characteristics

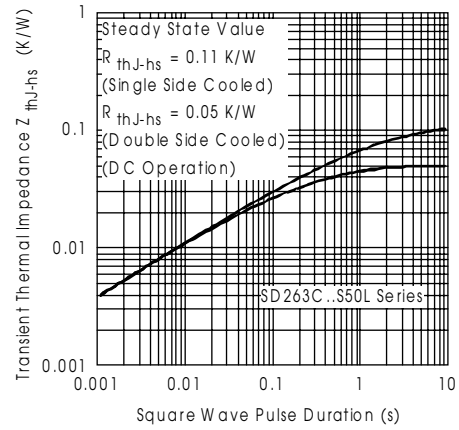

Fig. 10 - Thermal Impedance Z_{thj-hs} Characteristic

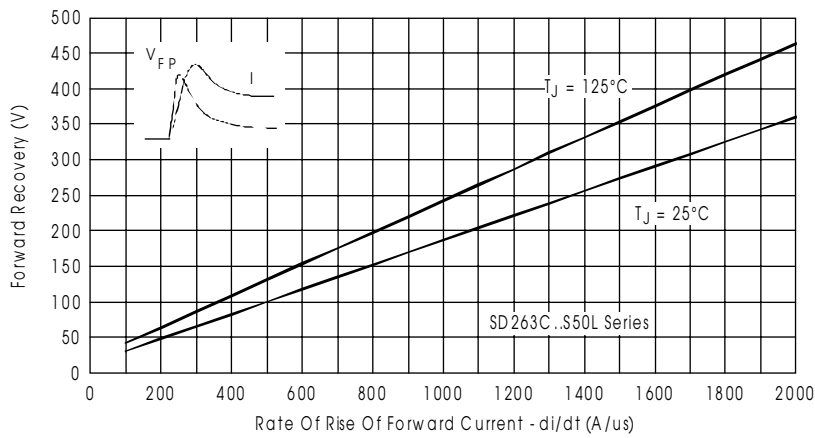

Fig. 11 - Typical Forward Recovery Characteristics

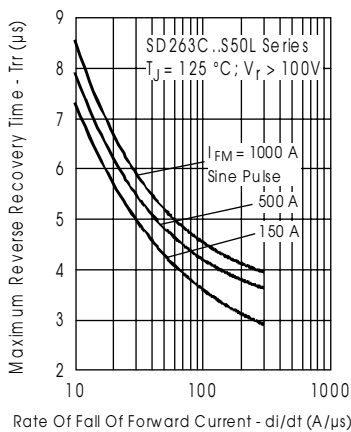

Fig. 12 - Recovery Time Characteristics

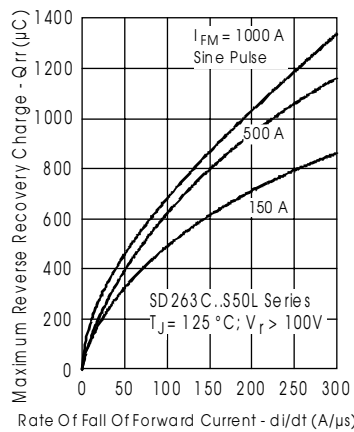

Fig. 13 - Recovery Charge Characteristics

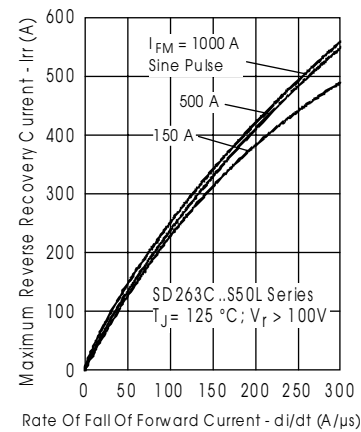

Fig. 14 - Recovery Current Characteristics

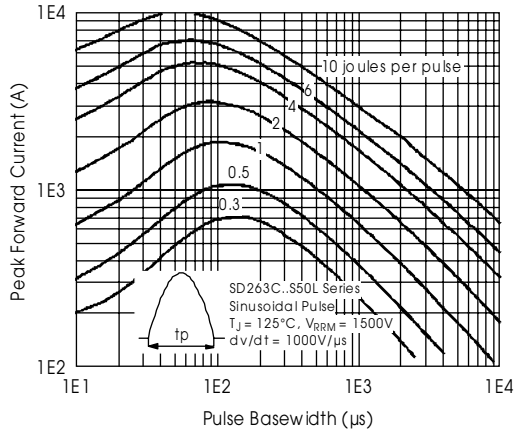

Fig. 15 - Maximum Total Energy Loss Per Pulse Characteristics

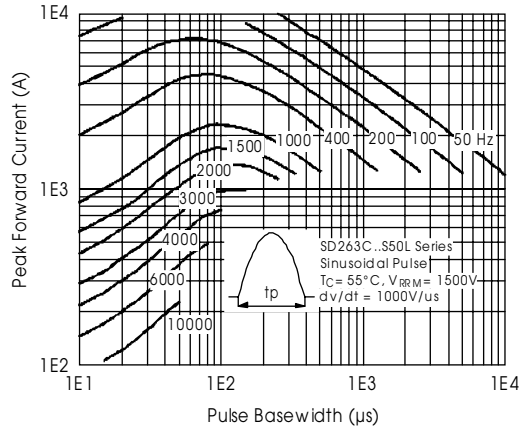

Fig. 16 - Frequency Characteristics

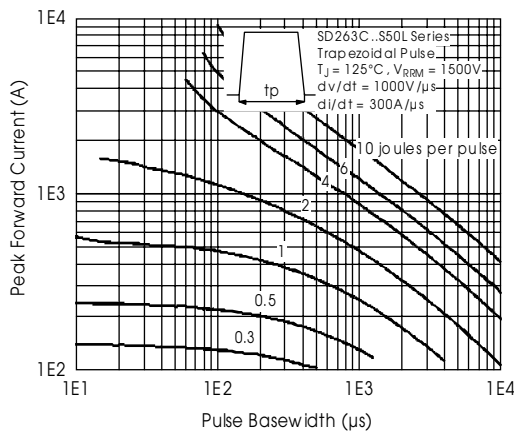

Fig. 17 - Maximum Total Energy Loss Per Pulse Characteristics

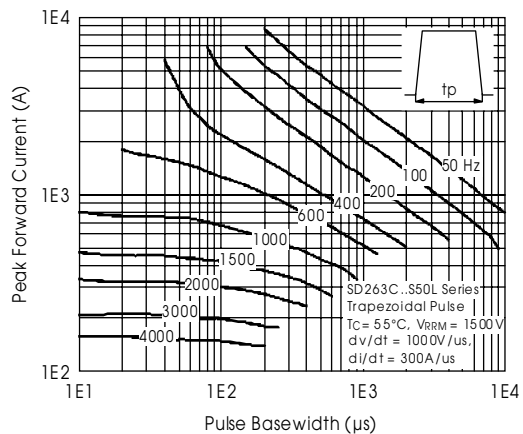

Fig. 18 - Frequency Characteristics

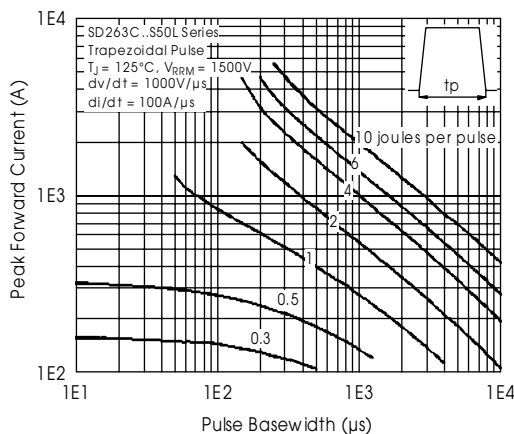

Fig. 19 - Maximum Total Energy Loss Per Pulse Characteristics

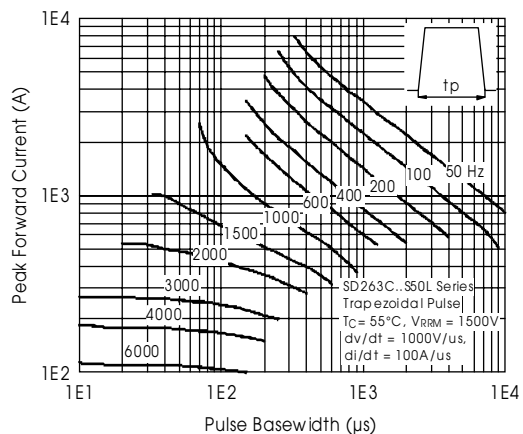

Fig. 20 - Frequency Characteristics

nt Characteristics