

STANDARD DIODES

SUPER MAGN-A-pak™ Power Modules

Features

- High current capability
- 3000 V_{RMS} isolating voltage with non-toxic substrate
- High surge capability
- High voltage ratings up to 2000V
- Industrial standard package
- UL E78996 approved 

600 A

Typical Applications

- Rectifying bridge for large motor drives
- Rectifying bridge for large UPS

Major Ratings and Characteristics

Parameters	IRKD600..	Units
$I_{F(AV)}$	600	A
@ T_C	100	°C
$I_{F(RMS)}$	942	A
@ T_C	100	°C
I_{FSM}	@ 50Hz	19.0 KA
	@ 60Hz	20.1 KA
I^2t	@ 50Hz	1805 KA ² s
	@ 60Hz	1683 KA ² s
$I^2\sqrt{t}$		18050 KA ² √s
V_{RRM} range	800 to 2000	V
T_{STG} range	-40 to 150	°C
T_J range	-40 to 150	°C

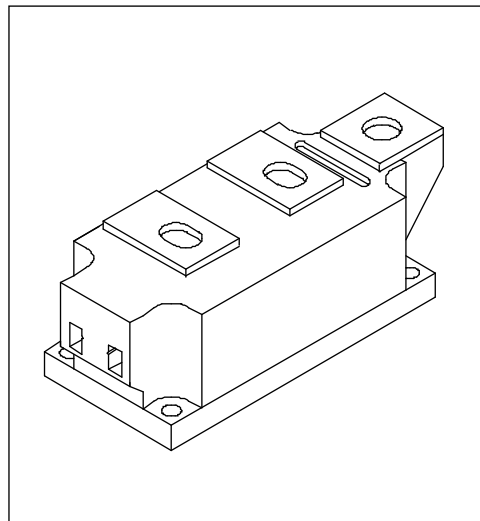

IRKD600.. Series

Bulletin I27402 rev. A 09/97

International
 Rectifier

ELECTRICAL SPECIFICATIONS

Voltage Ratings

Type number	Voltage Code	V_{RRM} , maximum repetitive peak reverse voltage V	V_{RSM} , maximum non-repetitive peak rev. voltage V	I_{RRM} max. @ T_J max. mA
IRKD600..	08	800	900	50
	12	1200	1300	
	16	1600	1700	
	20	2000	2100	

Forward Conduction

Parameter	IRKD600..	Units	Conditions
$I_{F(AV)}$ Maximum average forward current @ Case temperature	600	A	180° conduction, half sine wave
	100	°C	
$I_{F(RMS)}$ Maximum RMS forward current	942	A	180° conduction, half sine wave @ $T_C = 100^\circ\text{C}$
I_{FSM} Maximum peak, one-cycle forward, non-repetitive surge current	19.0	KA	t = 10ms No voltage reappplied
	20.1		t = 8.3ms 100% V_{RRM} reappplied
	16.2		t = 10ms Sinusoidal half wave, Initial $T_J = T_J$ max.
	17.2		t = 8.3ms 100% V_{RRM} reappplied
I^2t Maximum I^2t for fusing	1805	KA ² s	t = 10ms No voltage reappplied
	1683		t = 8.3ms 100% V_{RRM} reappplied
	1319		t = 10ms Sinusoidal half wave, Initial $T_J = T_J$ max.
	1230		t = 8.3ms 100% V_{RRM} reappplied
$I^2\sqrt{t}$ Maximum $I^2\sqrt{t}$ for fusing	18050	KA ² √s	t = 0.1 to 10ms, no voltage reappplied
$V_{F(TO)1}$ Low level value of threshold voltage	0.70	V	($16.7\% \times \pi \times I_{F(AV)} < I < \pi \times I_{F(AV)}$), $T_J = T_J$ max.
$V_{F(TO)2}$ High level value of threshold voltage	0.77		($I > \pi \times I_{F(AV)}$), $T_J = T_J$ max.
r_{f1} Low level value of forward slope resistance	0.28	mΩ	($16.7\% \times \pi \times I_{F(AV)} < I < \pi \times I_{F(AV)}$), $T_J = T_J$ max.
r_{f2} High level value of forward slope resistance	0.25		($I > \pi \times I_{F(AV)}$), $T_J = T_J$ max.
V_{FM} Maximum forward voltage drop	1.24	V	$I_{pk} = 1800\text{A}$, $T_J = 25^\circ\text{C}$, $t_p = 10\text{ms}$ sine pulse

Blocking

Parameter	IRKD600..	Units	Conditions
V_{INS} RMS isolation voltage	3000	V	t = 1 s
I_{RRM} Maximum peak reverse and off-state leakage current	50	mA	$T_J = T_J$ max., rated V_{RRM} applied

Thermal and Mechanical Specifications

Parameter	IRKD600..	Units	Conditions
T _J Max. junction operating temperature range	- 40 to 150	°C	
T _{stg} Max. storage temperature range	- 40 to 150		
R _{thJC} Max. thermal resistance, junction to case	0.065	K/W	Per junction, DC operation
R _{thC-hs} Max. thermal resistance, case to heatsink	0.02	K/W	
T Mounting torque ± 10%SMAP to heatsink busbar to SMAP	6 - 8 12 - 15	Nm	A mounting compound is recommended and the torque should be rechecked after a period of 3 hours to allow for the spread of the compound
wt Approximate weight	1500		
Case style	SUPER MAGN-A-pak		See outline table

ΔR_{thJC} Conduction

(The following table shows the increment of thermal resistance R_{thJC} when devices operate at different conduction angles than DC)

Conduction angle	Sinusoidal conduction	Rectangular conduction	Units	Conditions
180°	0.009	0.006	K/W	T _J = T _J max.
120°	0.011	0.011		
90°	0.014	0.015		
60°	0.021	0.022		
30°	0.037	0.038		

Ordering Information Table

Device Code

IRK	D	600	-	20
①	②	③		④

- 1 - Module type
- 2 - Circuit configuration D = 2 diodes in series
- 3 - Current rating
- 4 - Voltage code: Code x 100 = V_{RRM} (See Voltage Ratings Table)

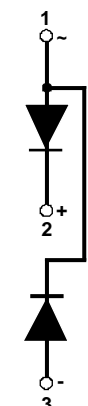

IRKD600.. Series

Bulletin I27402 rev. A 09/97



Outline Table

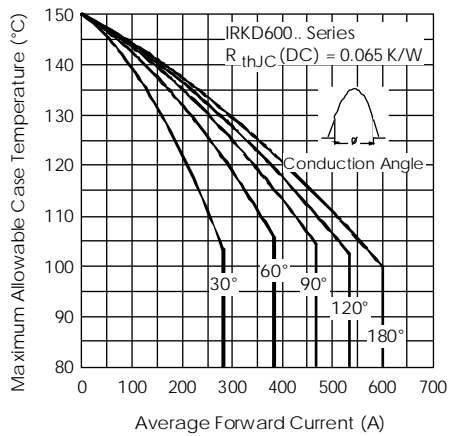
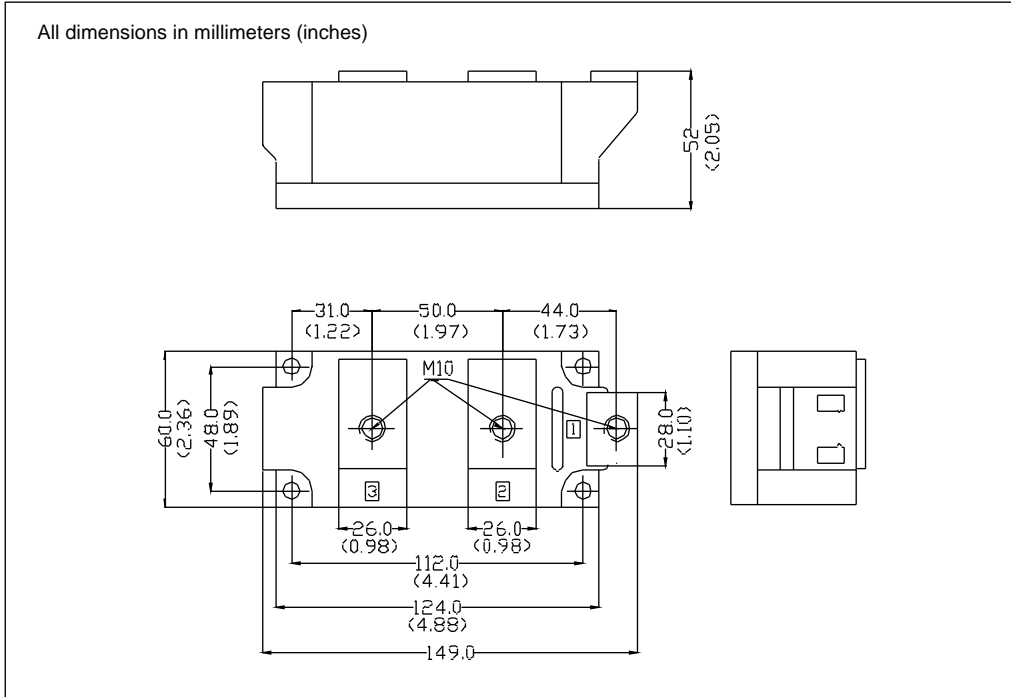

Fig. 1 - Current Ratings Characteristics

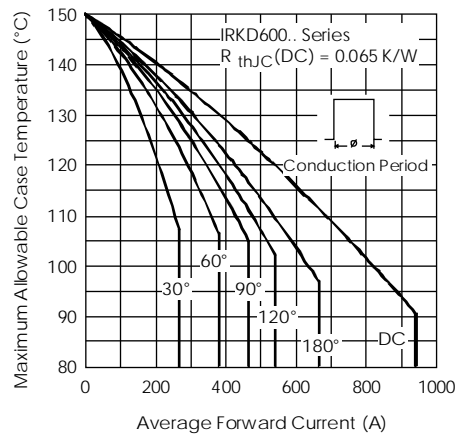

Fig. 2 - Current Ratings Characteristics

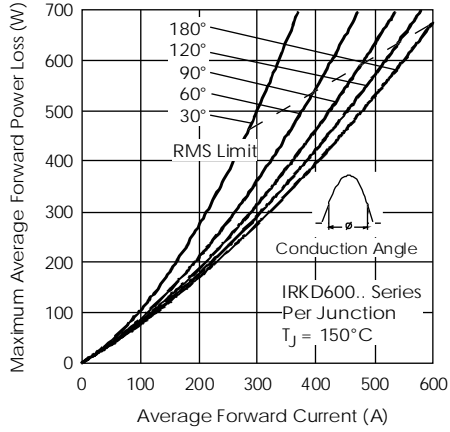

Fig. 3 - Forward Power Loss Characteristics

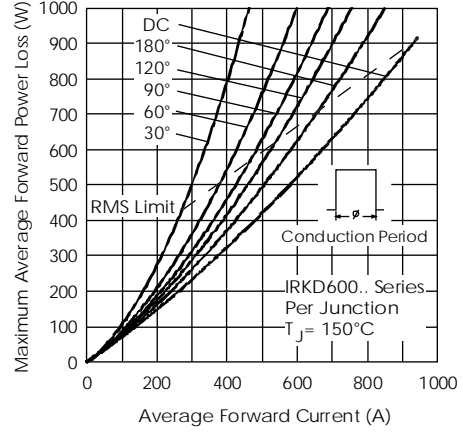

Fig. 4 - Forward Power Loss Characteristics

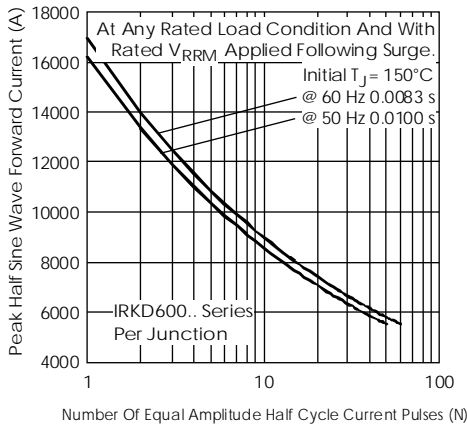

Fig. 5 - Maximum Non-Repetitive Surge Current

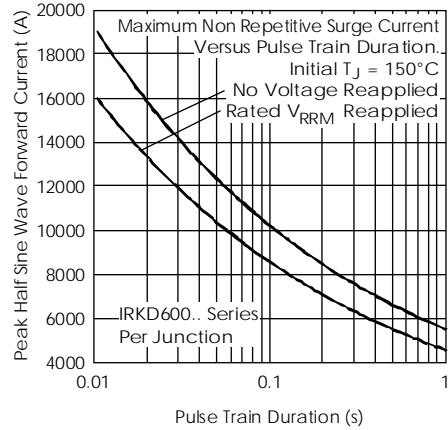

Fig. 6 - Maximum Non-Repetitive Surge Current

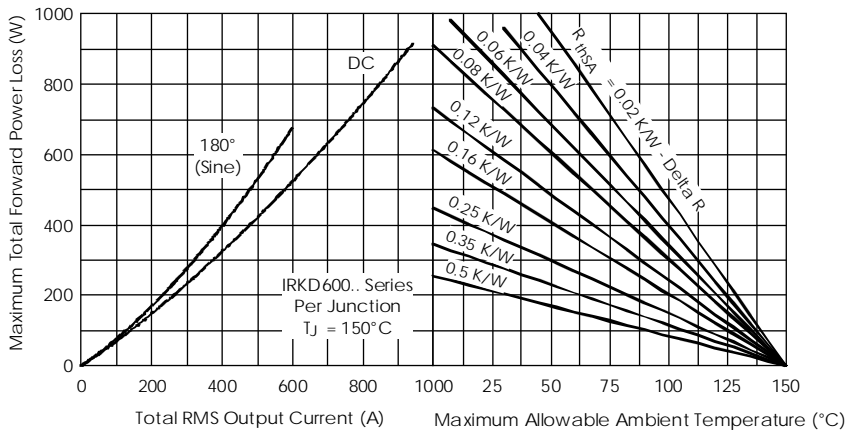

Fig. 7 - Forward Power Loss Characteristics

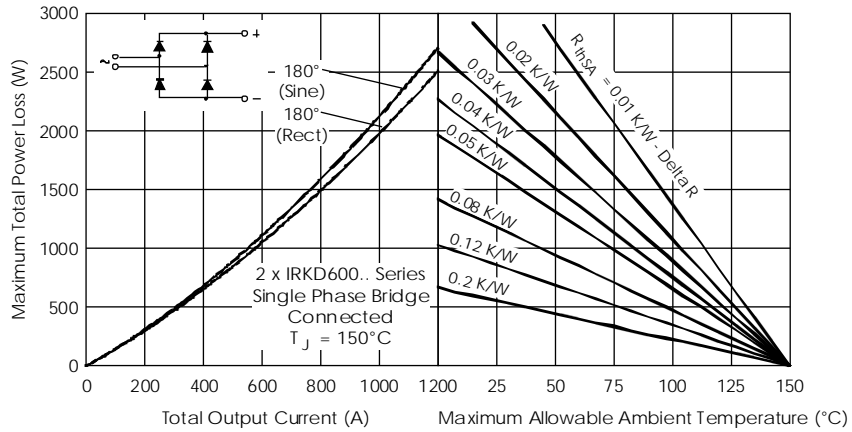

Fig. 8 - Forward Power Loss Characteristics

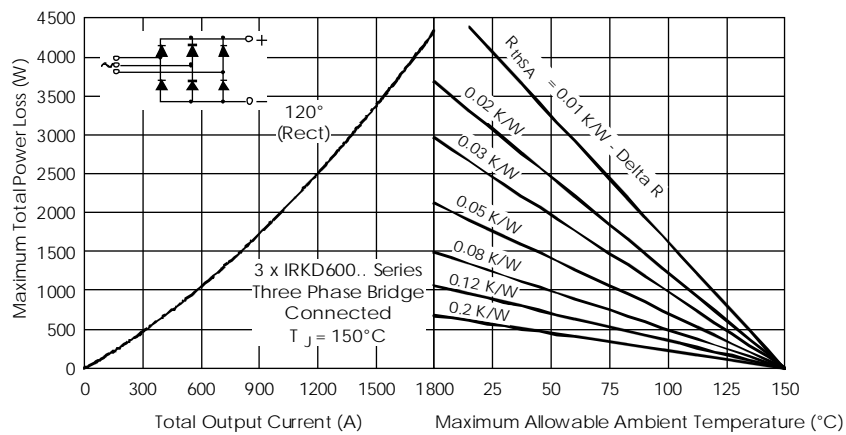

Fig. 9 - Forward Power Loss Characteristics

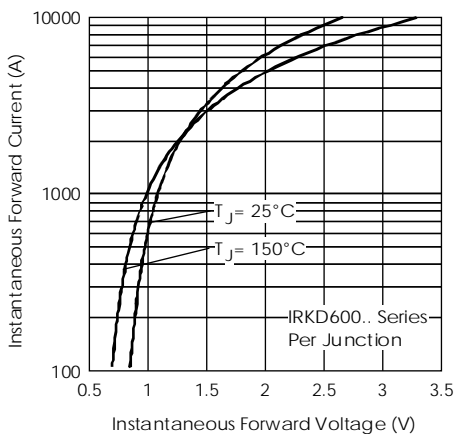

Fig. 10 - Forward Voltage Drop Characteristics

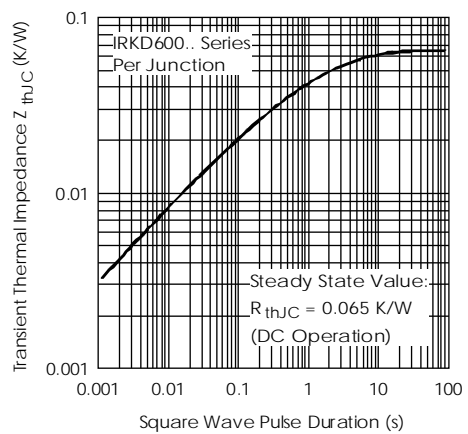

Fig. 11 - Thermal Impedance Z_{thJC} Characteristic