

PRELIMINARY

IRFZ44ES/L

HEXFET® Power MOSFET

- Advanced Process Technology
- Surface Mount (IRFZ44ES)
- Low-profile through-hole (IRFZ44EL)
- 175°C Operating Temperature
- Fast Switching
- Fully Avalanche Rated

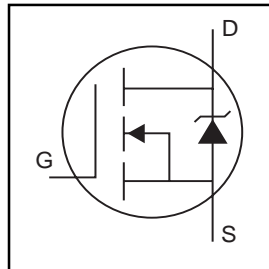

| |
|----------------------------|
| $V_{DSS} = 60V$ |
| $R_{DS(on)} = 0.023\Omega$ |
| $I_D = 48A$ |

Description

Fifth Generation HEXFETs from International Rectifier utilize advanced processing techniques to achieve extremely low on-resistance per silicon area. This benefit, combined with the fast switching speed and ruggedized device design that HEXFET Power MOSFETs are well known for, provides the designer with an extremely efficient and reliable device for use in a wide variety of applications.

The D²Pak is a surface mount power package capable of accommodating die sizes up to HEX-4. It provides the highest power capability and the lowest possible on-resistance in any existing surface mount package. The D²Pak is suitable for high current applications because of its low internal connection resistance and can dissipate up to 2.0W in a typical surface mount application. The through-hole version (IRFZ44EL) is available for low-profile applications.

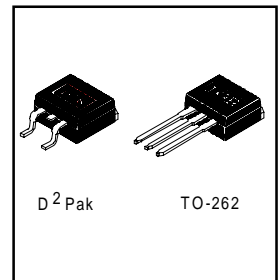

Absolute Maximum Ratings

| | Parameter | Max. | Units |
|---------------------------|--|--------------------|-------|
| $I_D @ T_C = 25^\circ C$ | Continuous Drain Current, $V_{GS} @ 10V$ Ⓞ | 48 | A |
| $I_D @ T_C = 100^\circ C$ | Continuous Drain Current, $V_{GS} @ 10V$ Ⓞ | 34 | |
| I_{DM} | Pulsed Drain Current ①Ⓞ | 192 | |
| $P_D @ T_C = 25^\circ C$ | Power Dissipation | 110 | W |
| | Linear Derating Factor | 0.71 | W/°C |
| V_{GS} | Gate-to-Source Voltage | ± 20 | V |
| E_{AS} | Single Pulse Avalanche Energy②Ⓞ | 220 | mJ |
| I_{AR} | Avalanche Current① | 29 | A |
| E_{AR} | Repetitive Avalanche Energy① | 11 | mJ |
| dv/dt | Peak Diode Recovery dv/dt ③Ⓞ | 5.0 | V/ns |
| T_J | Operating Junction and | -55 to +175 | °C |
| T_{STG} | Storage Temperature Range | | |
| | Soldering Temperature, for 10 seconds | | |
| | Mounting torque, 6-32 or M3 screw | 10 lbf•in (1.1N•m) | |

Thermal Resistance

| | Parameter | Typ. | Max. | Units |
|-----------------|-------------------------------------|------|------|-------|
| $R_{\theta JC}$ | Junction-to-Case | — | 1.4 | °C/W |
| $R_{\theta CS}$ | Case-to-Sink, Flat, Greased Surface | 0.50 | — | |
| $R_{\theta JA}$ | Junction-to-Ambient | — | 62 | |

Electrical Characteristics @ $T_J = 25^\circ\text{C}$ (unless otherwise specified)

| | Parameter | Min. | Typ. | Max. | Units | Conditions |
|---------------------|--------------------------------------|------|-------|-------|----------|--|
| $V_{(BR)DSS}$ | Drain-to-Source Breakdown Voltage | 60 | — | — | V | $V_{GS} = 0V, I_D = 250\mu A$ |
| $DV_{(BR)DSS}/DT_J$ | Breakdown Voltage Temp. Coefficient | — | 0.063 | — | V/°C | Reference to $25^\circ\text{C}, I_D = 1mA$ ⑤ |
| $R_{DS(on)}$ | Static Drain-to-Source On-Resistance | — | — | 0.023 | Ω | $V_{GS} = 10V, I_D = 29A$ ④ |
| $V_{GS(th)}$ | Gate Threshold Voltage | 2.0 | — | 4.0 | V | $V_{DS} = V_{GS}, I_D = 250\mu A$ |
| g_{fs} | Forward Transconductance | 15 | — | — | S | $V_{DS} = 30V, I_D = 29A$ ⑤ |
| I_{DSS} | Drain-to-Source Leakage Current | — | — | 25 | μA | $V_{DS} = 60V, V_{GS} = 0V$ |
| | | — | — | 250 | | $V_{DS} = 48V, V_{GS} = 0V, T_J = 150^\circ\text{C}$ |
| I_{GSS} | Gate-to-Source Forward Leakage | — | — | 100 | nA | $V_{GS} = 20V$ |
| | Gate-to-Source Reverse Leakage | — | — | -100 | | $V_{GS} = -20V$ |
| Q_g | Total Gate Charge | — | — | 60 | nC | $I_D = 29A$ |
| Q_{gs} | Gate-to-Source Charge | — | — | 13 | | $V_{DS} = 48V$ |
| Q_{gd} | Gate-to-Drain ("Miller") Charge | — | — | 23 | | $V_{GS} = 10V$, See Fig. 6 and 13 ④⑤ |
| $t_{d(on)}$ | Turn-On Delay Time | — | 12 | — | ns | $V_{DD} = 30V$ |
| t_r | Rise Time | — | 60 | — | | $I_D = 29A$ |
| $t_{d(off)}$ | Turn-Off Delay Time | — | 70 | — | | $R_G = 15\Omega$ |
| t_f | Fall Time | — | 70 | — | | $R_D = 1.1\Omega$, See Fig. 10 ④⑤ |
| L_S | Internal Source Inductance | — | 7.5 | — | nH | Between lead, and center of die contact |
| C_{iss} | Input Capacitance | — | 1360 | — | pF | $V_{GS} = 0V$ |
| C_{oss} | Output Capacitance | — | 420 | — | | $V_{DS} = 25V$ |
| C_{riss} | Reverse Transfer Capacitance | — | 160 | — | | $f = 1.0MHz$, See Fig. 5⑤ |

Source-Drain Ratings and Characteristics

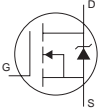
| | Parameter | Min. | Typ. | Max. | Units | Conditions |
|----------|--|---|------|------|-------|--|
| I_S | Continuous Source Current (Body Diode) | — | — | 48 | A | MOSFET symbol showing the integral reverse p-n junction diode.  |
| I_{SM} | Pulsed Source Current (Body Diode) ① | — | — | 192 | | |
| V_{SD} | Diode Forward Voltage | — | — | 1.3 | V | $T_J = 25^\circ\text{C}, I_S = 29A, V_{GS} = 0V$ ④ |
| t_{rr} | Reverse Recovery Time | — | 69 | 104 | ns | $T_J = 25^\circ\text{C}, I_F = 29A$ |
| Q_{rr} | Reverse Recovery Charge | — | 177 | 266 | nC | $di/dt = 100A/\mu s$ ④ |
| t_{on} | Forward Turn-On Time | Intrinsic turn-on time is negligible (turn-on is dominated by $L_S + L_D$) | | | | |

Notes:

① Repetitive rating; pulse width limited by max. junction temperature. (See fig. 11)

② Starting $T_J = 25^\circ\text{C}$, $L = 520\mu H$
 $R_G = 25\Omega$, $I_{AS} = 29A$. (See Figure 12)

③ $I_{SD} \leq 29A$, $di/dt \leq 320A/\mu s$, $V_{DD} \leq V_{(BR)DSS}$,
 $T_J \leq 175^\circ\text{C}$

④ Pulse width $\leq 300\mu s$; duty cycle $\leq 2\%$.

⑤ Uses IRFZ44E data and test conditions

** When mounted on 1" square PCB (FR-4 or G-10 Material).

For recommended soldering techniques refer to application note #AN-994.

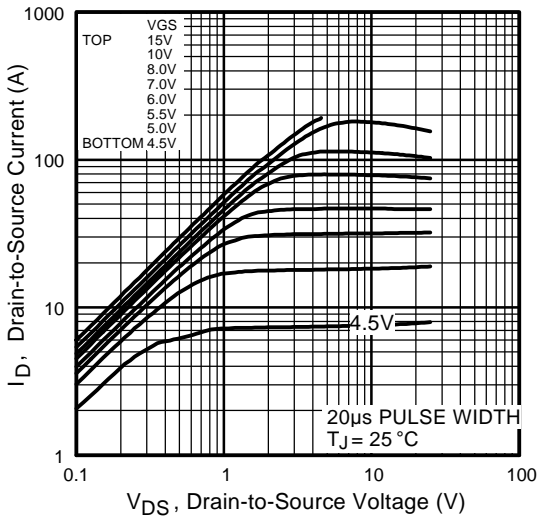

Fig 1. Typical Output Characteristics

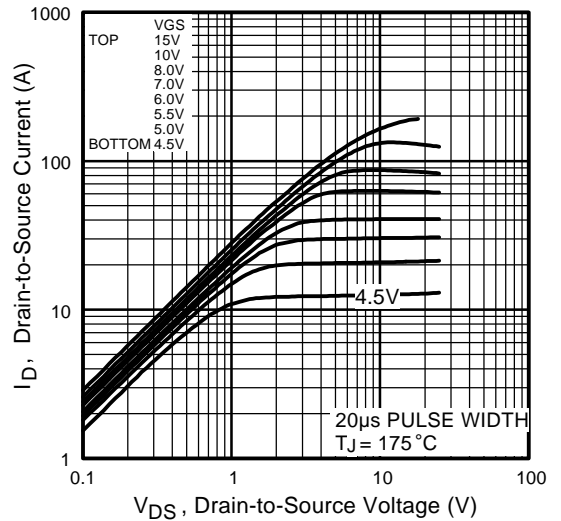

Fig 2. Typical Output Characteristics

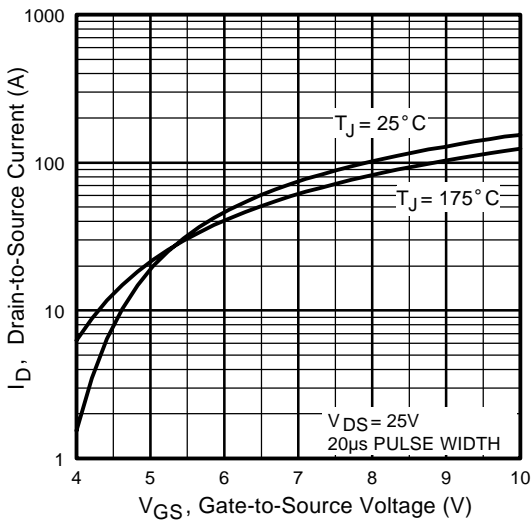

Fig 3. Typical Transfer Characteristics

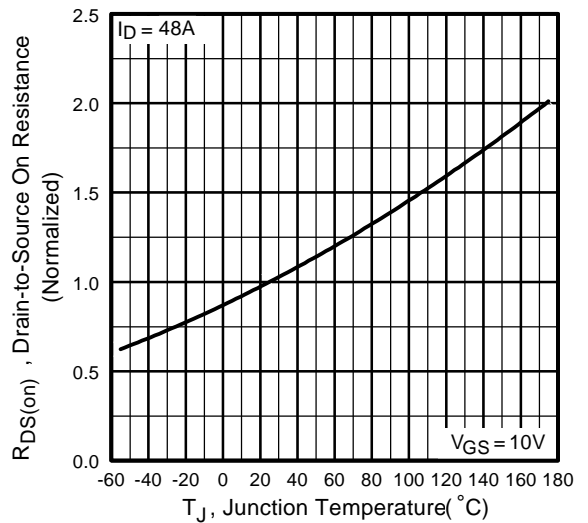

Fig 4. Normalized On-Resistance Vs. Temperature

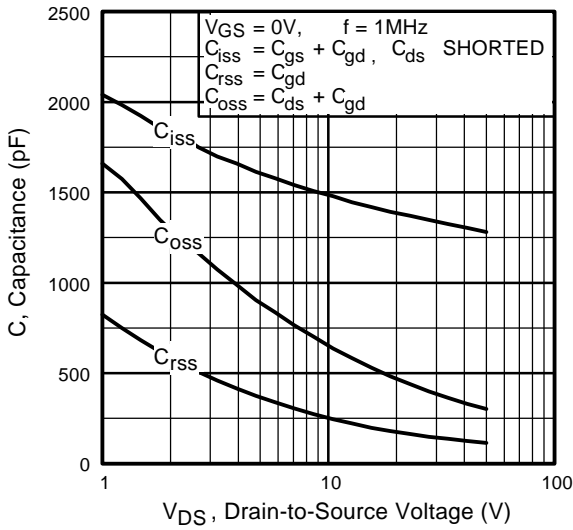

Fig 5. Typical Capacitance Vs. Drain-to-Source Voltage

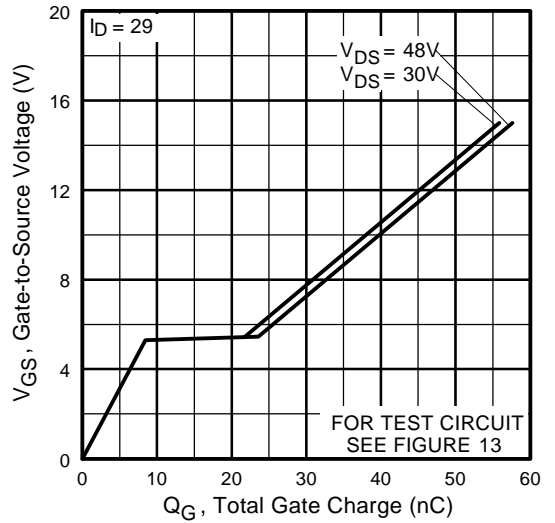

Fig 6. Typical Gate Charge Vs. Gate-to-Source Voltage

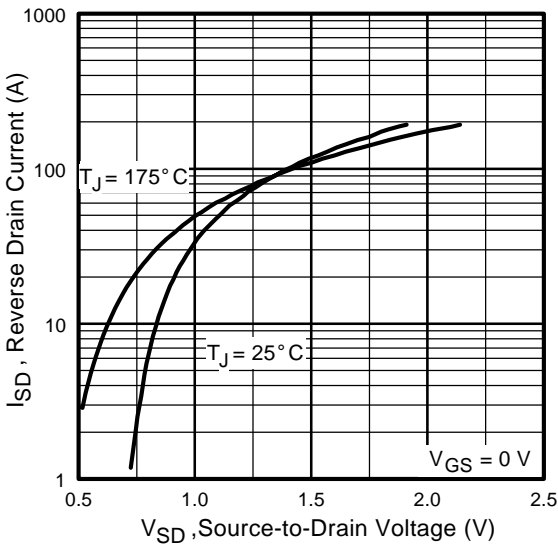

Fig 7. Typical Source-Drain Diode Forward Voltage

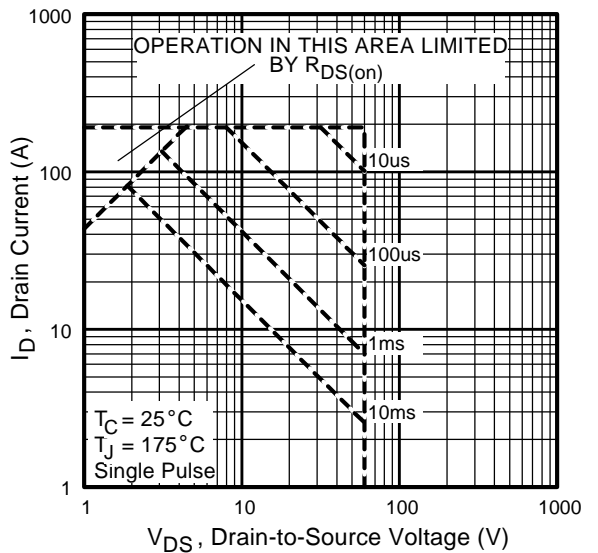

Fig 8. Maximum Safe Operating Area

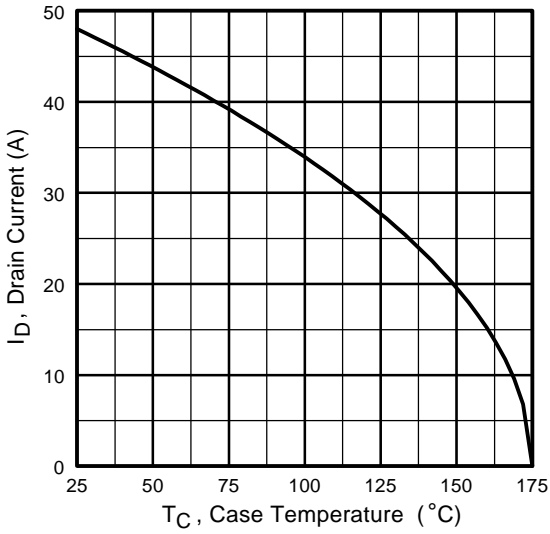

Fig 9. Maximum Drain Current Vs. Case Temperature

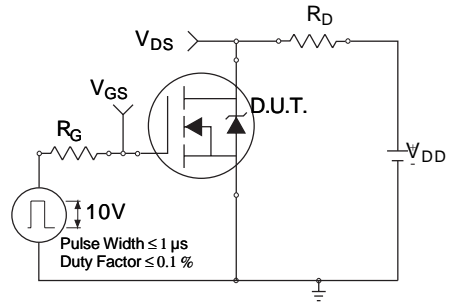

Fig 10a. Switching Time Test Circuit

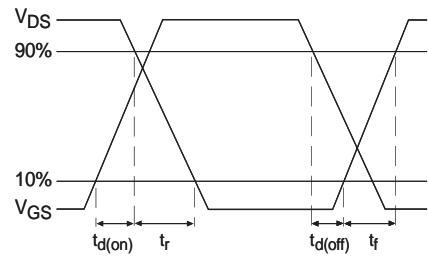

Fig 10b. Switching Time Waveforms

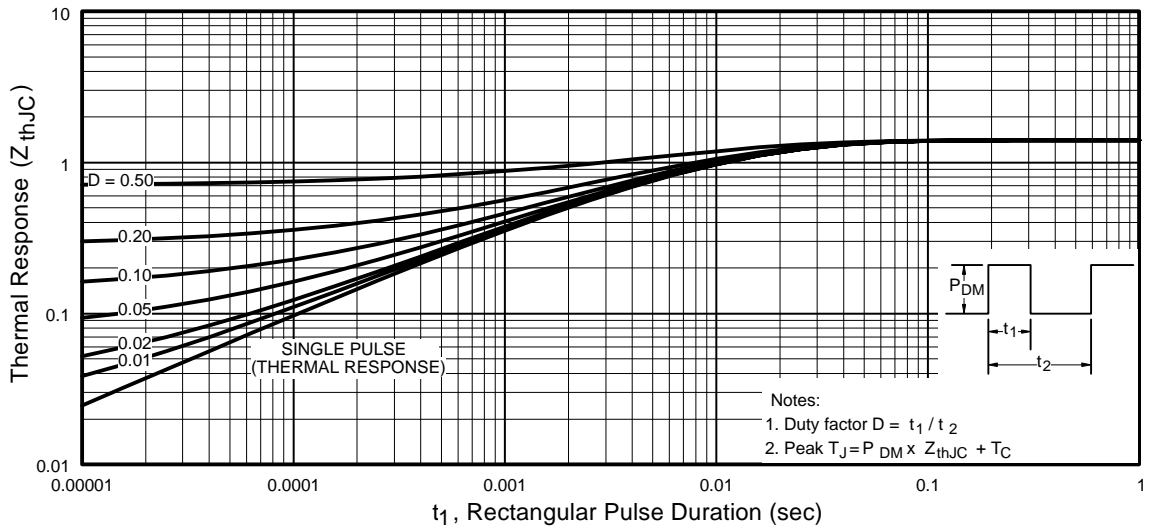

Fig 11. Maximum Effective Transient Thermal Impedance, Junction-to-Case

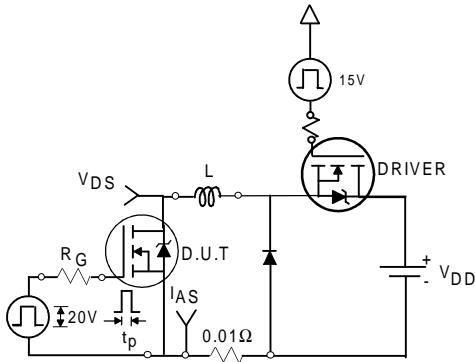

Fig 12a. Unclamped Inductive Test Circuit

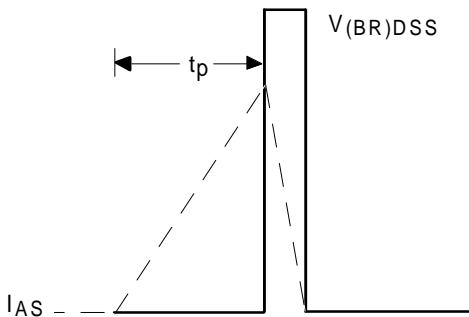

Fig 12b. Unclamped Inductive Waveforms

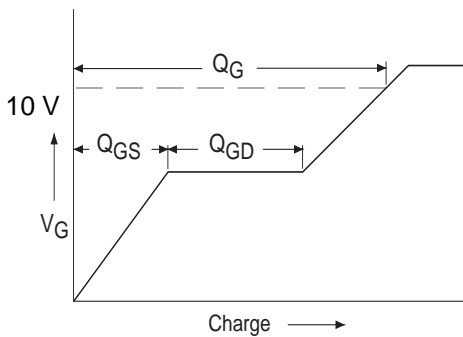

Fig 13a. Basic Gate Charge Waveform

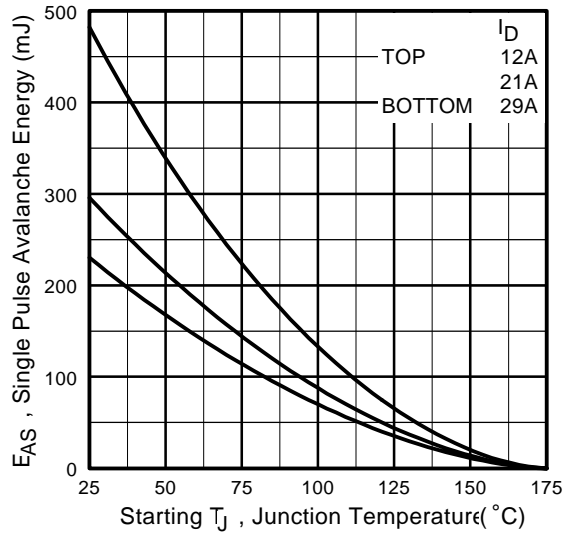

Fig 12c. Maximum Avalanche Energy Vs. Drain Current

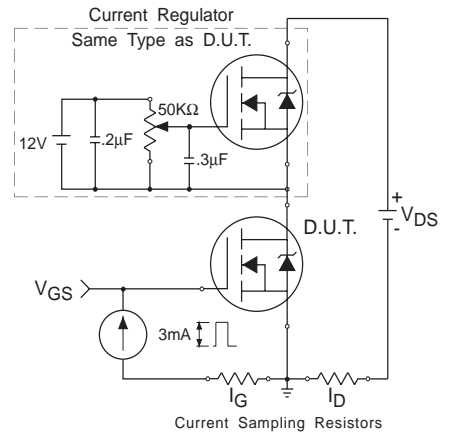
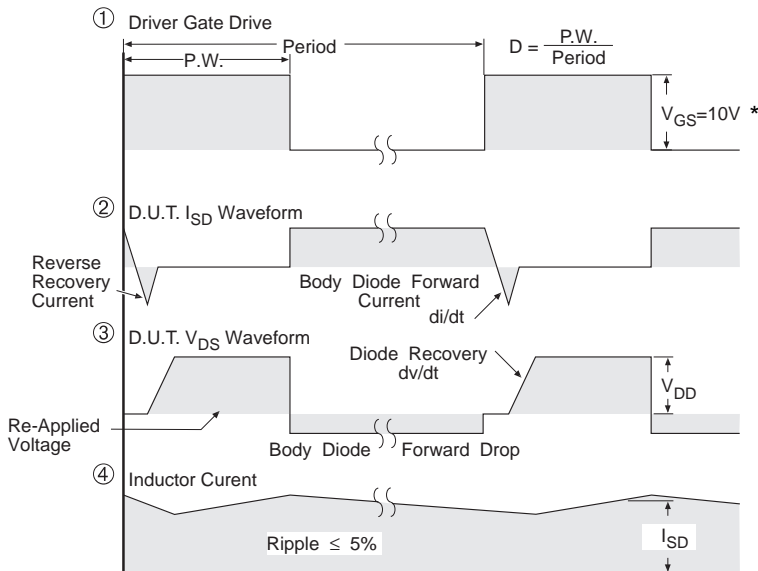
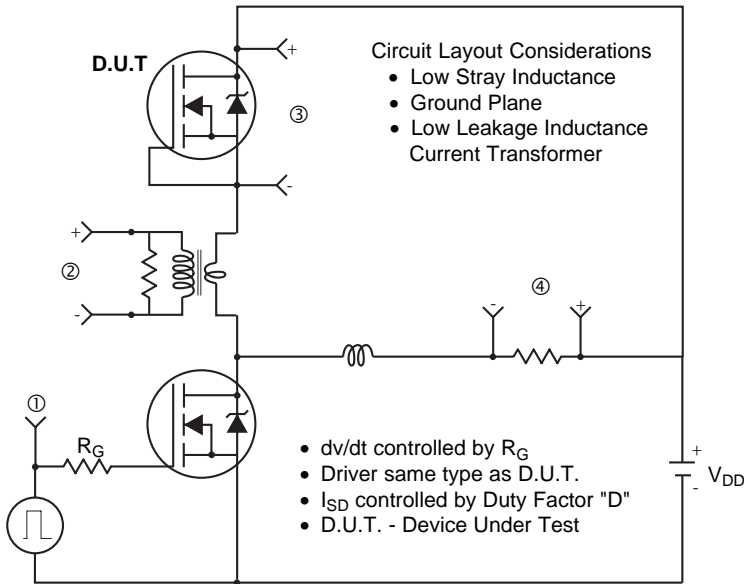

Fig 13b. Gate Charge Test Circuit

Peak Diode Recovery dv/dt Test Circuit



* $V_{GS} = 5V$ for Logic Level Devices

Fig 14. For N-Channel HEXFETS

IRFZ44ES/L

D²Pak Package Outline

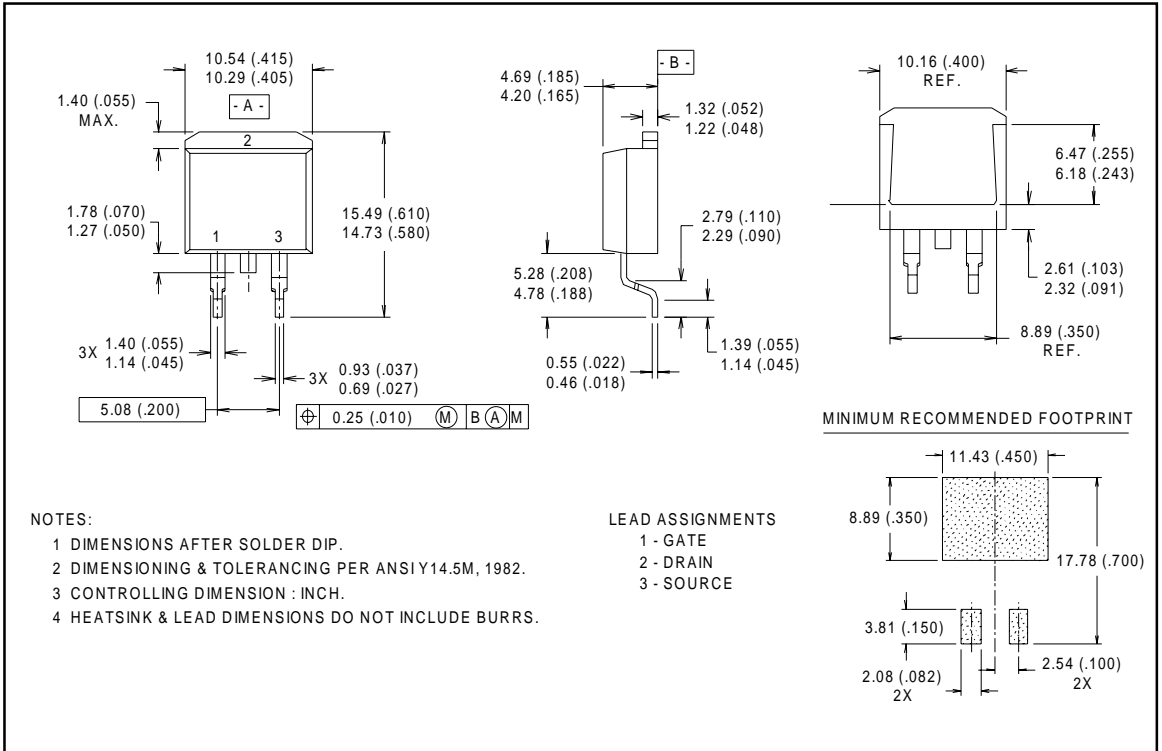

Part Marking Information

D²Pak

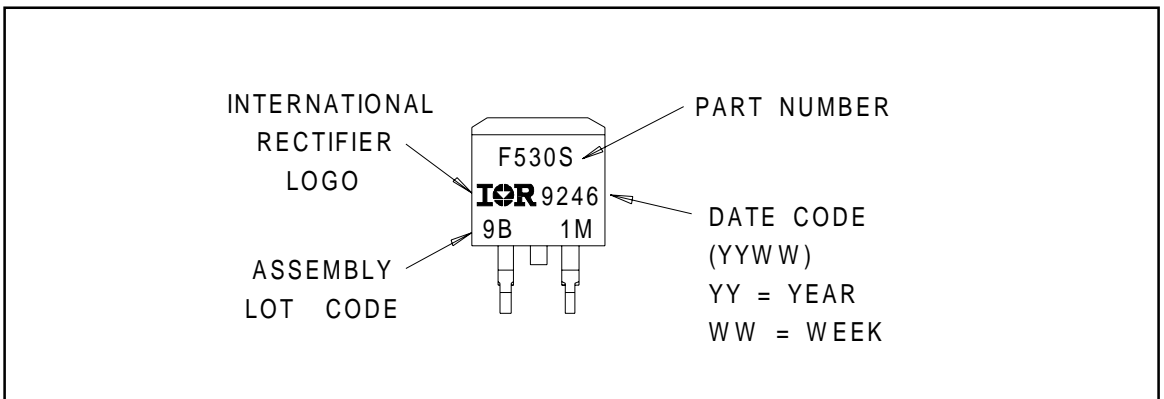

Package Outline

TO-262 Outline

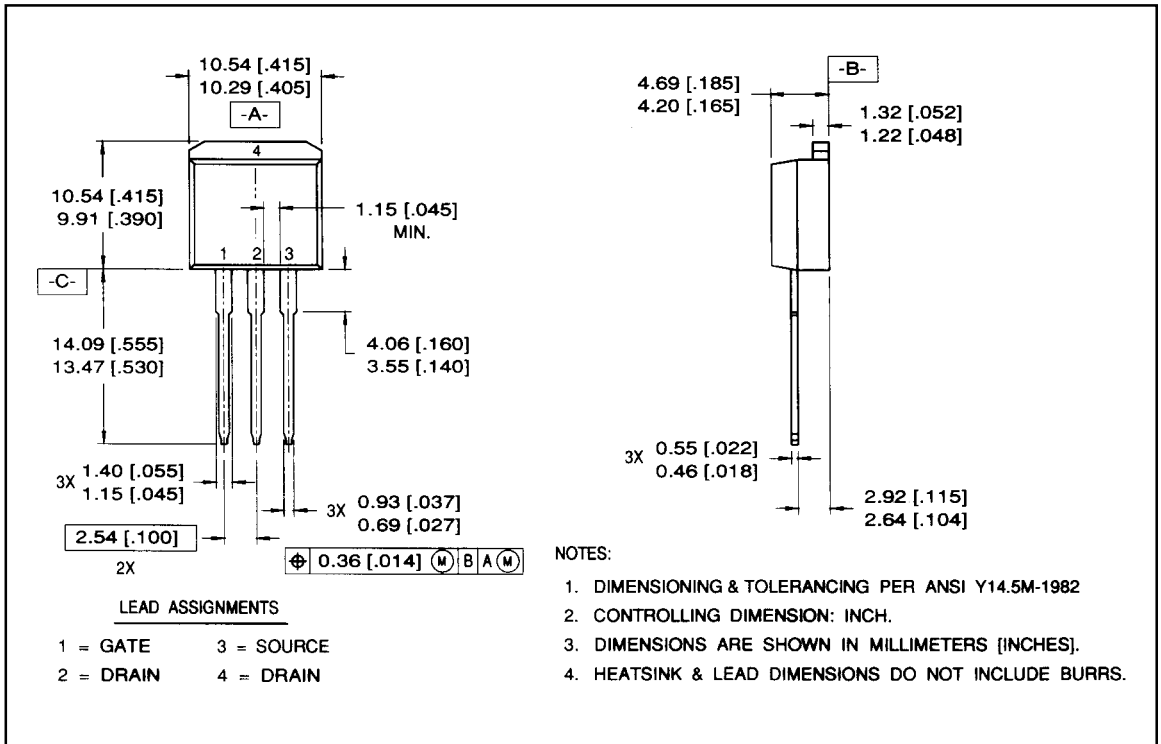

Part Marking Information

TO-262

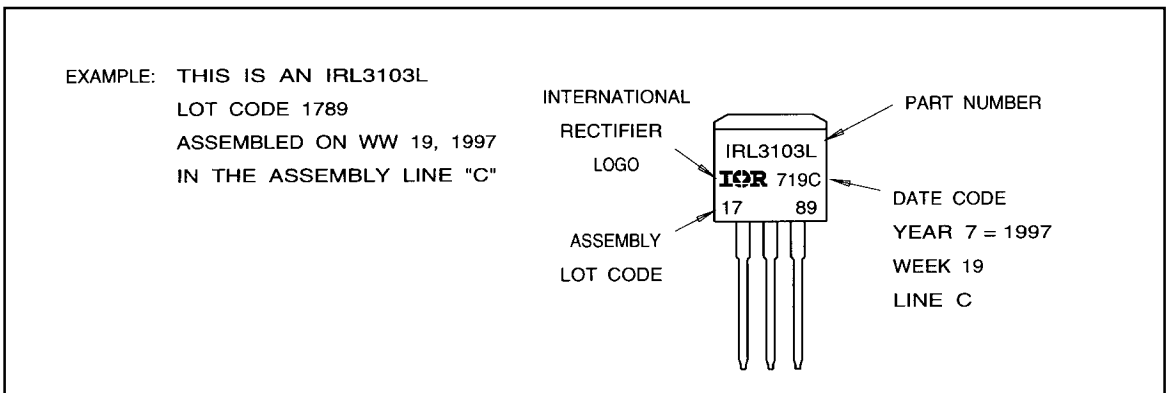

IRFZ44ES/L

Tape & Reel Information

D²Pak

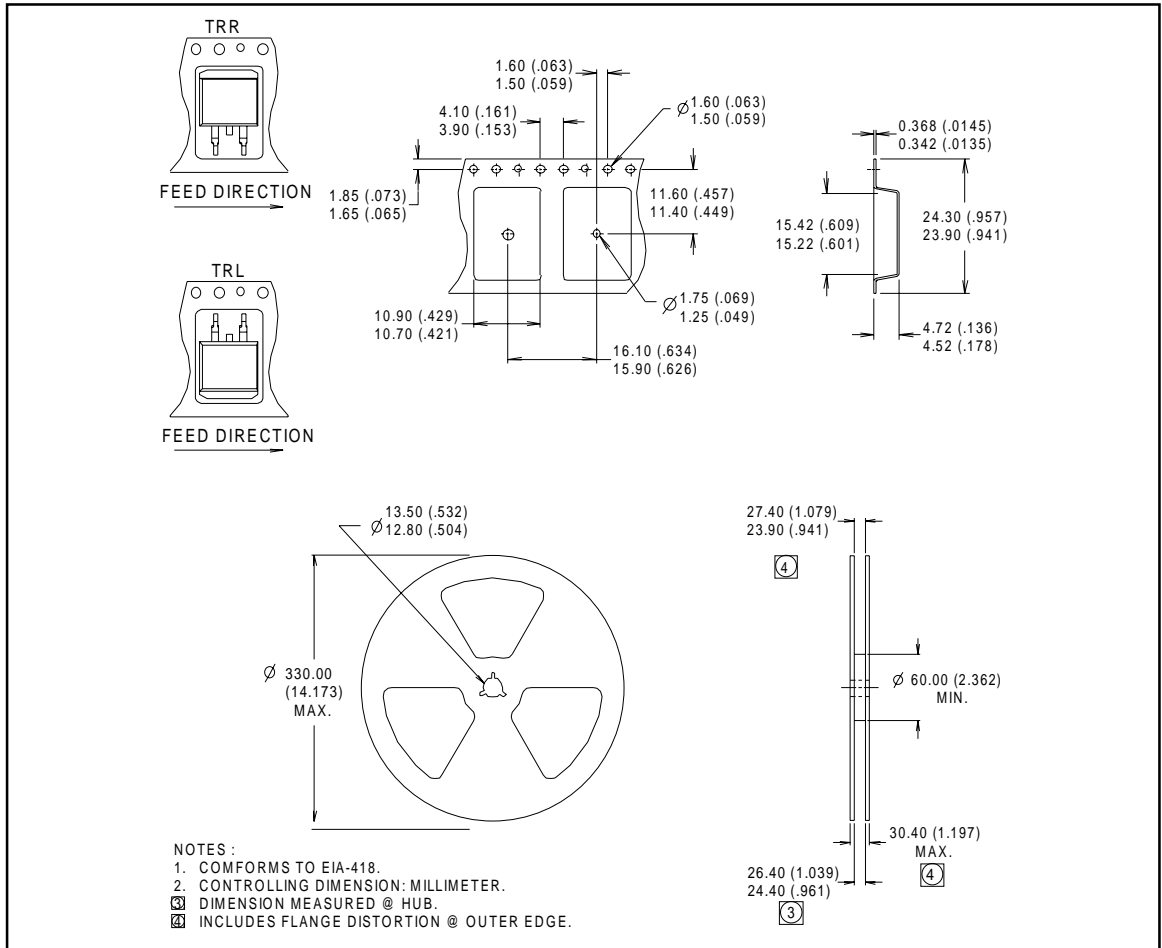

WORLD HEADQUARTERS: 233 Kansas St., El Segundo, California 90245, Tel: (310) 322 3331

EUROPEAN HEADQUARTERS: Hurst Green, Oxted, Surrey RH8 9BB, UK Tel: ++ 44 1883 732020

IR CANADA: 7321 Victoria Park Ave., Suite 201, Markham, Ontario L3R 2Z8, Tel: (905) 475 1897

IR GERMANY: Saalburgstrasse 157, 61350 Bad Homburg Tel: ++ 49 6172 96590

IR ITALY: Via Liguria 49, 10071 Borgaro, Torino Tel: ++ 39 11 451 0111

IR FAR EAST: K&H Bldg., 2F, 30-4 Nishi-Ikebukuro 3-Chome, Toshima-Ku, Tokyo Japan 171 Tel: 81 3 3983 0086

IR SOUTHEAST ASIA: 315 Outram Road, #10-02 Tan Boon Liat Building, Singapore 0316 Tel: 65 221 8371

<http://www.irf.com/> Data and specifications subject to change without notice. 11/97