

RFP2N12, RFP2N15

**2A, 120V and 150V, 1.750 Ohm,
N-Channel Power MOSFETs**

September 1998

Features

- 2A, 120V and 150V
- $r_{DS(ON)} = 1.750\Omega$
- Related Literature
 - TB334 "Guidelines for Soldering Surface Mount Components to PC Boards"

Ordering Information

PART NUMBER	PACKAGE	BRAND
RFP2N12	TO-220AB	RFP2N12
RFP2N15	TO-220AB	RFP2N15

NOTE: When ordering, include the entire part number.

Description

These are N-Channel enhancement mode silicon gate power field effect transistors designed for applications such as switching regulators, switching converters, motor drivers, relay drivers and drivers for high power bipolar switching transistors requiring high speed and low gate drive power. These types can be operated directly from integrated circuits.

Formerly developmental type TA09196.

Symbol

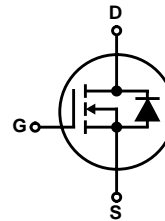

Packaging

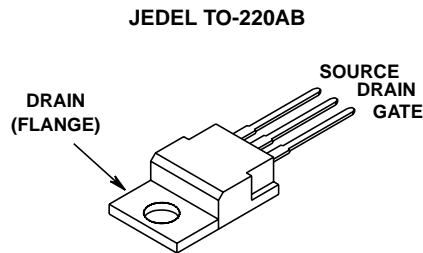

RFP2N12, RFP2N15

Absolute Maximum Ratings $T_C = 25^\circ\text{C}$, Unless Otherwise Specified

	RFP2N12	RFP2N15	UNITS	
Drain to Source Voltage (Note 1)	V_{DS}	120	150	V
Drain to Gate Voltage ($R_{GS} = 20k\Omega$) (Note 1)	V_{DGR}	120	150	V
Continuous Drain Current	I_D	2	2	A
Pulsed Drain Current (Note 3)	I_{DM}	5	5	A
Gate to Source Voltage	V_{GS}	± 20	± 20	V
Maximum Power Dissipation	P_D	25	25	W
Linear Derating Factor		0.2	0.2	W/ $^\circ\text{C}$
Operating and Storage Temperature	T_J, T_{STG}	-55 to 150	-55 to 150	$^\circ\text{C}$
Maximum Temperature for Soldering				
Leads at 0.063in (1.6mm) from Case for 10s	T_L	300	300	$^\circ\text{C}$
Package Body for 10s, See Techbrief 334	T_{pkg}	260	260	$^\circ\text{C}$

CAUTION: Stresses above those listed in "Absolute Maximum Ratings" may cause permanent damage to the device. This is a stress only rating and operation of the device at these or any other conditions above those indicated in the operational sections of this specification is not implied.

NOTE:

- $T_J = 25^\circ\text{C}$ to 125°C .

Electrical Specifications $T_C = 25^\circ\text{C}$, Unless Otherwise Specified

PARAMETER	SYMBOL	TEST CONDITIONS	MIN	TYP	MAX	UNITS	
Drain to Source Breakdown Voltage	BV_{DSS}	$I_D = 250\mu\text{A}, V_{GS} = 0\text{V}$	RFP2N12	120	-	-	V
			RFP2N15	150	-	-	V
Gate Threshold Voltage	$V_{GS(TH)}$	$V_{GS} = V_{DS}, I_D = 250\mu\text{A}$, (Figure 8)	2	-	4	V	
Zero-Gate Voltage Drain Current	I_{DSS}	$V_{DS} = \text{Rated } BV_{DSS}, V_{GS} = 0\text{V}$	-	-	1	μA	
		$V_{DS} = 0.8 \times \text{Rated } BV_{DSS}, V_{GS} = 0\text{V}, T_C = 125^\circ\text{C}$	-	-	25	μA	
Gate to Source Leakage Current	I_{GSS}	$V_{GS} = \pm 20\text{V}, V_{DS} = 0\text{V}$	-	-	± 100	nA	
Drain to Source On Resistance (Note 2)	$r_{DS(ON)}$	$I_D = 2\text{A}, V_{GS} = 10\text{V}$ (Figures 6, 7)	-	-	1.750	Ω	
Drain to Source On Voltage	$V_{DS(ON)}$	$I_D = 2\text{A}, V_{GS} = 10\text{V}$	-	-	3.5	V	
Turn-On Delay Time	$t_{d(ON)}$	$I_D \approx 1\text{A}, V_{DD} = 75\text{V}, R_G = 50\Omega,$ $R_L = 73\Omega, V_{GS} = 10\text{V}$ (Figures 10, 11, 12)	-	17	25	ns	
Rise Time	t_r		-	30	45	ns	
Turn-Off Delay Time	$t_{d(OFF)}$		-	30	45	ns	
Fall Time	t_f		-	17	25	ns	
Input Capacitance	C_{ISS}	$V_{GS} = 0\text{V}, V_{DS} = 25\text{V}$ $f = 1\text{MHz}$, (Figure 9)	-	-	200	pF	
Output Capacitance	C_{OSS}		-	-	80	pF	
Reverse-Transfer Capacitance	C_{RSS}		-	-	25	pF	
Thermal Resistance Junction to Case	$R_{\theta JC}$		-	-	5	$^\circ\text{C/W}$	

Source to Drain Diode Specifications

PARAMETER	SYMBOL	TEST CONDITIONS	MIN	TYP	MAX	UNITS
Source to Drain Diode Voltage (Note 2)	V_{SD}	$I_{SD} = -1\text{A}$	-	-	1.4	V
Diode Reverse Recovery Time	t_{rr}	$I_{SD} = 2\text{A}, dI_{SD}/dt = 50\text{A}/\mu\text{s}$	-	150	-	ns

NOTES:

- Pulsed test: Pulse width $\leq 300\mu\text{s}$ duty cycle $\leq 2\%$.
- Repetitive rating: pulse width limited by maximum junction temperature.

Typical Performance Curves Unless Otherwise Specified

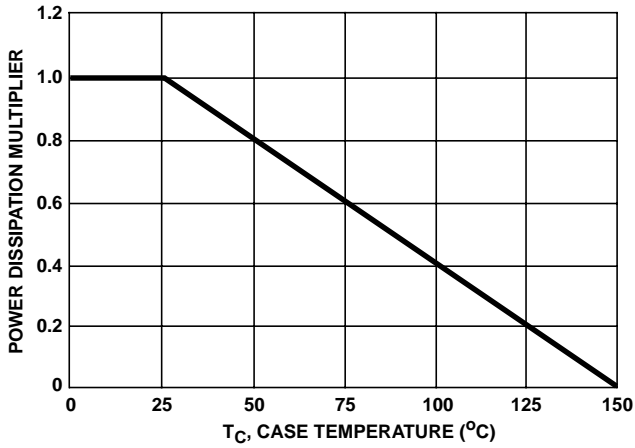

FIGURE 1. NORMALIZED POWER DISSIPATION vs CASE TEMPERATURE

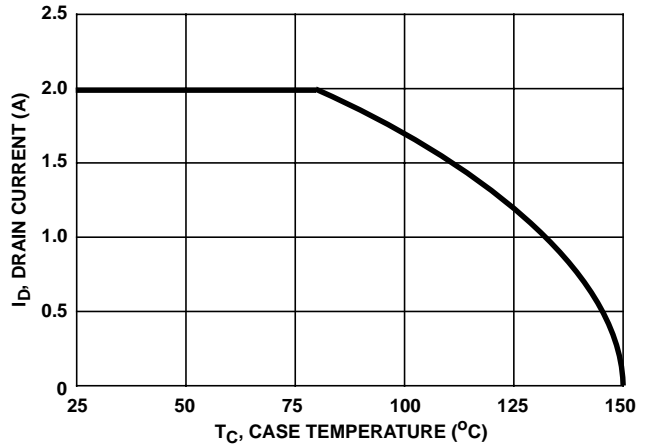

FIGURE 2. MAXIMUM CONTINUOUS DRAIN CURRENT vs CASE TEMPERATURE

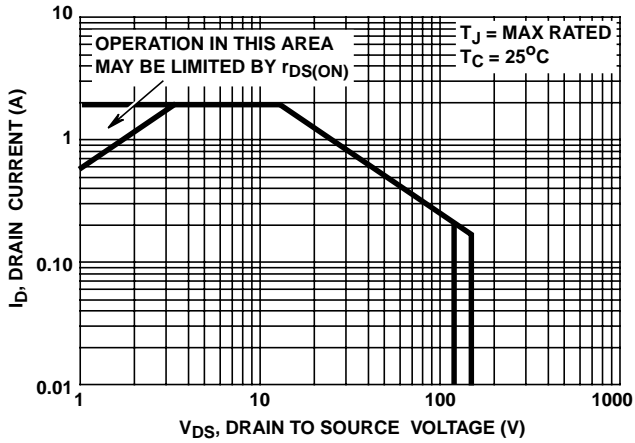

FIGURE 3. FORWARD BIAS OPERATING AREA

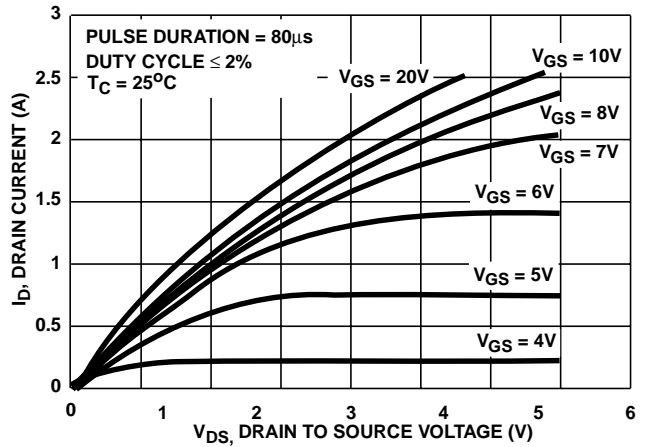

FIGURE 4. SATURATION CHARACTERISTICS

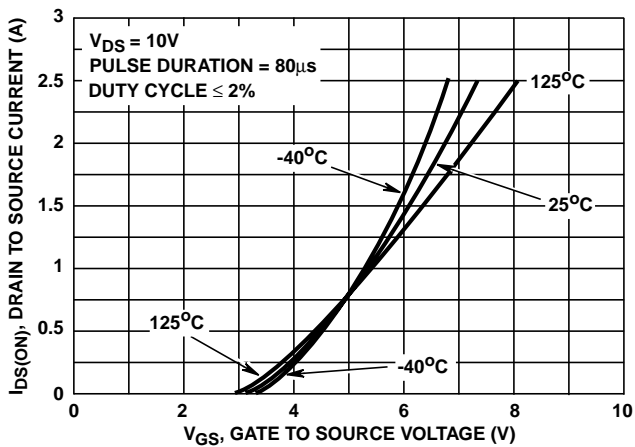

FIGURE 5. TRANSFER CHARACTERISTICS

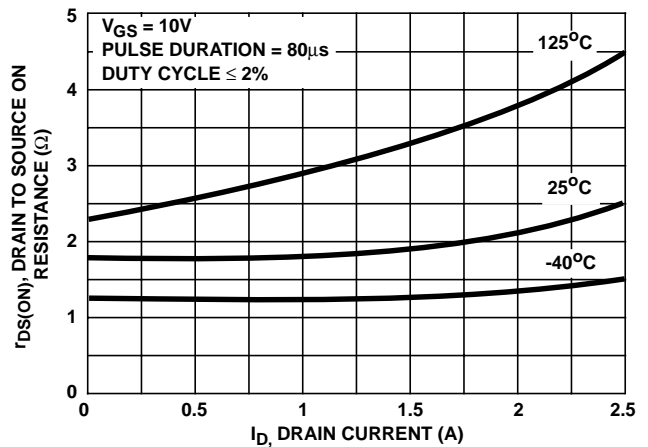

FIGURE 6. DRAIN TO SOURCE ON RESISTANCE vs DRAIN CURRENT

Typical Performance Curves Unless Otherwise Specified (Continued)

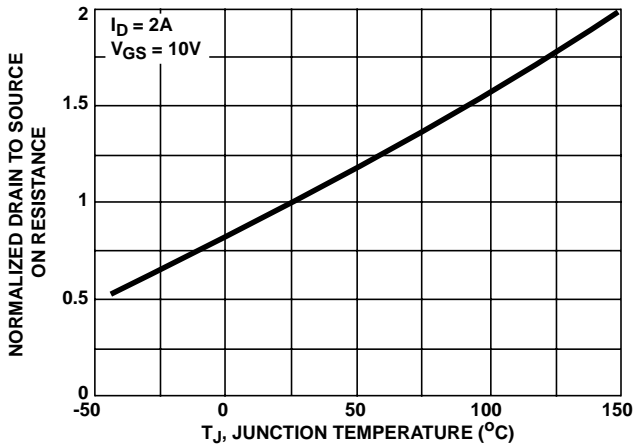

FIGURE 7. NORMALIZED DRAIN TO SOURCE ON RESISTANCE vs JUNCTION TEMPERATURE

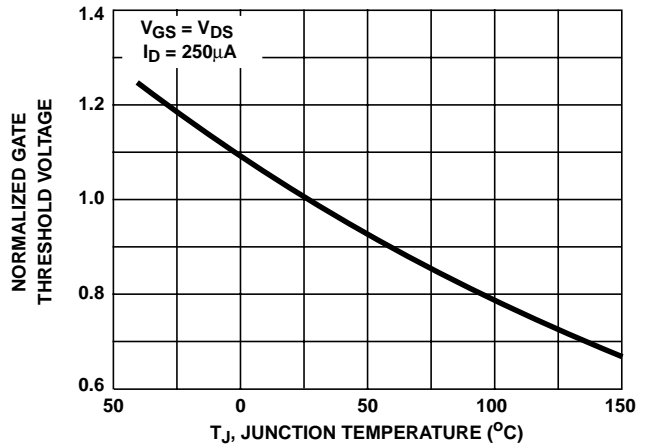

FIGURE 8. NORMALIZED GATE THRESHOLD VOLTAGE vs JUNCTION TEMPERATURE

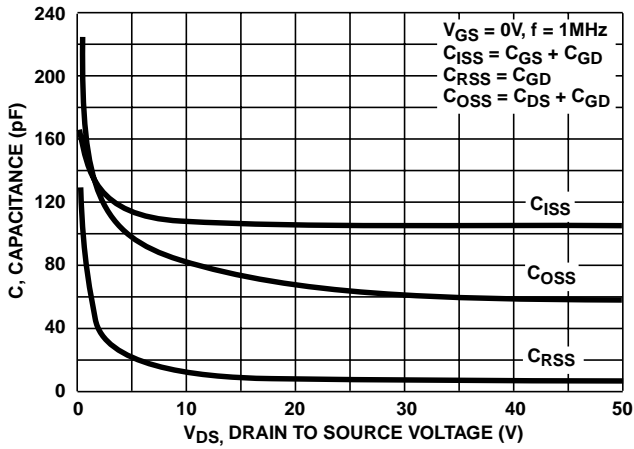
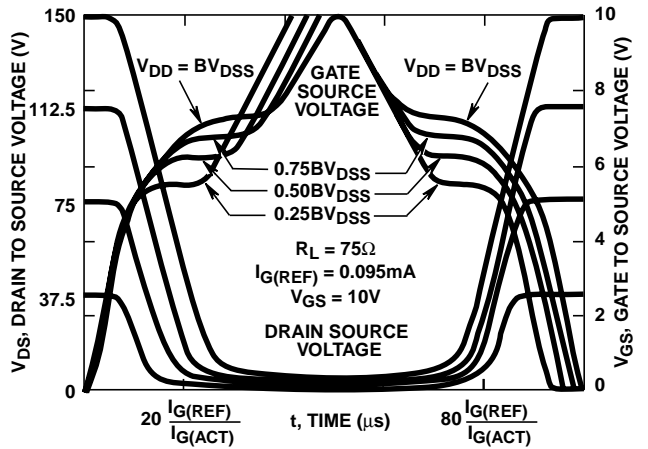

FIGURE 9. CAPACITANCE vs DRAIN TO SOURCE VOLTAGE



NOTE: Refer to Harris Applications Notes AN7254 and AN7260

FIGURE 10. NORMALIZED SWITCHING WAVEFORMS FOR CONSTANT GATE CURRENT

Test Circuits and Waveforms

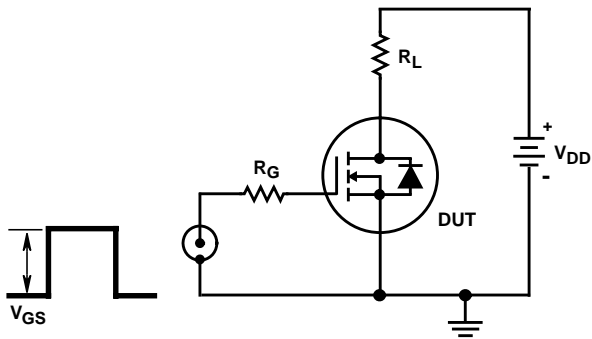

FIGURE 11. SWITCHING TIME TEST CIRCUIT

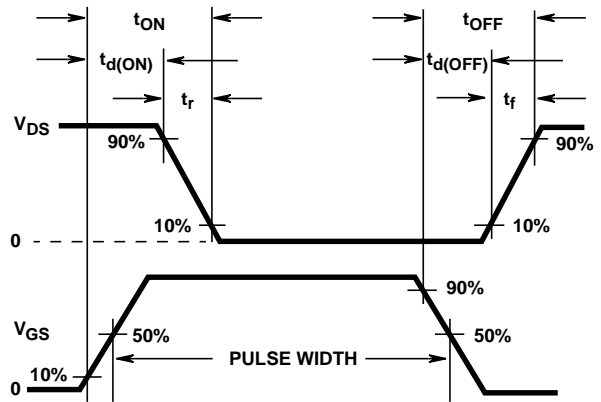

FIGURE 12. RESISTIVE SWITCHING WAVEFORMS

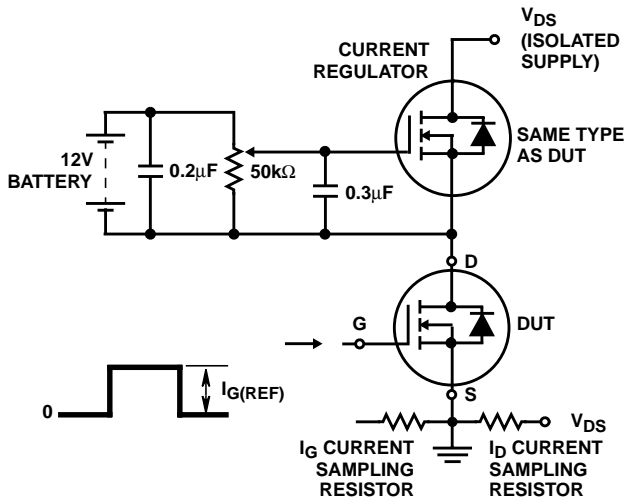

FIGURE 13. GATE CHARGE TEST CIRCUIT

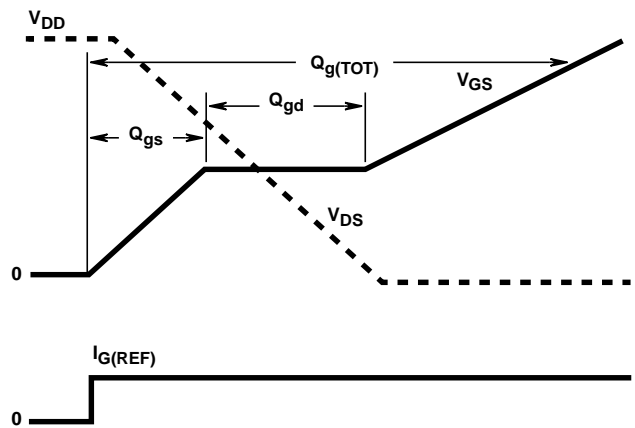

FIGURE 14. GATE CHARGE WAVEFORMS