

2A, 80V and 100V, 1.050 Ohm, Logic Level, N-Channel Power MOSFETs

The RFP2N08L and RFP2N10L are N-Channel enhancement mode silicon gate power field effect transistors specifically designed for use with logic level (5V) driving sources in applications such as programmable controllers, automotive switching, and solenoid drivers. This performance is accomplished through a special gate oxide design which provides full rated conductance at gate biases in the 3V to 5V range, thereby facilitating true on-off power control directly from logic circuit supply voltages.

Formerly developmental type TA0924.

Ordering Information

PART NUMBER	PACKAGE	BRAND
RFP2N08L	TO-220AB	RFP2N08L
RFP2N10L	TO-220AB	RFP2N10L

NOTE: When ordering, include the entire part number.

Features

- 2A, 80V and 100V
- $r_{DS(ON)} = 1.050\Omega$
- Design Optimized for 5V Gate Drives
- Can be Driven Directly from QMOS, NMOS, TTL Circuits
- Compatible with Automotive Drive Requirements
- SOA is Power Dissipation Limited
- Nanosecond Switching Speeds
- Linear Transfer Characteristics
- High Input Impedance
- Majority Carrier Device
- Related Literature
 - TB334 "Guidelines for Soldering Surface Mount Components to PC Boards"

Symbol

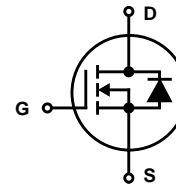

Packaging

JEDEC TO-220AB

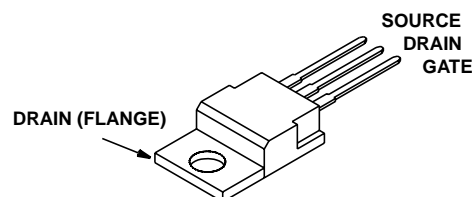

RFP2N08L, RFP2N10L

Absolute Maximum Ratings $T_C = 25^\circ\text{C}$, Unless Otherwise Specified

	RFP2N08L	RFP2N10L	UNITS	
Drain to Source Voltage (Note 1)	V_{DS}	80	100	V
Drain to Gate Voltage ($R_{GS} = 1\text{M}\Omega$) (Note 1)	V_{DGR}	80	100	V
Continuous Drain Current	I_D	2	2	A
Pulsed Drain Current (Note 3)	I_{DM}	5	5	A
Gate to Source Voltage	V_{GS}	± 10	± 10	V
Maximum Power Dissipation	P_D	25	25	W
Derate above 25°C		0.2	0.2	W/ $^\circ\text{C}$
Operating and Storage Temperature	T_J, T_{STG}	-55 to 150	-55 to 150	$^\circ\text{C}$
Maximum Temperature for Soldering				
Leads at 0.063in (1.6mm) from Case for 10s	T_L	300	300	$^\circ\text{C}$
Package Body for 10s, See Techbrief 334	T_{pkg}	260	260	$^\circ\text{C}$

CAUTION: Stresses above those listed in "Absolute Maximum Ratings" may cause permanent damage to the device. This is a stress only rating and operation of the device at these or any other conditions above those indicated in the operational sections of this specification is not implied.

NOTE:

- $T_J = 25^\circ\text{C}$ to 125°C .

Electrical Specifications $T_C = 25^\circ\text{C}$, Unless Otherwise Specified

PARAMETER	SYMBOL	TEST CONDITIONS	MIN	TYP	MAX	UNITS
Drain to Source Breakdown Voltage RFP2N08L	BV_{DSS}	$V_{GS} = 0\text{V}, I_D = 250\mu\text{A}$	80	-	-	V
			RFP2N10L	100	-	-
Gate to Threshold Voltage	$V_{GS(TH)}$	$V_{GS} = V_{DS}, I_D = 250\mu\text{A}$	1.0	-	2.0	V
Gate to Source Leakage	I_{GSS}	$V_{GS} = \pm 10\text{V}, V_{DS} = 0\text{V}$	-	-	± 100	nA
Zero to Gate Voltage Drain Current	I_{DSS}	$V_{DS} = \text{Rated } BV_{DSS}, V_{GS} = 0\text{V}$	-	-	1.0	μA
		$V_{DS} = 0.8 \times \text{Rated } BV_{DSS}, V_{GS} = 0\text{V}, T_C = 125^\circ\text{C}$	-	-	25	μA
Drain to Source On Voltage (Note 2)	$V_{DS(ON)}$	$I_D = 2\text{A}, V_{GS} = 5\text{V}$	-	-	2.1	V
Drain to Source On Resistance (Note 2)	$r_{DS(ON)}$	$I_D = 2\text{A}, V_{GS} = 5\text{V}$, (Figures 6, 7)	-	-	1.050	Ω
Turn-On Delay Time	$t_{d(ON)}$	$I_D = 2\text{A}, V_{DD} = 50\text{V}, R_G = 6.25\Omega,$ $R_L = 25\Omega, V_{GS} = 5\text{V}$ (Figures 10, 11, 12)	-	10	25	ns
Rise Time	t_r		-	15	45	ns
Turn-Off Delay Time	$t_{d(OFF)}$		-	25	45	ns
Fall Time	t_f		-	20	25	ns
Input Capacitance	C_{ISS}	$V_{GS} = 0\text{V}, V_{DS} = 25\text{V}, f = 1.0\text{MHz}$ (Figure 9)	-	-	200	pF
Output Capacitance	C_{OSS}		-	-	80	pF
Reverse Transfer Capacitance	C_{RSS}		-	-	35	pF
Thermal Resistance Junction to Case	$R_{\theta JC}$		-	-	5	$^\circ\text{C/W}$

Source to Drain Diode Specifications

PARAMETER	SYMBOL	TEST CONDITIONS	MIN	TYP	MAX	UNITS
Source to Drain Diode Voltage (Note 2)	V_{SD}	$I_{SD} = 2\text{A}$	-	-	1.4	V
Reverse Recovery Time	t_{rr}	$I_{SD} = 2\text{A}, dI_{SD}/dt = 50\text{A}/\mu\text{s}$	-	100	-	ns

NOTES:

- Pulse test: pulse width $\leq 300\mu\text{s}$, duty cycle $\leq 2\%$.
- Repetitive rating: pulse width limited by maximum junction temperature.

Typical Performance Curves Unless Otherwise Specified

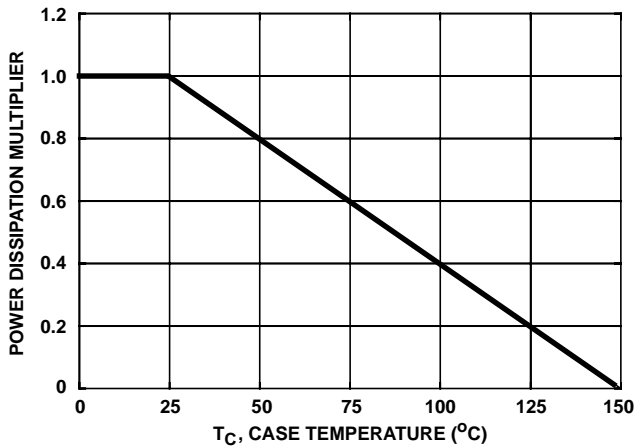

FIGURE 1. NORMALIZED POWER DISSIPATION vs CASE TEMPERATURE

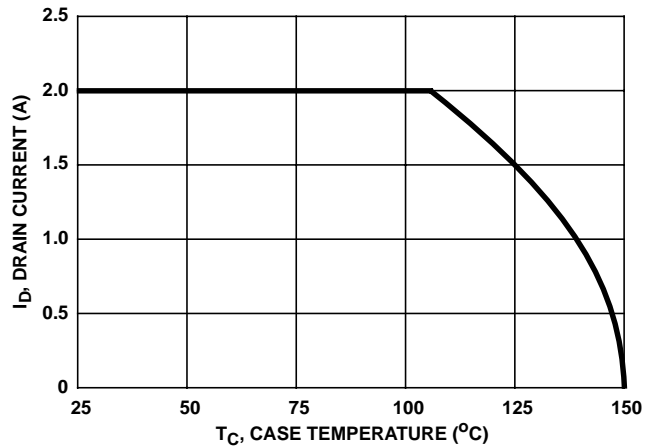

FIGURE 2. MAXIMUM CONTINUOUS DRAIN CURRENT vs CASE TEMPERATURE

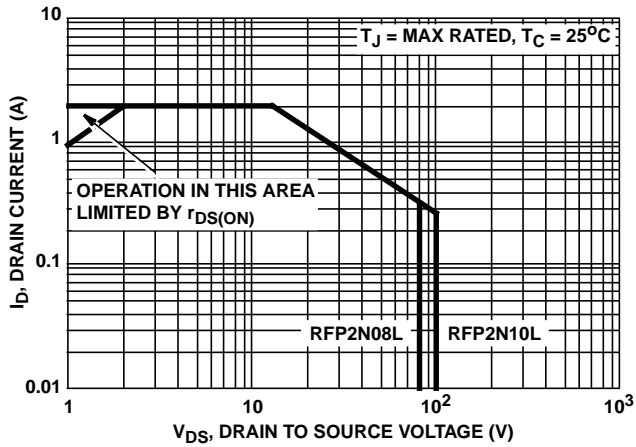

FIGURE 3. FORWARD BIAS SAFE OPERATING AREA

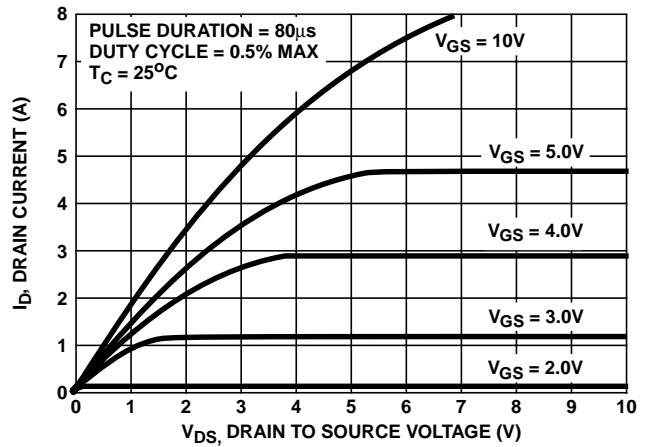

FIGURE 4. SATURATION CHARACTERISTICS

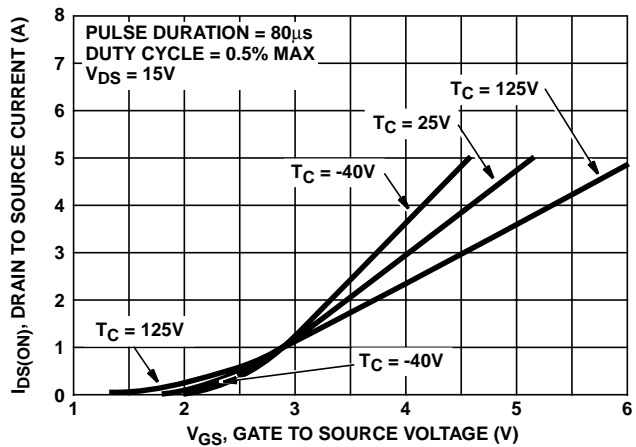

FIGURE 5. TRANSFER CHARACTERISTICS

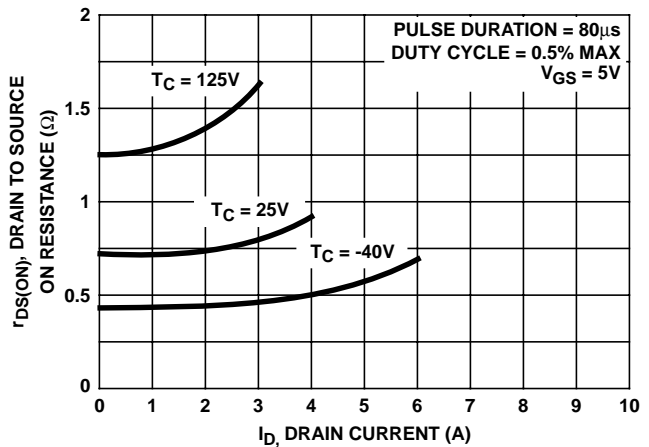

FIGURE 6. DRAIN TO SOURCE ON RESISTANCE vs DRAIN CURRENT

Typical Performance Curves Unless Otherwise Specified (Continued)

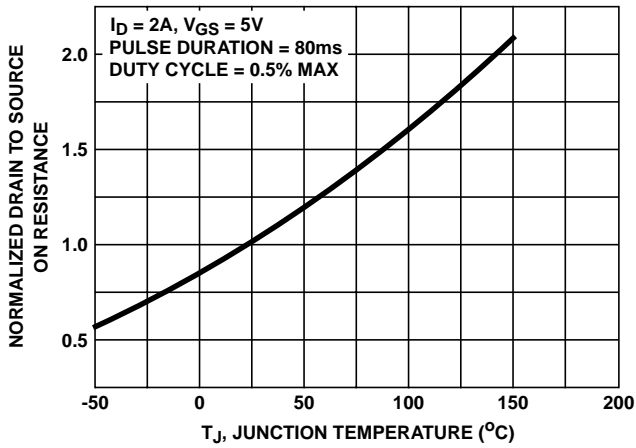

FIGURE 7. NORMALIZED DRAIN TO SOURCE ON RESISTANCE vs JUNCTION TEMPERATURE

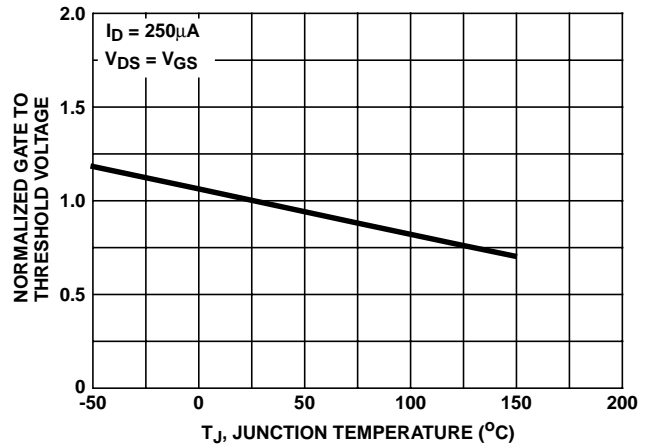

FIGURE 8. NORMALIZED GATE TO THRESHOLD vs JUNCTION TEMPERATURE

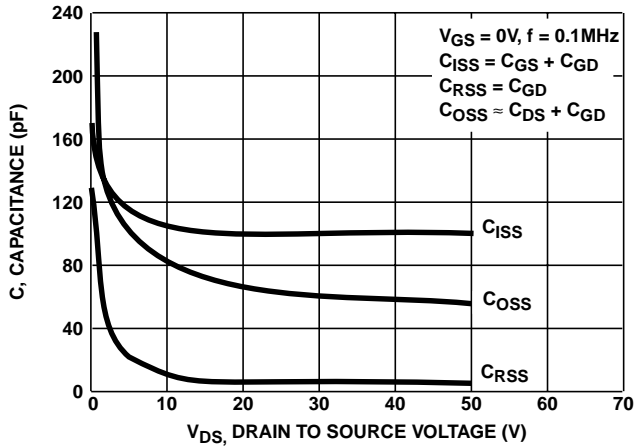
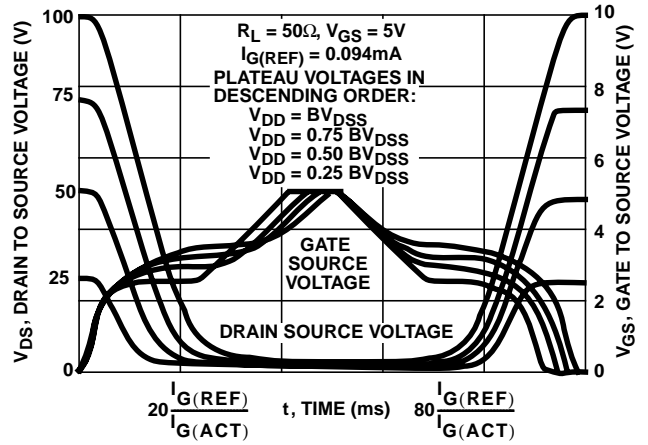

FIGURE 9. CAPACITANCE vs DRAIN TO SOURCE VOLTAGE



NOTE: Refer to Intersil Application Notes AN7254 and AN7260.

FIGURE 10. NORMALIZED SWITCHING WAVEFORMS FOR CONSTANT GATE CURRENT

Test Circuit and Waveforms

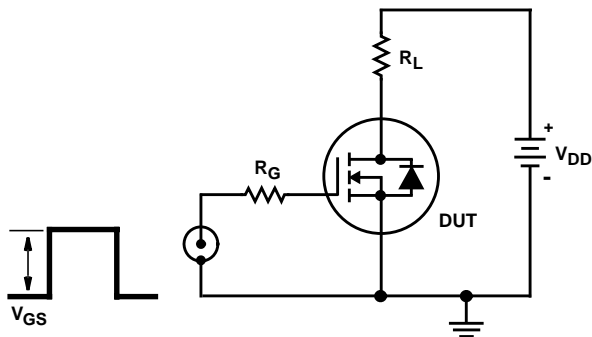

FIGURE 11. SWITCHING TIME TEST CIRCUIT

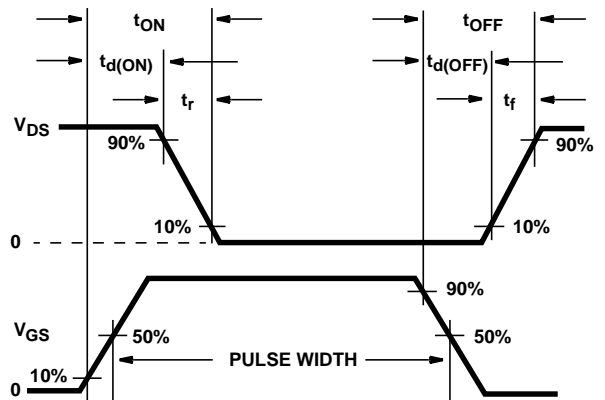

FIGURE 12. RESISTIVE SWITCHING WAVEFORMS

All Intersil semiconductor products are manufactured, assembled and tested under **ISO9000** quality systems certification.

Intersil semiconductor products are sold by description only. Intersil Corporation reserves the right to make changes in circuit design and/or specifications at any time without notice. Accordingly, the reader is cautioned to verify that data sheets are current before placing orders. Information furnished by Intersil is believed to be accurate and reliable. However, no responsibility is assumed by Intersil or its subsidiaries for its use; nor for any infringements of patents or other rights of third parties which may result from its use. No license is granted by implication or otherwise under any patent or patent rights of Intersil or its subsidiaries.

For information regarding Intersil Corporation and its products, see web site <http://www.intersil.com>

Sales Office Headquarters

NORTH AMERICA

Intersil Corporation
P. O. Box 883, Mail Stop 53-204
Melbourne, FL 32902
TEL: (407) 724-7000
FAX: (407) 724-7240

EUROPE

Intersil SA
Mercure Center
100, Rue de la Fusee
1130 Brussels, Belgium
TEL: (32) 2.724.2111
FAX: (32) 2.724.22.05

ASIA

Intersil (Taiwan) Ltd.
7F-6, No. 101 Fu Hsing North Road
Taipei, Taiwan
Republic of China
TEL: (886) 2 2716 9310
FAX: (886) 2 2715 3029