

CMOS Analog Switches

The HI-301 thru HI-307 series of switches are monolithic devices fabricated using CMOS technology and the Intersil dielectric isolation process. These switches feature break before-make switching, low and nearly constant ON resistance over the full analog signal range, and low power dissipation, (a few mW for the HI-301 and HI-303, a few hundred mW for the HI-307).

The HI-301 and HI-303 are TTL compatible and have a logic "0" condition with an input less than 0.8V and a logic "1" condition with an input greater than 4V. The HI-307 switches are CMOS compatible and have a low state with an input less than 3.5V and a high state with an input greater than 11V. (See pinouts for switch conditions with a logic "1" input.)

Ordering Information

PART NUMBER	TEMP. RANGE (°C)	PACKAGE	PKG. NO.
HI9P0301-5	0 to 75	14 Ld SOIC	M14.15
HI1-0303-2	-55 to 125	14 Ld CERDIP	F14.3
HI1-0303-5	0 to 75	14 Ld CERDIP	F14.3
HI9P0303-5	0 to 75	14 Ld SOIC	M14.15
HI9P0303-9	-40 to 85	14 Ld SOIC	M14.15
HI1-0307-5	0 to 75	14 Ld CERDIP	F14.3

Features

- Analog Signal Range ($\pm 15V$ Supplies) $\pm 15V$
- Low Leakage at 25°C 40pA
- Low Leakage at 125°C 1nA
- Low On Resistance at 25°C 35 Ω
- Break-Before-Make Delay 60ns
- Charge Injection 30pC
- TTL, CMOS Compatible
- Symmetrical Switch Elements
- Low Operating Power (Typ for HI-301 and HI-303) . . 1.0mW

Applications

- Sample and Hold (i.e., Low Leakage Switching)
- Op Amp Gain Switching (i.e., Low On Resistance)
- Portable, Battery Operated Circuits
- Low Level Switching Circuits
- Dual or Single Supply Systems

Functional Diagram

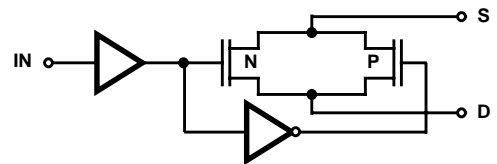

Pinouts Switch States Shown For A Logic "1" Input

SPST HI-301 (SOIC) TOP VIEW

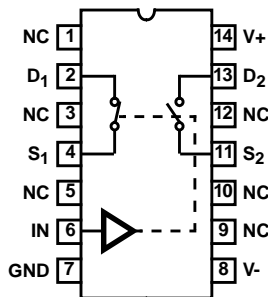

LOGIC	SW1	SW2
0	OFF	ON
1	ON	OFF

DUAL SPDT HI-303 (CERDIP, SOIC) HI-307 (CERDIP) TOP VIEW

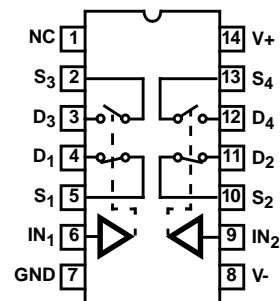

LOGIC	SW1, SW2	SW3, SW4
0	OFF	ON
1	ON	OFF

HI-301 thru HI-307

Electrical Specifications Supplies = +15V, -15V; V_{IN} = Logic Input. HI-301 and HI-303: V_{IN} - for Logic "1" = 4V, for Logic "0" = 0.8V. HI-307: V_{IN} - for Logic "1" = 11V, for Logic "0" = 3.5V, Unless Otherwise Specified **(Continued)**

PARAMETER	TEMP (°C)	-2			-5, -9			UNITS
		MIN	TYP	MAX	MIN	TYP	MAX	
OFF Output Leakage Current, $I_{D(OFF)}$ (Note 3)	25	-	0.04	1	-	0.04	5	nA
	Full	-	1	100	-	0.2	100	nA
ON Leakage Current, $I_{D(ON)}$ (Note 4)	25	-	0.03	1	-	0.03	5	nA
	Full	-	0.5	100	-	0.2	100	nA
POWER SUPPLY CHARACTERISTICS								
Current, I+ (Notes 8, 13)	25	-	0.09	0.5	-	0.09	0.5	mA
	Full	-	-	1	-	-	1	mA
Current, I- (Notes 8, 13)	25	-	0.01	10	-	0.01	100	μ A
	Full	-	-	100	-	-	-	μ A
Current, I+ (Notes 9, 13)	25	-	0.01	10	-	0.01	100	μ A
	Full	-	-	100	-	-	-	μ A
Current, I- (Notes 9, 13)	25	-	0.01	10	-	0.01	100	μ A
	Full	-	-	100	-	-	-	μ A
Current, I+ (Notes 10, 14)	25	-	0.01	10	-	0.01	100	μ A
	Full	-	-	100	-	-	-	μ A
Current, I- (Notes 10, 14)	25	-	0.01	10	-	0.01	100	μ A
	Full	-	-	100	-	-	-	μ A
Current, I+ (Notes 11, 14)	25	-	0.01	10	-	0.01	100	μ A
	Full	-	-	100	-	-	-	μ A
Current, I- (Notes 11, 14)	25	-	0.01	10	-	0.01	100	μ A
	Full	-	-	100	-	-	-	μ A

NOTES:

2. $V_S = \pm 10V$, $I_{OUT} = \mp 10mA$. On resistance derived from the voltage measured across the switch under these conditions.
3. $V_S = \pm 14V$, $V_D = \mp 14V$.
4. $V_S = V_D = \pm 14V$.
5. The digital inputs are diode protected MOS gates and typical leakages of 1nA or less can be expected.
6. $V_S = 1V_{RMS}$, $f = 500kHz$, $C_L = 15pF$, $R_L = 1K$.
7. $V_S = 0V$, $C_L = 10nF$, Logic Drive = 5V pulse (HI-301 - 303), 15V pulse (HI-307). Switches are symmetrical; S and D may be interchanged. Charge Injection = $Q = C_L \times \Delta V$.
8. $V_{IN} = 4V$ (one input, all other inputs = 0V).
9. $V_{IN} = 0.8V$ (all inputs).
10. $V_{IN} = 15V$ (all inputs).
11. $V_{IN} = 0V$ (all inputs).
12. To drive from DTL/TTL circuits, pullup resistors to +5V supply are recommended.
13. HI-301 thru HI-303 only.
14. HI-307 only.

Test Circuits and Waveforms

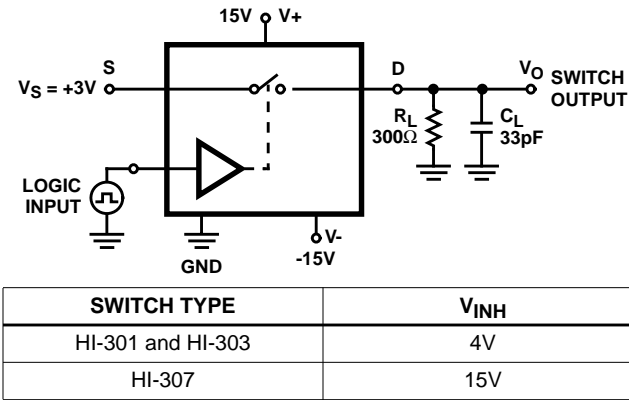

FIGURE 1A. TEST CIRCUIT

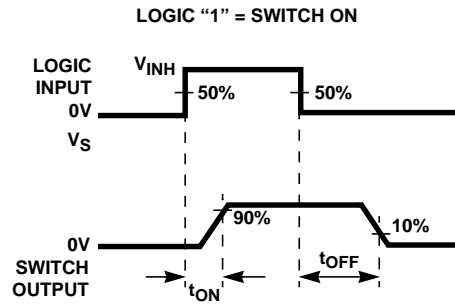

FIGURE 1B. MEASUREMENT POINTS

FIGURE 1. SWITCH t_{ON} AND t_{OFF}

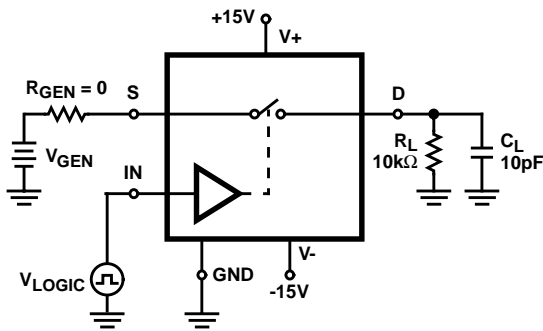

FIGURE 2A. TEST CIRCUIT

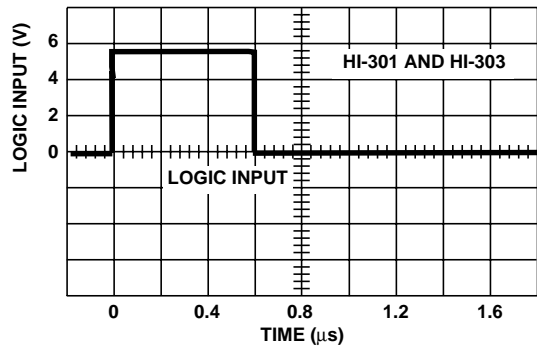

FIGURE 2B. TTL LOGIC INPUT

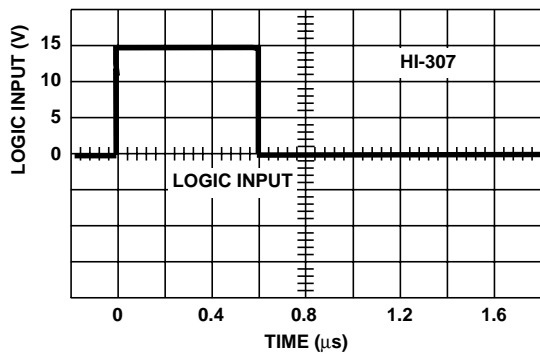

FIGURE 2C. CMOS LOGIC INPUT

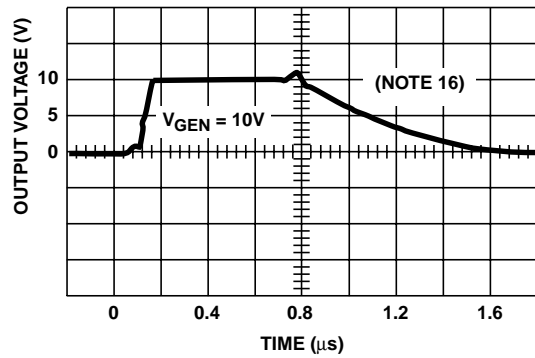

FIGURE 2D. $V_{ANALOG} = 10V$

Test Circuits and Waveforms (Continued)

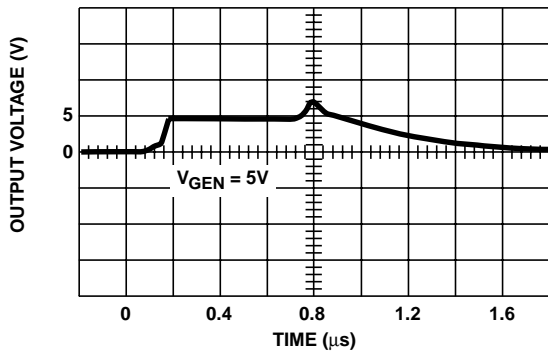

FIGURE 2E. $V_{ANALOG} = 5V$

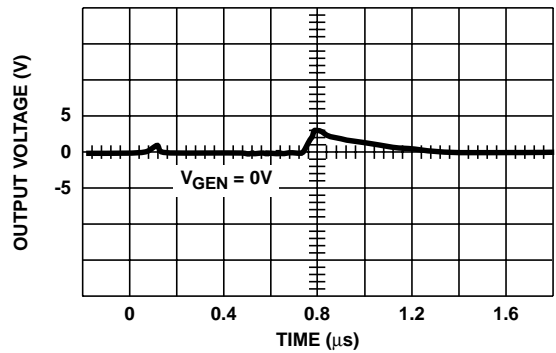

FIGURE 2F. $V_{ANALOG} = 0V$

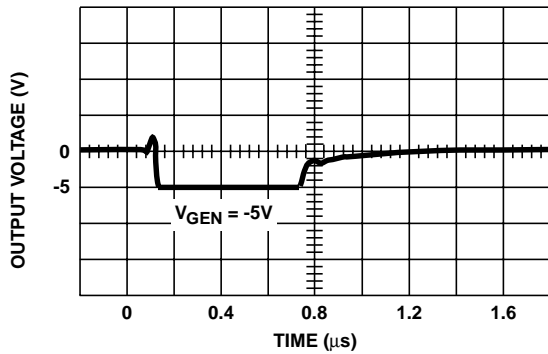

FIGURE 2G. $V_{ANALOG} = -5V$

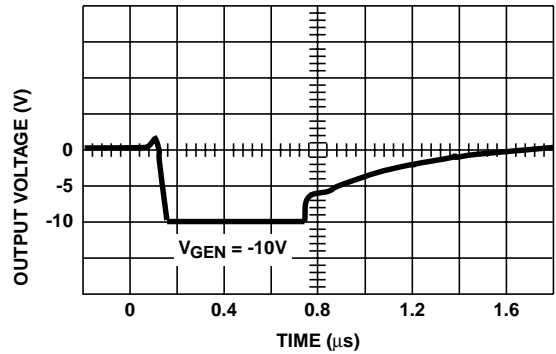
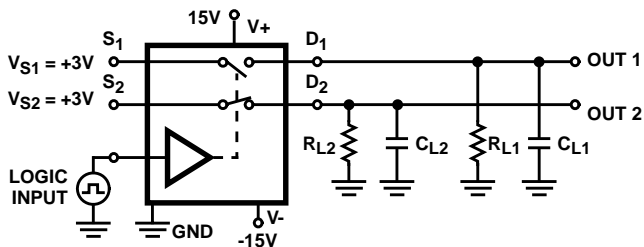

FIGURE 2H. $V_{ANALOG} = -10V$

NOTE:

15. If R_{GEN} , R_L or C_L is increased, there will be proportional increases in rise and/or fall RC times.

FIGURE 2. SWITCHING WAVEFORMS FOR VARIOUS ANALOG INPUT VOLTAGES



SWITCH TYPE	V_{INH}
HI-301, HI-303	5V
HI-307	15V

FIGURE 3A. TEST CIRCUIT

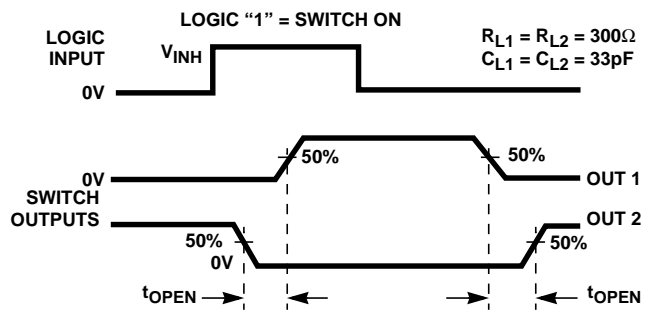

FIGURE 3B. MEASUREMENT POINTS

FIGURE 3. BREAK-BEFORE-MAKE DELAY (t_{OPEN})

Typical Performance Curves

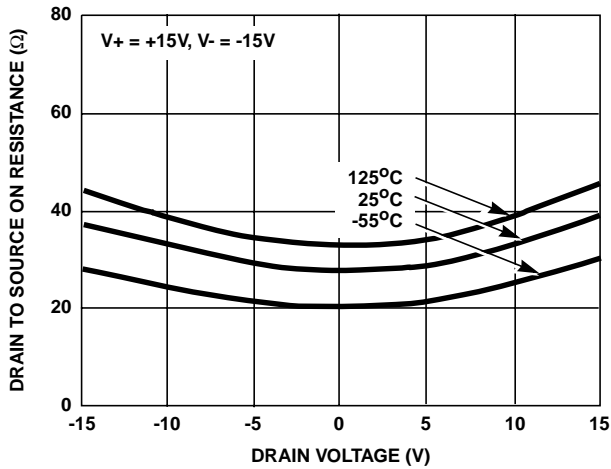

FIGURE 4. $r_{DS(ON)}$ vs V_D

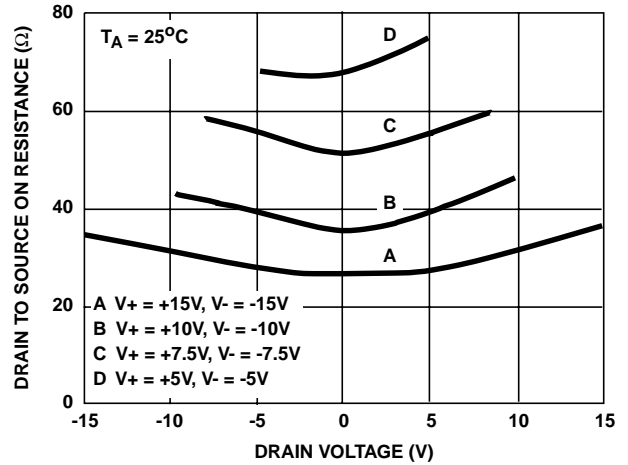

FIGURE 5. $r_{DS(ON)}$ vs V_D

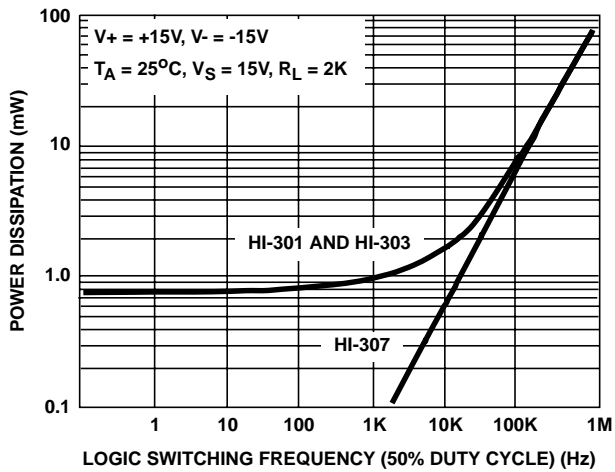

FIGURE 6. DEVICE POWER DISSIPATION vs SWITCHING FREQUENCY (SINGLE LOGIC INPUT)

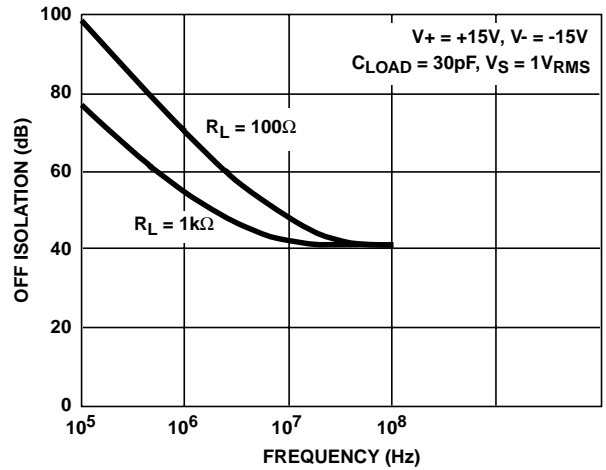

FIGURE 7. OFF ISOLATION vs FREQUENCY

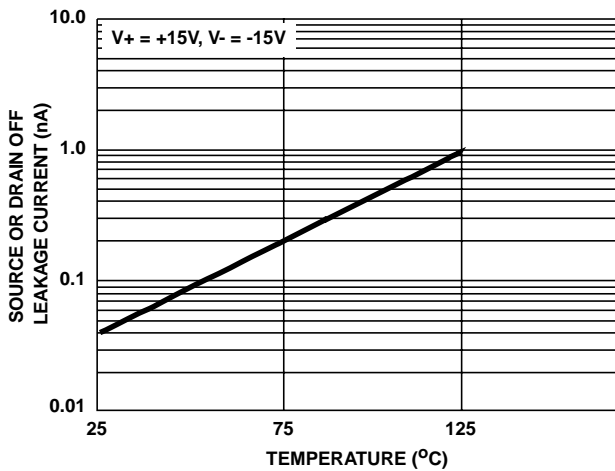

FIGURE 8. $I_{S(OFF)}$ OR $I_{D(OFF)}$ vs TEMPERATURE †

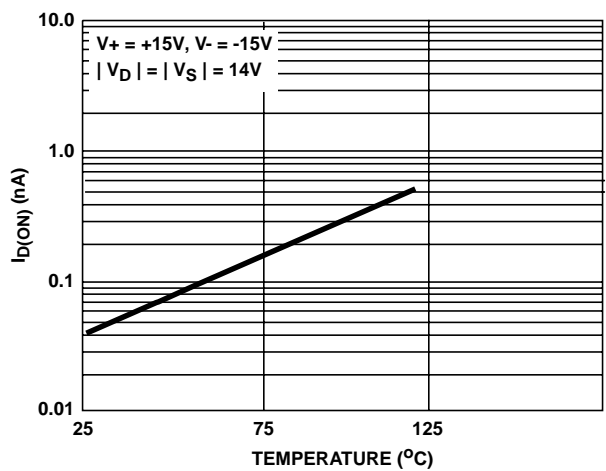

FIGURE 9. $I_{D(ON)}$ vs TEMPERATURE †

† The net leakage into the source or drain is the N-Channel leakage minus the P-Channel leakage. This difference can be positive, negative or zero depending on the analog voltage and temperature, and will vary greatly from unit to unit.

Typical Performance Curves (Continued)

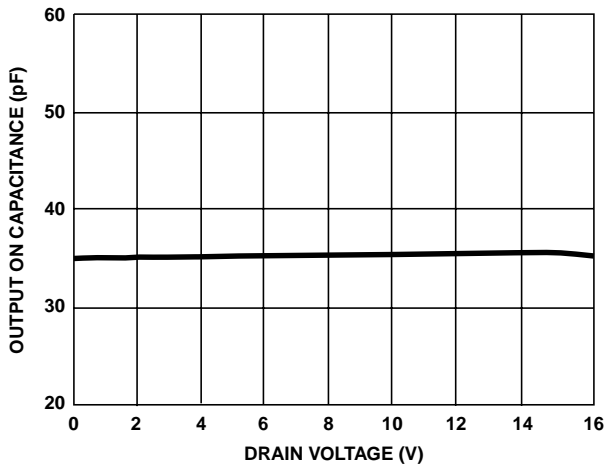

FIGURE 10. OUTPUT ON CAPACITANCE vs DRAIN VOLTAGE

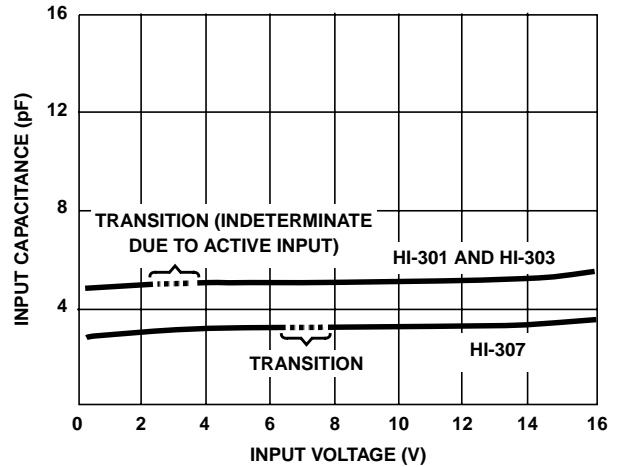

FIGURE 11. DIGITAL INPUT CAPACITANCE vs INPUT VOLTAGE

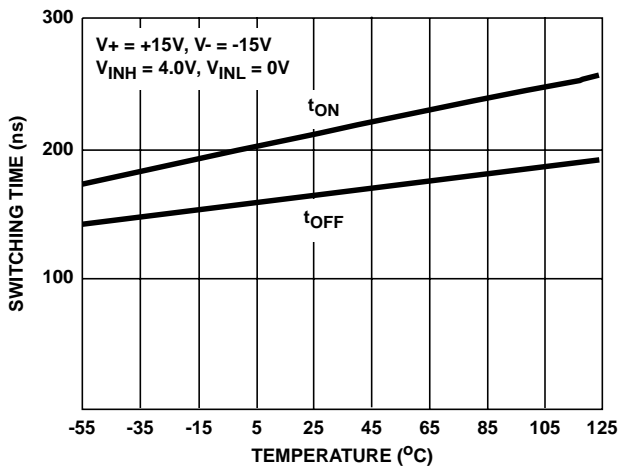

FIGURE 12. SWITCHING TIME vs TEMPERATURE, HI-301 AND HI-303

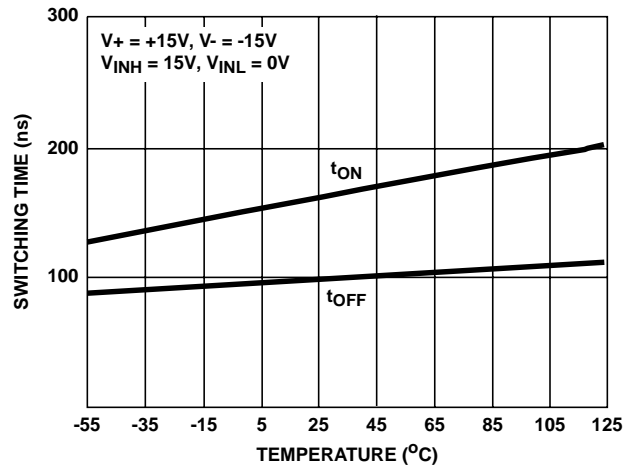

FIGURE 13. SWITCHING TIME vs TEMPERATURE, HI-307

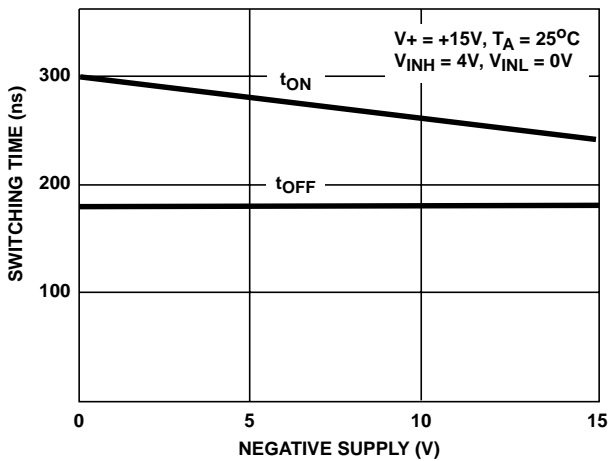

FIGURE 14. SWITCHING TIME vs NEGATIVE SUPPLY VOLTAGE, HI-301 AND HI-303

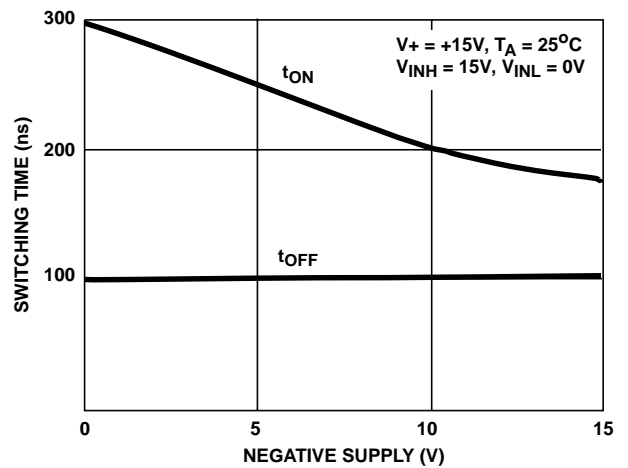

FIGURE 15. SWITCHING TIME vs NEGATIVE SUPPLY VOLTAGE, HI-307

Typical Performance Curves (Continued)

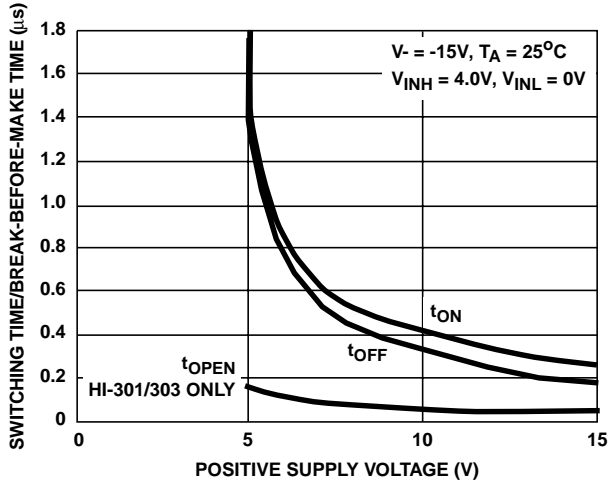

FIGURE 16. SWITCHING TIME AND BREAK-BEFORE-MAKE TIME vs POSITIVE SUPPLY VOLTAGE, HI-301 AND HI-303

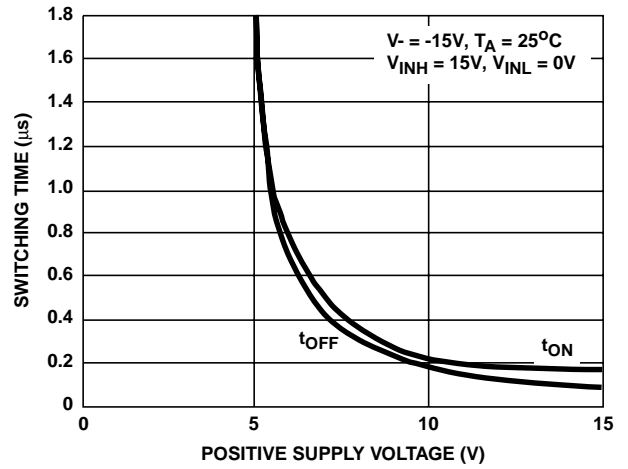

FIGURE 17. SWITCHING TIME vs POSITIVE SUPPLY VOLTAGE, HI-307

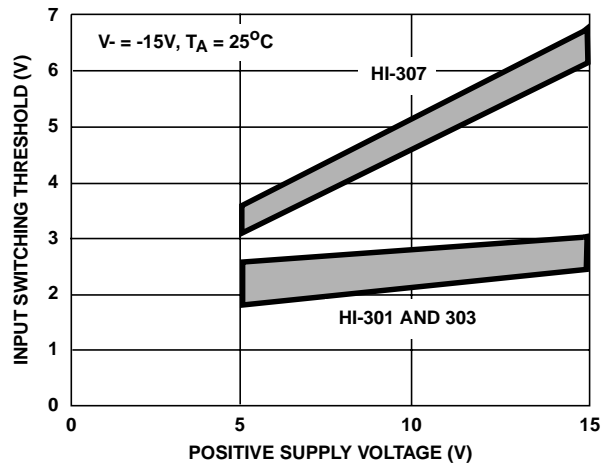
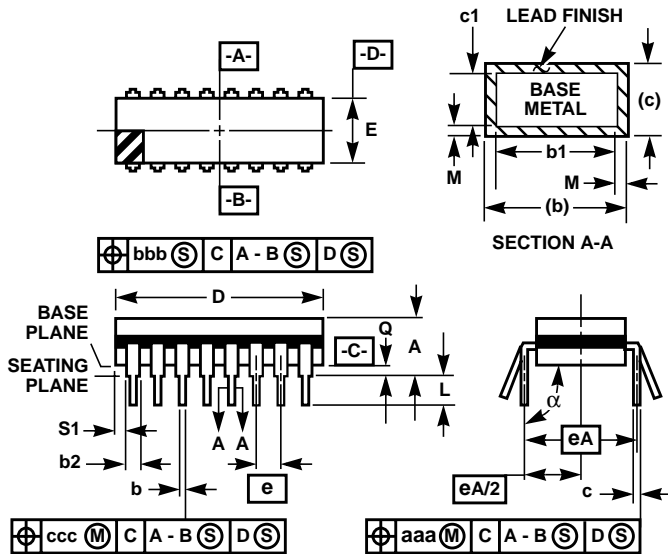

FIGURE 18. INPUT SWITCHING THRESHOLD vs POSITIVE SUPPLY VOLTAGE

Ceramic Dual-In-Line Frit Seal Packages (CERDIP)



NOTES:

1. Index area: A notch or a pin one identification mark shall be located adjacent to pin one and shall be located within the shaded area shown. The manufacturer's identification shall not be used as a pin one identification mark.
2. The maximum limits of lead dimensions b and c or M shall be measured at the centroid of the finished lead surfaces, when solder dip or tin plate lead finish is applied.
3. Dimensions b1 and c1 apply to lead base metal only. Dimension M applies to lead plating and finish thickness.
4. Corner leads (1, N, N/2, and N/2+1) may be configured with a partial lead paddle. For this configuration dimension b3 replaces dimension b2.
5. This dimension allows for off-center lid, meniscus, and glass overrun.
6. Dimension Q shall be measured from the seating plane to the base plane.
7. Measure dimension S1 at all four corners.
8. N is the maximum number of terminal positions.
9. Dimensioning and tolerancing per ANSI Y14.5M - 1982.
10. Controlling dimension: INCH.

F14.3 MIL-STD-1835 GDIP1-T14 (D-1, CONFIGURATION A)
14 LEAD CERAMIC DUAL-IN-LINE FRIT SEAL PACKAGE

SYMBOL	INCHES		MILLIMETERS		NOTES
	MIN	MAX	MIN	MAX	
A	-	0.200	-	5.08	-
b	0.014	0.026	0.36	0.66	2
b1	0.014	0.023	0.36	0.58	3
b2	0.045	0.065	1.14	1.65	-
b3	0.023	0.045	0.58	1.14	4
c	0.008	0.018	0.20	0.46	2
c1	0.008	0.015	0.20	0.38	3
D	-	0.785	-	19.94	5
E	0.220	0.310	5.59	7.87	5
e	0.100 BSC		2.54 BSC		-
eA	0.300 BSC		7.62 BSC		-
eA/2	0.150 BSC		3.81 BSC		-
L	0.125	0.200	3.18	5.08	-
Q	0.015	0.060	0.38	1.52	6
S1	0.005	-	0.13	-	7
alpha	90°	105°	90°	105°	-
aaa	-	0.015	-	0.38	-
bbb	-	0.030	-	0.76	-
ccc	-	0.010	-	0.25	-
M	-	0.0015	-	0.038	2, 3
N	14		14		8

Rev. 0 4/94

Small Outline Plastic Packages (SOIC)

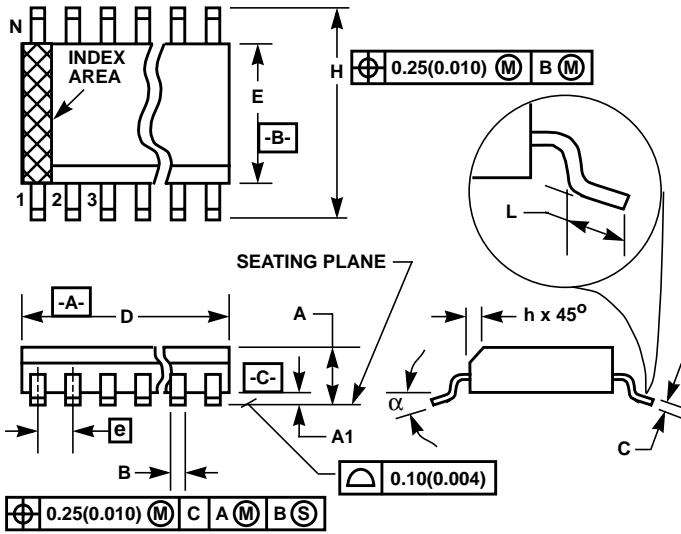

**M14.15 (JEDEC MS-012-AB ISSUE C)
14 LEAD NARROW BODY SMALL OUTLINE PLASTIC PACKAGE**

SYMBOL	INCHES		MILLIMETERS		NOTES
	MIN	MAX	MIN	MAX	
A	0.0532	0.0688	1.35	1.75	-
A1	0.0040	0.0098	0.10	0.25	-
B	0.013	0.020	0.33	0.51	9
C	0.0075	0.0098	0.19	0.25	-
D	0.3367	0.3444	8.55	8.75	3
E	0.1497	0.1574	3.80	4.00	4
e	0.050 BSC		1.27 BSC		-
H	0.2284	0.2440	5.80	6.20	-
h	0.0099	0.0196	0.25	0.50	5
L	0.016	0.050	0.40	1.27	6
N	14		14		7
α	0°	8°	0°	8°	-

NOTES:

1. Symbols are defined in the "MO Series Symbol List" in Section 2.2 of Publication Number 95.
2. Dimensioning and tolerancing per ANSI Y14.5M-1982.
3. Dimension "D" does not include mold flash, protrusions or gate burrs. Mold flash, protrusion and gate burrs shall not exceed 0.15mm (0.006 inch) per side.
4. Dimension "E" does not include interlead flash or protrusions. Interlead flash and protrusions shall not exceed 0.25mm (0.010 inch) per side.
5. The chamfer on the body is optional. If it is not present, a visual index feature must be located within the crosshatched area.
6. "L" is the length of terminal for soldering to a substrate.
7. "N" is the number of terminal positions.
8. Terminal numbers are shown for reference only.
9. The lead width "B", as measured 0.36mm (0.014 inch) or greater above the seating plane, shall not exceed a maximum value of 0.61mm (0.024 inch).
10. Controlling dimension: MILLIMETER. Converted inch dimensions are not necessarily exact.

Rev. 0 12/93

All Intersil semiconductor products are manufactured, assembled and tested under **ISO9000** quality systems certification.

Intersil semiconductor products are sold by description only. Intersil Corporation reserves the right to make changes in circuit design and/or specifications at any time without notice. Accordingly, the reader is cautioned to verify that data sheets are current before placing orders. Information furnished by Intersil is believed to be accurate and reliable. However, no responsibility is assumed by Intersil or its subsidiaries for its use; nor for any infringements of patents or other rights of third parties which may result from its use. No license is granted by implication or otherwise under any patent or patent rights of Intersil or its subsidiaries.

For information regarding Intersil Corporation and its products, see web site www.intersil.com

Sales Office Headquarters

NORTH AMERICA
Intersil Corporation
P. O. Box 883, Mail Stop 53-204
Melbourne, FL 32902
TEL: (321) 724-7000
FAX: (321) 724-7240

EUROPE
Intersil SA
Mercure Center
100, Rue de la Fusee
1130 Brussels, Belgium
TEL: (32) 2.724.2111
FAX: (32) 2.724.22.05

ASIA
Intersil (Taiwan) Ltd.
7F-6, No. 101 Fu Hsing North Road
Taipei, Taiwan
Republic of China
TEL: (886) 2 2716 9310
FAX: (886) 2 2715 3029