

September 1998

OBSOLETE PRODUCT
 See HFA1100, HFA1120, HFA1105
 or contact our Technical Support Center at
 1-888-INTERSIL or www.intersil.com/tsc

Features

- **Wide Gain Bandwidth Product** 1GHz
- **High Slew Rate** 250V/μs
- **High Open Loop Gain** 105V/mV
- **Low Offset Voltage** 0.6mV
- **Low Power Consumption** 143mW
- **Low Input Voltage Noise at 1kHz** 2.7nV/√Hz
- **Monolithic Construction**

Applications

- RF/IF Processors
- Video Amplifiers
- Radar Systems
- Pulse Amplifiers
- High Speed Communications
- Fast Data Acquisition Systems

Description

The HFA-0002 is a very wideband, high slew rate, op amp, featuring precision DC characteristics. Stable in gains of 10 or greater this all bipolar op amp offers a combination of AC and DC performance never seen before in monolithic form.

The high gain bandwidth product (1GHz) and high slew rate (250V/μs) make this op amp ideal for use in video and RF circuits. The low offset voltage (0.6mV), low bias current (0.23μA), and low voltage noise (2.7nV/√Hz) specifications combined with the excellent AC characteristics make this op amp ideal for high speed data acquisition systems with high accuracy.

Part Number Information

PART NUMBER	TEMPERATURE RANGE	PACKAGE
HFA2-0002-5	0°C to +75°C	8 Pin CAN
HFA2-0002-9	-40°C to +85°C	8 Pin CAN
HFA3-0002-5	0°C to +75°C	8 Lead Plastic DIP
HFA3-0002-9	-40°C to +85°C	8 Lead Plastic DIP
HFA7-0002-5	0°C to +75°C	8 Lead Ceramic Sidebrazed DIP
HFA7-0002-9	-40°C to +85°C	8 Lead Ceramic Sidebrazed DIP
HFA9P0002-5	0°C to +75°C	8 Lead SOIC
HFA9P0002-9	-40°C to +85°C	8 Lead SOIC

Pinouts

HFA-0002
(PDIP, CDIP, SOIC)
TOP VIEW

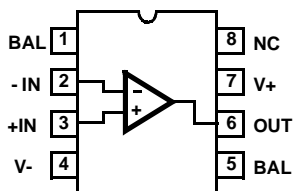

HFA-0002
(TO-99 METAL CAN)
TOP VIEW

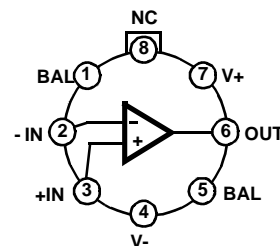

Specifications HFA-0002

Absolute Maximum Ratings (Note 1)

Supply Voltage Between V+ and V-Terminals	12V
Differential Input Voltage	5V
Input Voltage	±5V
Output Current	±20mA
Junction Temperature (Note 10).	+175°C
Junction Temperature (Plastic Package)	+150°C
Lead Temperature (Soldering 10 Sec.)	+300°C

Operating Conditions

Operating Temperature Range :	
HFA-0002-9	-40°C ≤ T _A ≤ +85°C
HFA-0002-5	0°C ≤ T _A ≤ +75°C
Storage Temperature Range	-65°C ≤ T _A ≤ 150°C

CAUTION: Stresses above those listed in "Absolute Maximum Ratings" may cause permanent damage to the device. This is a stress only rating and operation of the device at these or any other conditions above those indicated in the operational sections of this specification is not implied.

Electrical Specifications V+ = +5V, V- = -5V, Unless Otherwise Specified

PARAMETER	TEMP	HFA-0002-5/-9			UNITS
		MIN	TYP	MAX	
INPUT CHARACTERISTICS					
Offset Voltage	+25°C	-	0.6	1	mV
	Full	-	1.2	2	mV
Average Offset Voltage Drift	Full	-	2.0	-	µV/°C
Bias Current	+25°C	-	0.23	1.0	µA
	High	-	0.1	1.0	µA
	Low	-	0.32	2.0	µA
Offset Current	+25°C	-	0.12	1.0	µA
	Full	-	0.16	1.0	µA
Common Mode Range	Full	±2.5	-	-	V
Differential Input Resistance	+25°C	-	1	-	MΩ
Input Capacitance	+25°C	-	2	-	pF
Input Noise Voltage 0.1Hz to 10Hz	+25°C	-	5.1	-	nV _{RMS}
	+25°C	-	2.02	-	µV _{RMS}
Input Noise Voltage f _O = 10Hz	+25°C	-	8.9	-	nV/√Hz
	+25°C	-	3.7	-	nV/√Hz
	+25°C	-	2.7	-	nV/√Hz
Input Noise Current f _O = 10Hz	+25°C	-	25	-	pA/√Hz
	+25°C	-	8.4	-	pA/√Hz
	+25°C	-	4.5	-	pA/√Hz
TRANSFER CHARACTERISTICS					
Large Signal Voltage Gain (Note 2, 4)	Full	80	105	-	V/mV
Common Mode Rejection Ratio (Note 3)	+25°C	100	110	-	dB
	Full	90	108	-	dB
Gain Bandwidth Product f _O = 1MHz	+25°C	-	1	-	GHz
Minimum Stable Gain	Full	10	-	-	V/V
OUTPUT CHARACTERISTICS					
Output Voltage Swing (Note 4)	Full	±3.5	±3.9	-	V
Full Power Bandwidth (Note 5)	+25°C	10.6	13.3	-	MHz
Output Resistance, Open Loop	+25°C	-	5	-	Ω
Output Current	Full	±10	±12	-	mA
TRANSIENT RESPONSE					

Specifications HFA-0002

Electrical Specifications

V+ = +5V, V- = -5V, Unless Otherwise Specified (Continued)

PARAMETER	TEMP	HFA-0002-5/-9			UNITS
		MIN	TYP	MAX	
Rise Time (Note 4, 6)	+25°C	-	3.2	-	ns
Slew Rate (Note 4, 7, 9)	+25°C	200	250	-	V/μs
Settling Time (Note 4, 7)	+25°C	-	50	-	ns
Overshoot (Note 4, 6)	+25°C	-	30	-	%
POWER SUPPLY CHARACTERISTICS					
Supply Current	Full	-	14	20	mA
Power Supply Rejection Ratio (Note 8)	Full	90	99	-	dB

NOTES:

1. Absolute maximum ratings are limiting values, applied individually, beyond which the serviceability of the circuit may be impaired. Functional operation under any of these conditions is not necessarily implied.
2. $V_{OUT} = \pm 3V$.
3. $\Delta V_{CM} = \pm 2V$.
4. $R_L = 5K, C_L = 20pF$.
5. Full Power Bandwidth is guaranteed by equation: $FPBW = \frac{\text{Slew Rate}}{2\pi V_{peak}}, V_{peak} = 3.0V$.
6. $V_{OUT} = \pm 100mV, A_V = +10$.
7. $V_{OUT} = \pm 3V, A_V = +10$.
8. $\Delta V_S = \pm 4V$ to $\pm 6V$.
9. This parameter is not tested. This limit is guaranteed based on characterization and reflects lot to lot variation.
10. See Thermal Constants in "Applications Information" section. Maximum power dissipation, including output load, must be designed to maintain the junction temperature below +175°C for hermetic packages, and below +150°C for plastic packages.

Simplified Schematic Diagram

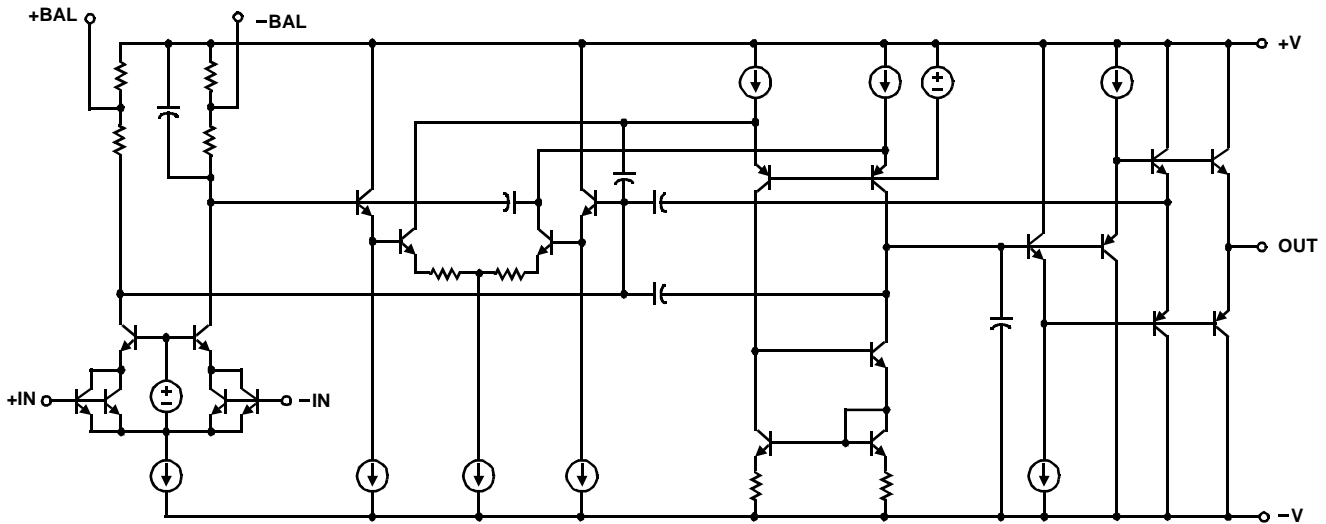

Die Characteristics

Thermal Constants (°C/W)	θ_{JA}	θ_{JC}
CAN	117	36
PDIP	96	34
CDIP	75	13
SOIC	158	43

Test Circuits

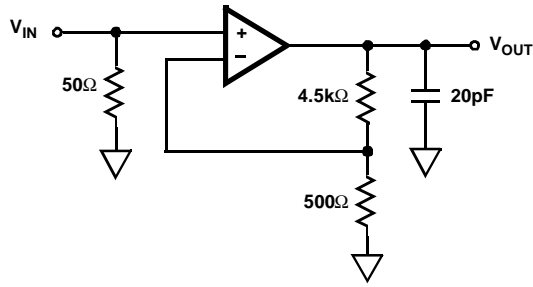
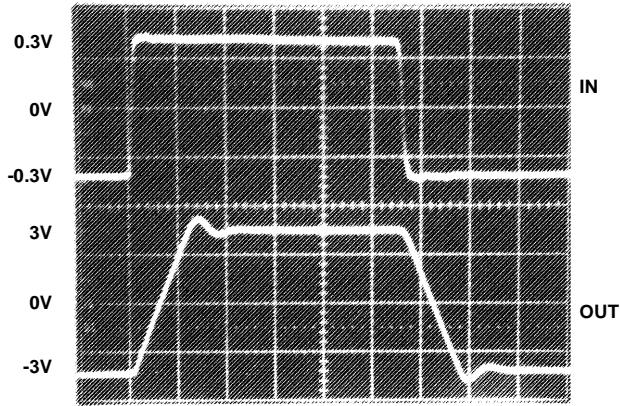
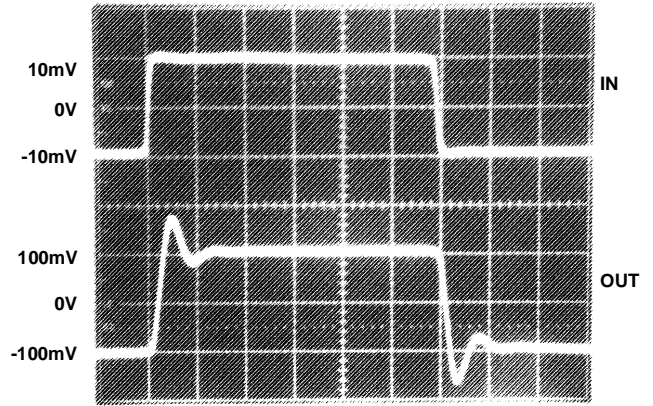

FIGURE 1. LARGE AND SMALL SIGNAL RESPONSE TEST CIRCUIT



LARGE SIGNAL RESPONSE
 Input: 0.2V/Div. Output: 2V/Div.
 Horizontal Scale: 20ns/Div.



SMALL SIGNAL RESPONSE
 Input: 10mV/Div. Output: 100mV/Div.

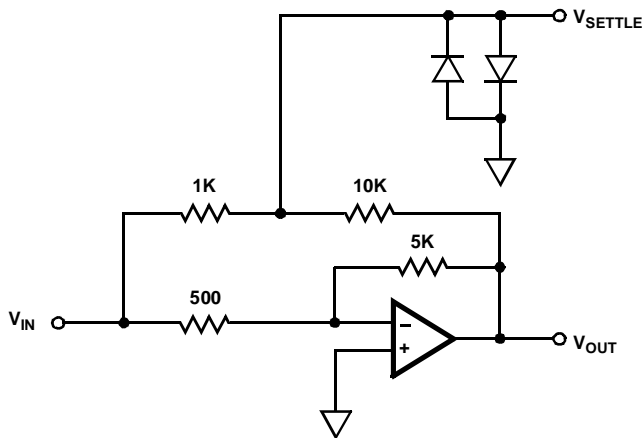

- $A_V = -10$
- Feedback and summing resistors must be matched (0.1%)
- HP5082-2810 clipping diodes recommended
- Tektronix P6201 FET probe used at settling point

FIGURE 3. SETTLING TIME SCHEMATIC

Typical Performance Curves $V_S = \pm 5V, T_A = +25^\circ C$, Unless Otherwise Specified

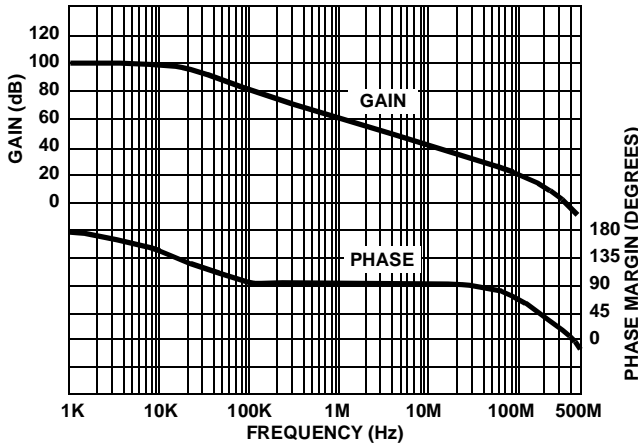

FIGURE 4. OPEN LOOP GAIN AND PHASE vs FREQUENCY

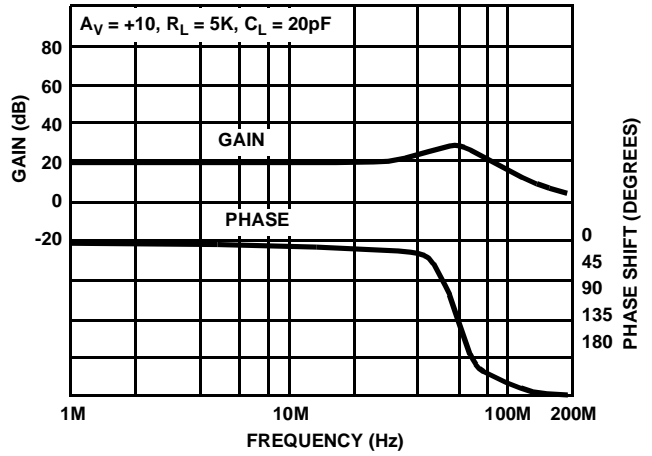

FIGURE 5. CLOSED LOOP GAIN vs FREQUENCY

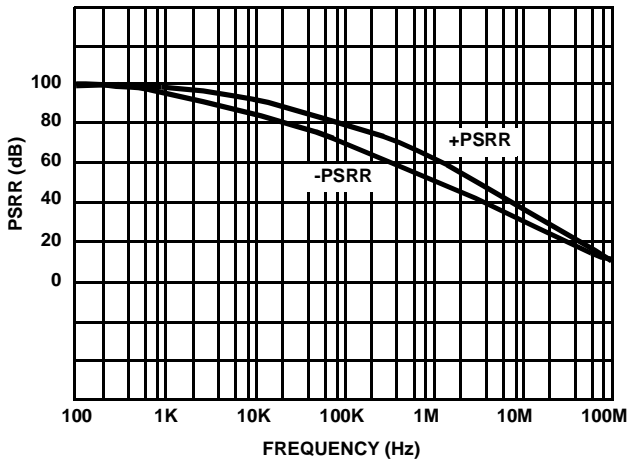

FIGURE 6. PSRR vs FREQUENCY

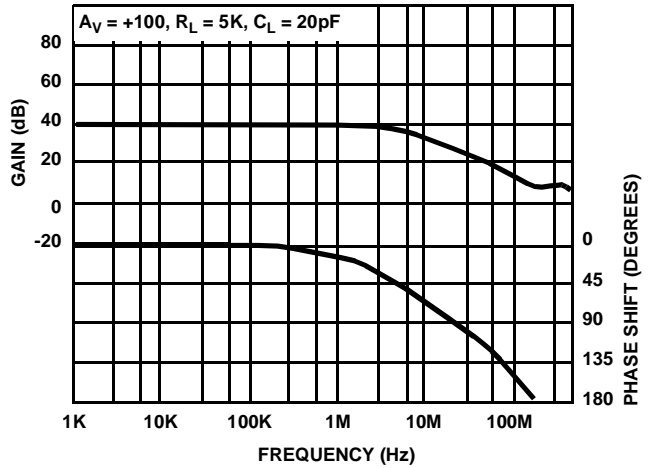

FIGURE 7. CLOSED LOOP GAIN vs FREQUENCY

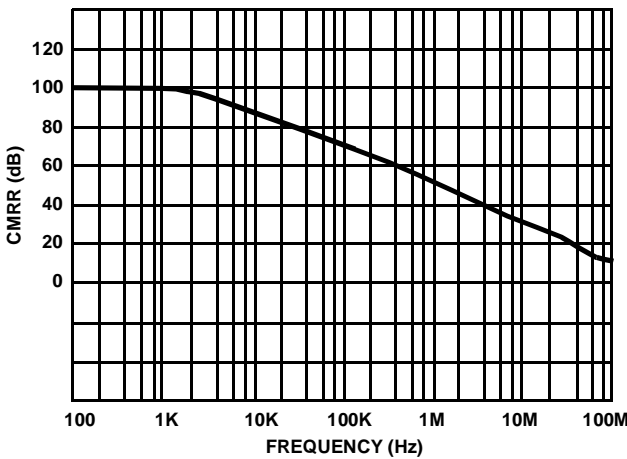

FIGURE 8. CMRR vs FREQUENCY

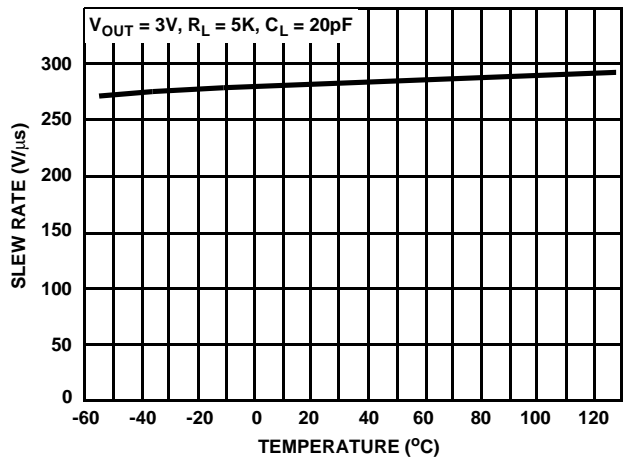

FIGURE 9. SLEW RATE vs TEMPERATURE

Typical Performance Curves $V_S = \pm 5V, T_A = +25^\circ C$, Unless Otherwise Specified (Continued)

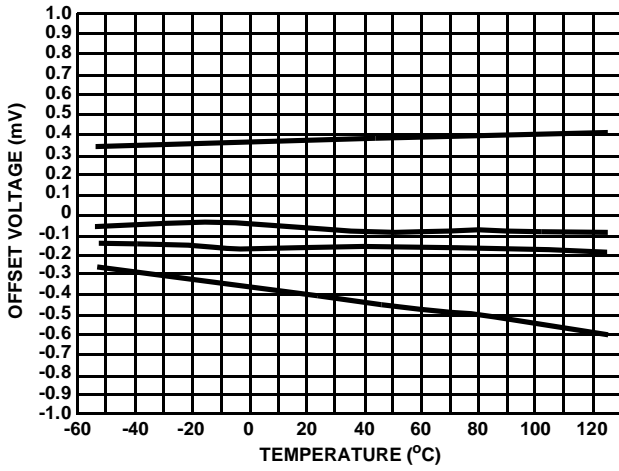

FIGURE 10. OFFSET VOLTAGE vs TEMPERATURE
4 Representative Units

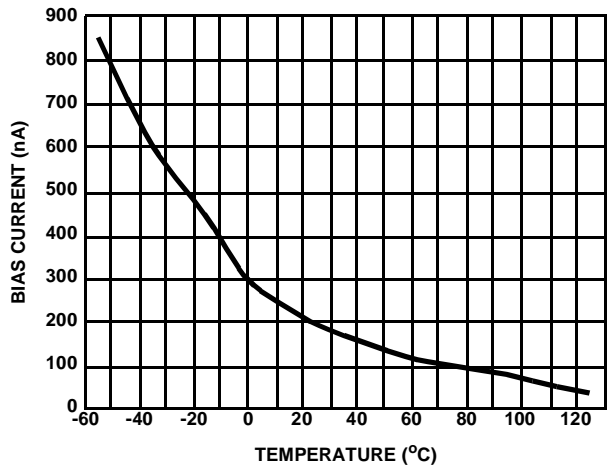

FIGURE 11. BIAS CURRENT vs TEMPERATURE

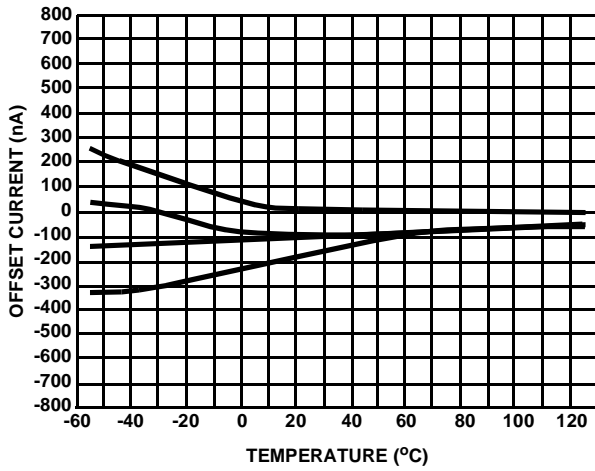

FIGURE 12. OFFSET CURRENT vs TEMPERATURE
4 Representative Units

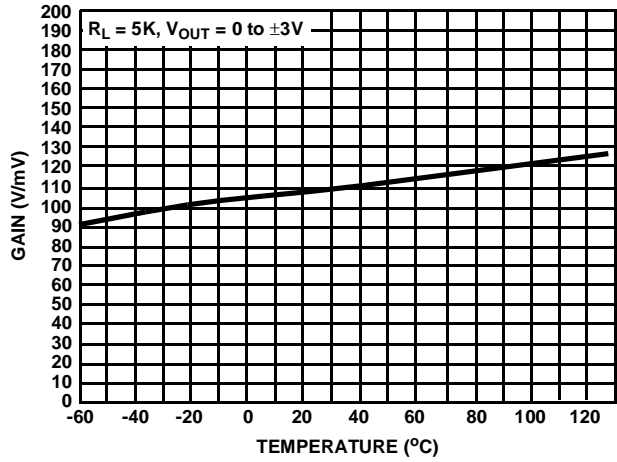

FIGURE 13. OPEN LOOP GAIN vs TEMPERATURE
 $R_L = 5K, V_{OUT} = 0 \text{ to } \pm 3V$

Typical Performance Curves $V_S = \pm 5V, T_A = +25^\circ C$, Unless Otherwise Specified (Continued)

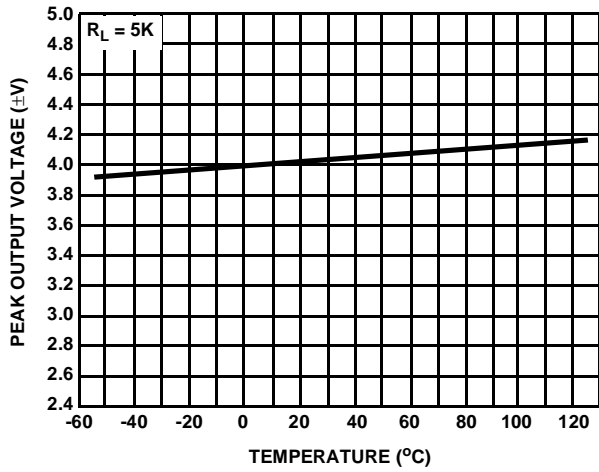

FIGURE 14. OUTPUT VOLTAGE SWING vs TEMPERATURE

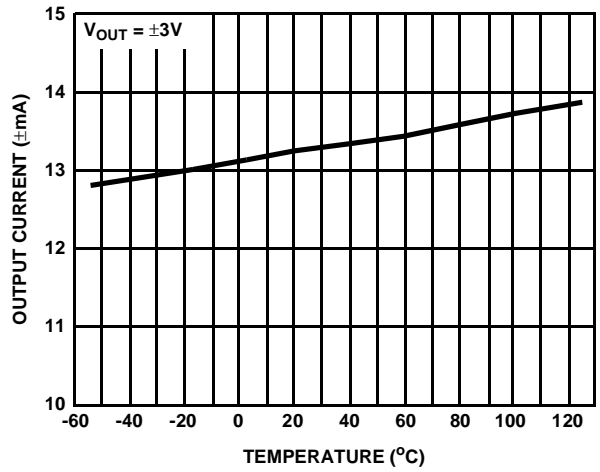

FIGURE 15. OUTPUT CURRENT vs TEMPERATURE

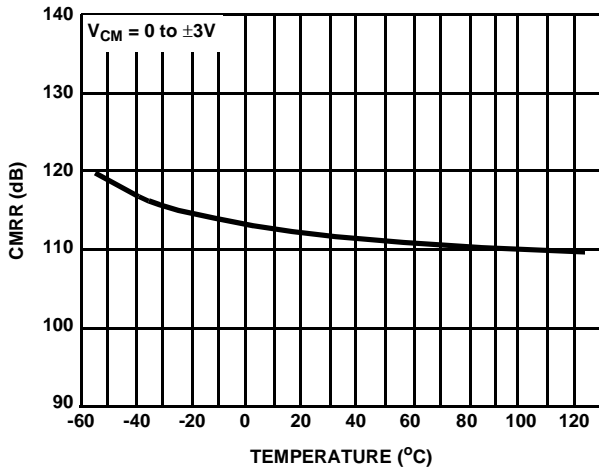

FIGURE 16. CMRR vs TEMPERATURE

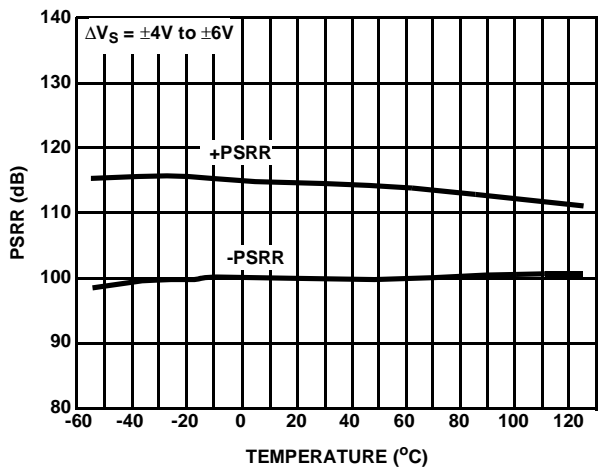

FIGURE 17. PSRR vs TEMPERATURE

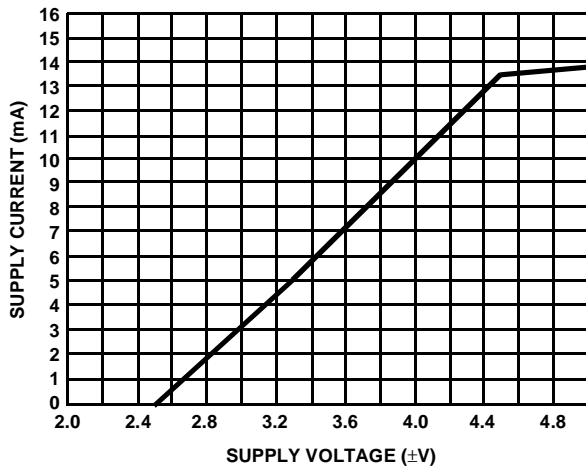

FIGURE 18. SUPPLY CURRENT vs SUPPLY VOLTAGE

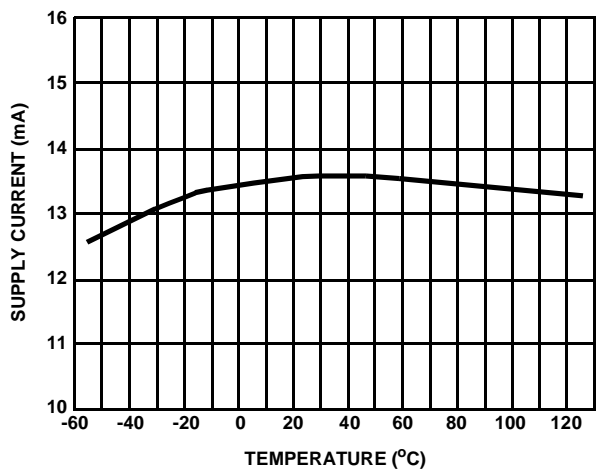

FIGURE 19. SUPPLY CURRENT vs TEMPERATURE

Typical Performance Curves $V_S = \pm 5V, T_A = +25^\circ C$, Unless Otherwise Specified (Continued)

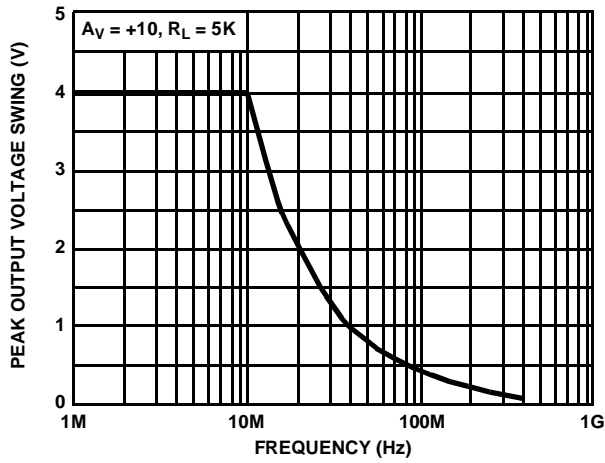

FIGURE 20. OUTPUT VOLTAGE SWING vs FREQUENCY

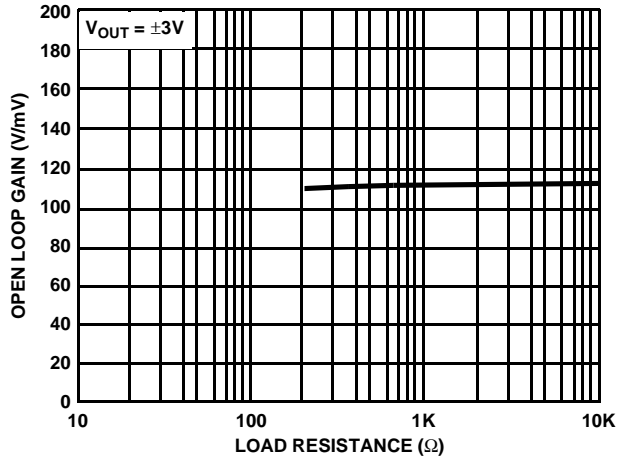

FIGURE 21. OPEN LOOP GAIN vs LOAD RESISTANCE

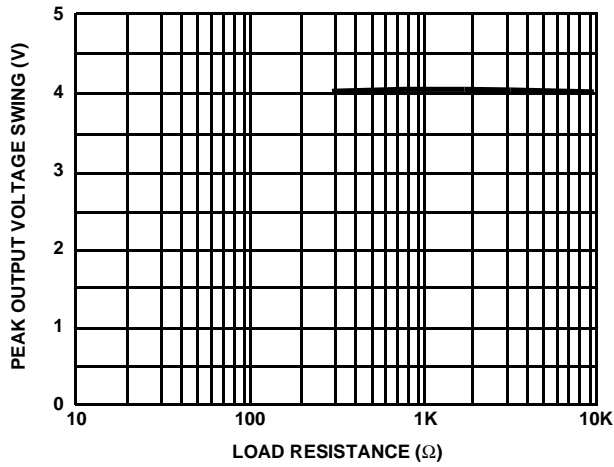

FIGURE 22. OUTPUT VOLTAGE SWING vs LOAD RESISTANCE

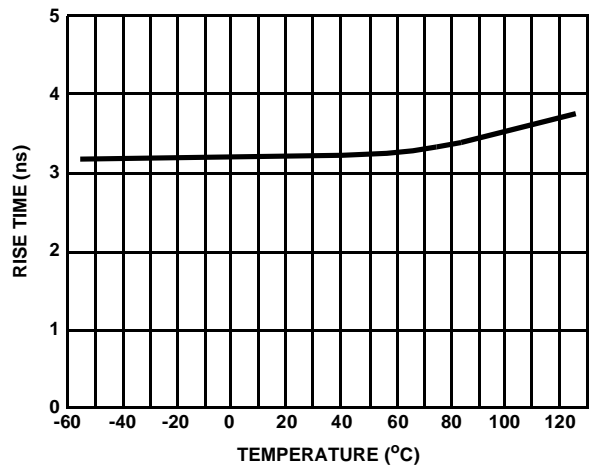

FIGURE 23. RISE TIME vs TEMPERATURE

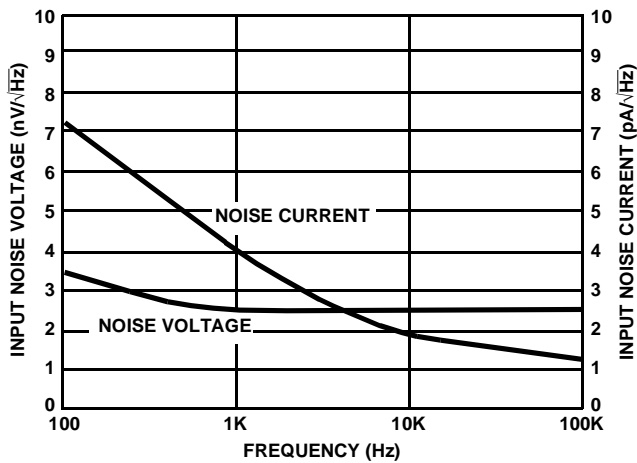

FIGURE 24. INPUT NOISE vs FREQUENCY

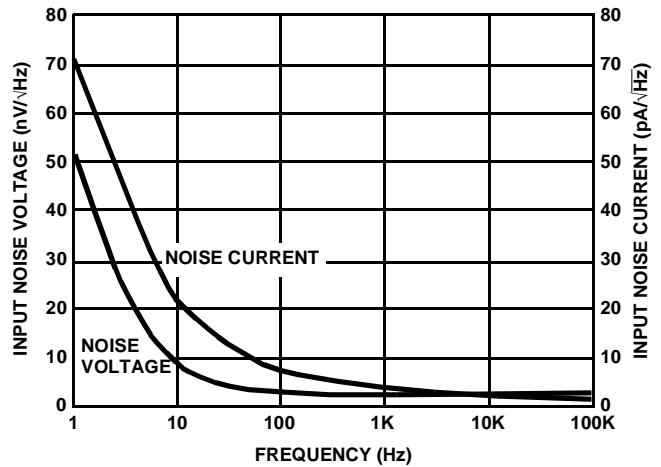

FIGURE 25. INPUT NOISE vs FREQUENCY

Typical Performance Curves $V_S = \pm 5V$, $T_A = +25^\circ C$, Unless Otherwise Specified (Continued)

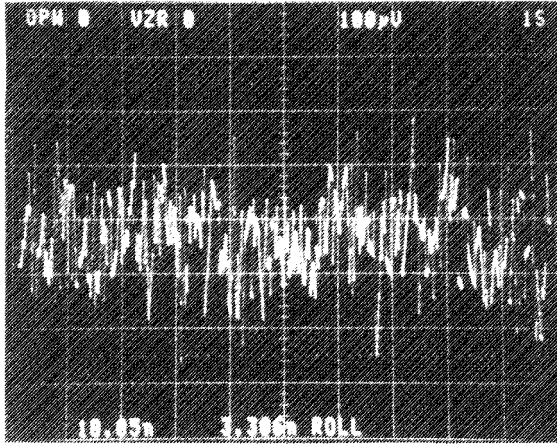

FIGURE 26. INPUT NOISE VOLTAGE
0.1Hz to 10Hz
 $A_V = 25,000$, Noise Voltage = $3.31nV_{RMS}$ (RTI)

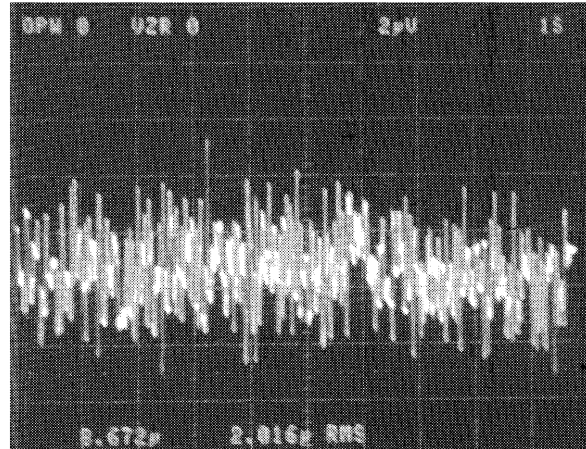

FIGURE 27. INPUT NOISE VOLTAGE
10Hz to 1MHz
 $A_V = 500$, Noise Voltage = $2.02\mu V_{RMS}$ (RTI)

Applications Information

Offset Voltage Adjustment

The HFA-0002, due to its low offset voltage, will typically not require any external offset adjustment. If certain applications do require lower offset, the following diagram shows one possible configuration.

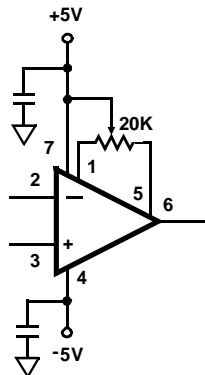

FIGURE 29.

The power supply lines must be well decoupled to filter any power supply noise. A 20K trim pot will allow an offset adjustment of about 3mV, referred to input.

PC Board Layout Guidelines

When designing with the HFA-0002, good high frequency (RF) techniques should be used when doing pc board layouts. A massive ground plane should be used to maintain a low impedance ground. PC board traces should be kept as short as possible and kept wide to minimize trace inductance and impedance. Stray capacitance at the op amps output and at the high impedance inputs should be kept to a minimum, to prevent any unwanted phase shift and bandwidth limiting.

When breadboarding remember to keep feedback resistor values low ($\leq 5k\Omega$) for optimum performance. The use of metal film resistors for values over 200Ω and carbon film resistors under 200Ω typically gives the best performance. Remember to keep all lead lengths as short as possible to minimize lead inductance.

Sockets will add parasitic capacitance and inductance and therefore can limit AC performance as well as reduce stability. If sockets must be used, a low profile socket with minimum pin to pin capacitance will minimize any performance degradation.

Power supply decoupling is essential for high frequency op amps. A $0.01\mu\text{F}$ high quality ceramic capacitor at each supply pin in parallel with a $1\mu\text{F}$ tantalum capacitor will provide excellent decoupling. Chip capacitors produce the best results due to the ease of placement next to the op amp and they have negligible lead inductance. If leaded capacitors are used, again the lead lengths should be kept to a minimum.

Saturation Recovery

When an op amp is over driven output devices can saturate

and sometime take a long time to recover. By clamping the input to safe levels, output saturation can be avoided. If output saturation cannot be avoided, the recovery time for an input sine wave at 25% overdrive is 100ns.