

High Speed, Single Channel, Power MOSFET Driver

The EL7104 is a matched driver IC that improves the operation of the industry-standard TC-4420/29 clock drivers. The Elantec version is a very high speed driver capable of delivering peak currents of 1A into highly capacitive loads. The high speed performance is achieved by means of a proprietary “Turbo-Driver” circuit that speeds up input stages by tapping the wider voltage swing at the output. Improved speed and drive capability are enhanced by matched rise and fall delay times. These matched delays maintain the integrity of input-to-output pulse-widths to reduce timing errors and clock skew problems. This improved performance is accompanied by a 10-fold reduction in supply currents over bipolar drivers, yet without the delay time problems commonly associated with CMOS drivers.

The EL7104 is available in 8-pin SO and 8-pin PDIP packages and is specified for operation over the full -40°C to +85°C temperature range.

Ordering Information

PART NUMBER	PACKAGE	TAPE & REEL	PKG. DWG. #
EL7104CN	8-Pin PDIP	-	MDP0031
EL7104CS	8-Pin SO	-	MDP0027
EL7104CS-T7	8-Pin SO	7"	MDP0027
EL7104CS-T13	8-Pin SO	13"	MDP0027
EL7104CSZ (See Note)	8-Pin SO (Pb-free)	-	MDP0027
EL7104CSZ-T7 (See Note)	8-Pin SO (Pb-free)	7"	MDP0027
EL7104CSZ-T13 (See Note)	8-Pin SO (Pb-free)	13"	MDP0027

NOTE: Intersil Pb-free products employ special Pb-free material sets; molding compounds/die attach materials and 100% matte tin plate termination finish, which are RoHS compliant and compatible with both SnPb and Pb-free soldering operations. Intersil Pb-free products are MSL classified at Pb-free peak reflow temperatures that meet or exceed the Pb-free requirements of IPC/JEDEC J STD-020.

Features

- Industry-standard driver replacement
- Improved response times
- Matched rise and fall times
- Reduced clock skew
- Low output impedance
- Low input capacitance
- High noise immunity
- Improved clocking rate
- Low supply current
- Wide operating range
- Separate drain connections
- Pb-Free available (RoHS compliant)

Applications

- Clock/line drivers
- CCD drivers
- Ultrasound transducer drivers
- Power MOSFET drivers
- Switch mode power supplies
- Resonant charging
- Cascoded drivers

Pinout

EL7104
(8-PIN SO, PDIP)
TOP VIEW

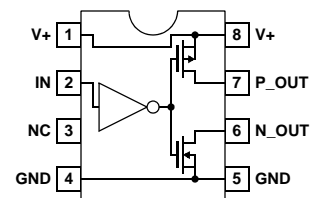

EL7104

Absolute Maximum Ratings (T_A = 25°C)

Supply (V+ to GND) 16.5V
 Input Pins -0.3V to +0.3V above V+
 Peak Output Current4A
 Ambient Operating Temperature -40°C to +85°C

Storage Temperature Range -65°C to +150°C
 Operating Junction Temperature +125°C
 Power Dissipation
 SO570mW
 PDIP1050mW

CAUTION: Stresses above those listed in "Absolute Maximum Ratings" may cause permanent damage to the device. This is a stress only rating and operation of the device at these or any other conditions above those indicated in the operational sections of this specification is not implied.

IMPORTANT NOTE: All parameters having Min/Max specifications are guaranteed. Typ values are for information purposes only. Unless otherwise noted, all tests are at the specified temperature and are pulsed tests, therefore: T_J = T_C = T_A

DC Electrical Specifications V+ = 15V, T_A = 25°C unless otherwise specified.

PARAMETER	DESCRIPTION	CONDITIONS	MIN	TYP	MAX	UNIT
INPUT						
V _{IH}	Logic "1" Input Voltage		2.4			V
I _{IH}	Logic "1" Input Current	@V+		0.1	10	μA
V _{IL}	Logic "0" Input Voltage				0.8	V
I _{IL}	Logic "0" Input Current	@0V		0.1	10	μA
V _{HVS}	Input Hysteresis			0.3		V
OUTPUT						
R _{OH}	Pull-Up Resistance	I _{OUT} = -100mA		1.5	4	Ω
R _{OL}	Pull-Down Resistance	I _{OUT} = +100mA		2	4	Ω
I _{OUT}	Output Leakage Current	V+/GND		0.2	10	μA
I _{PK}	Peak Output Current	Source/Sink		4.0		A
I _{DC}	Continuous Output Current	Source/Sink	200			mA
POWER SUPPLY						
I _S	Power Supply Current	Input = V+		4.5	7.5	mA
V _S	Operating Voltage		4.5		16	V

AC Electrical Specifications V = 15V, T_A = 25°C unless otherwise specified.

PARAMETER	DESCRIPTION	CONDITIONS	MIN	TYP	MAX	UNIT
SWITCHING CHARACTERISTICS (V_{DD} = V_H = 12V; V_L = -3V)						
t _R	Rise Time	C _L = 1000pF		7.5		ns
		C _L = 2000pF		10	20	ns
t _F	Fall Time	C _L = 1000pF		10		ns
		C _L = 2000pF		15	20	ns
t _{D-ON}	Turn-On Delay Time	See Timing Table		18	25	ns
t _{D-OFF}	Turn-Off Delay Time	See Timing Table		18	25	ns

Timing Table

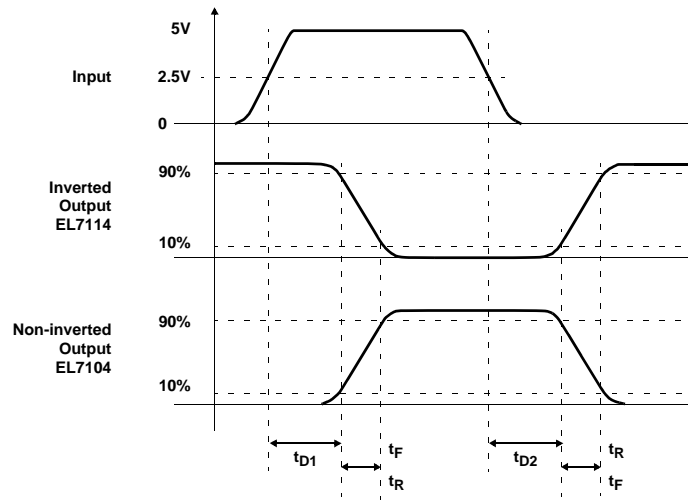

Standard Test Configuration

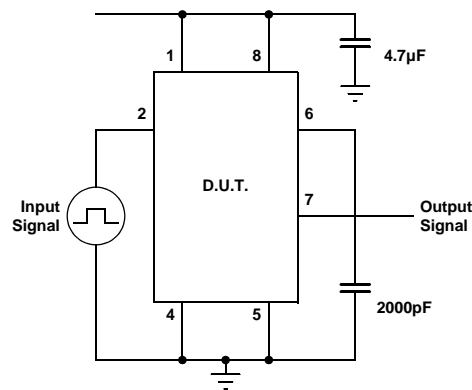

Simplified Schematic

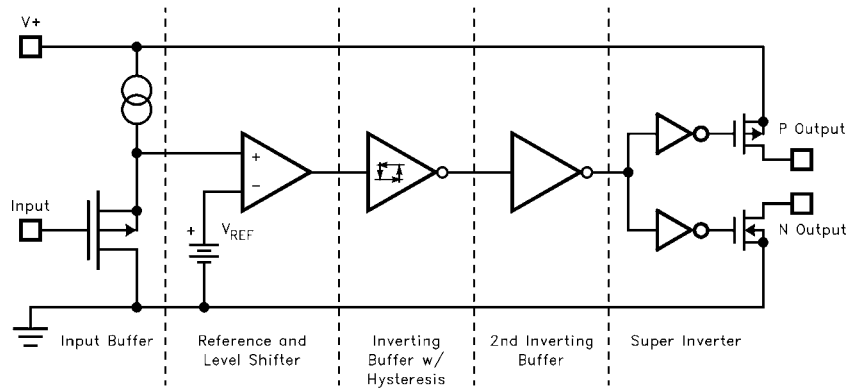

Typical Performance Curves

Max Power/Derating Curves

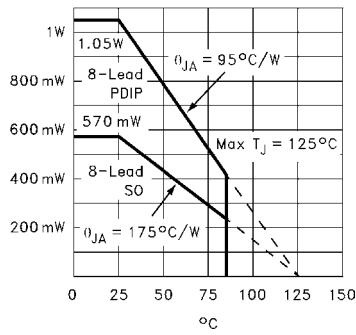

Switch Threshold vs Supply Voltage

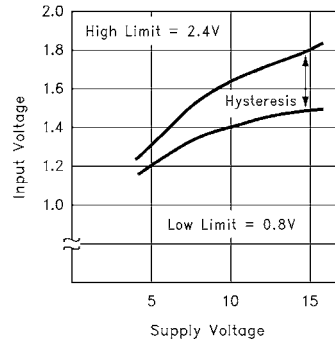

Input Current vs Voltage

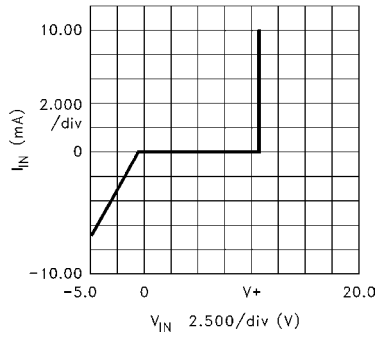

Peak Drive vs Supply Voltage

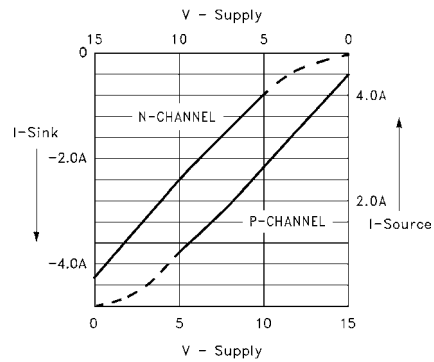

Quiescent Supply Current

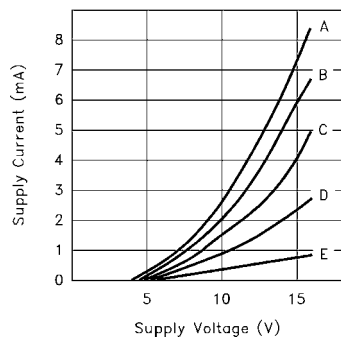

CASE:

Device	Input Level	Curve
EL7104	GND	A
EL7104	V+	C
EL7114	GND	C
EL7114	V+	E

"ON" Resistance vs Supply Voltage

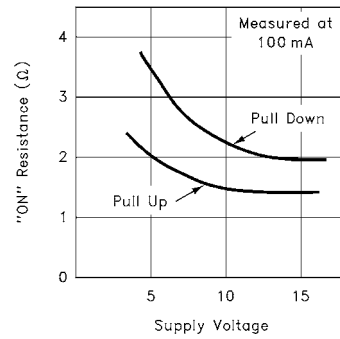

Typical Performance Curves (Continued)

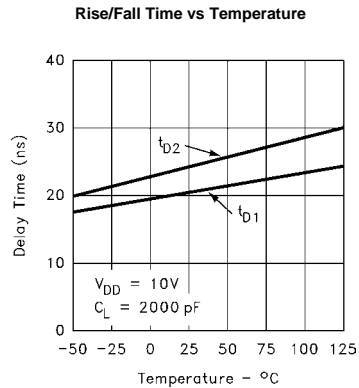
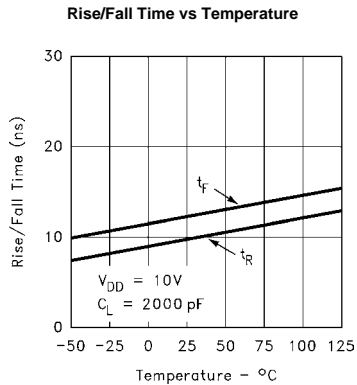
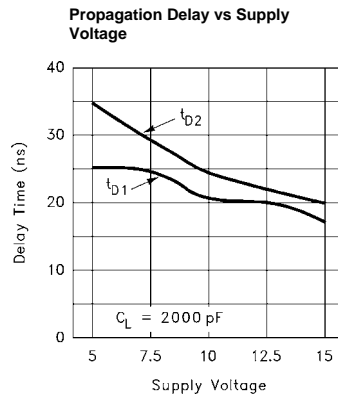
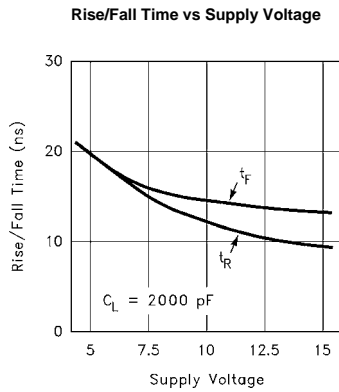
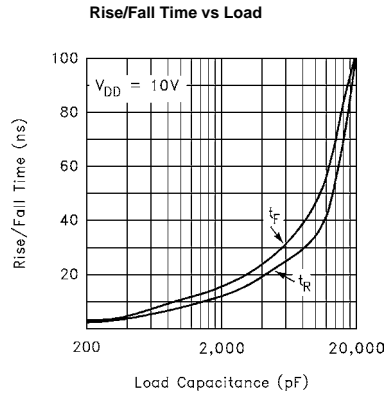
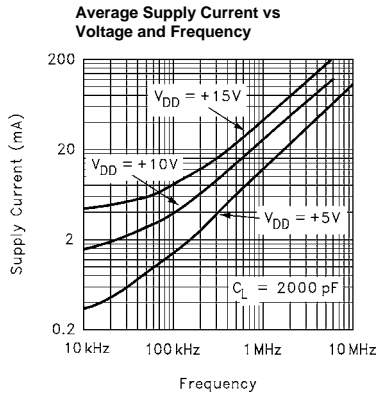

All Intersil U.S. products are manufactured, assembled and tested utilizing ISO9000 quality systems. Intersil Corporation's quality certifications can be viewed at www.intersil.com/design/quality

Intersil products are sold by description only. Intersil Corporation reserves the right to make changes in circuit design, software and/or specifications at any time without notice. Accordingly, the reader is cautioned to verify that data sheets are current before placing orders. Information furnished by Intersil is believed to be accurate and reliable. However, no responsibility is assumed by Intersil or its subsidiaries for its use; nor for any infringements of patents or other rights of third parties which may result from its use. No license is granted by implication or otherwise under any patent or patent rights of Intersil or its subsidiaries.

For information regarding Intersil Corporation and its products, see www.intersil.com