

PNP Silicon High Voltage Transistor

- High breakdown voltage
- Low collector-emitter saturation voltage
- Complementary type: SMBTA 42 (NPN)

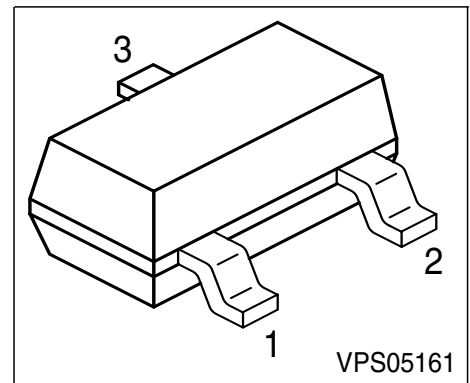

Type	Marking	Pin Configuration			Package
SMBTA 92	s2D	1=B	2=E	3=C	SOT-23

Maximum Ratings

Parameter	Symbol	Value	Unit
Collector-emitter voltage	V_{CEO}	300	V
Collector-base voltage	V_{CBO}	300	
Emitter-base voltage	V_{EBO}	5	
DC collector current	I_C	500	mA
Base current	I_B	100	
Total power dissipation, $T_S = 74\text{ °C}$	P_{tot}	360	mW
Junction temperature	T_j	150	°C
Storage temperature	T_{stg}	-65 ... 150	

Thermal Resistance

Junction ambient ¹⁾	R_{thJA}	≤280	K/W
Junction - soldering point	R_{thJS}	≤210	

1) Package mounted on pcb 40mm x 40mm x 1.5mm / 6cm² Cu

Electrical Characteristics at $T_A = 25^\circ\text{C}$, unless otherwise specified.

Parameter	Symbol	Values			Unit
		min.	typ.	max.	
DC Characteristics					
Collector-emitter breakdown voltage $I_C = 1\text{ mA}, I_B = 0$	$V_{(BR)CEO}$	300	-	-	V
Collector-base breakdown voltage $I_C = 100\ \mu\text{A}, I_B = 0$	$V_{(BR)CBO}$	300	-	-	
Emitter-base breakdown voltage $I_E = 100\ \mu\text{A}, I_C = 0$	$V_{(BR)EBO}$	5	-	-	
Collector cutoff current $V_{CB} = 200\text{ V}, I_E = 0$	I_{CBO}	-	-	250	nA
Collector cutoff current $V_{CB} = 200\text{ V}, I_E = 0, T_A = 150\ ^\circ\text{C}$	I_{CBO}	-	-	20	μA
Emitter cutoff current $V_{EB} = 5\text{ V}, I_C = 0$	I_{EBO}	-	-	100	nA
DC current gain 1) $I_C = 1\text{ mA}, V_{CE} = 10\text{ V}$ $I_C = 10\text{ mA}, V_{CE} = 10\text{ V}$ $I_C = 30\text{ mA}, V_{CE} = 10\text{ V}$	h_{FE}	25 40 25	- - -	- - -	-
Collector-emitter saturation voltage1) $I_C = 20\text{ mA}, I_B = 2\text{ mA}$	V_{CEsat}	-	-	0.5	V
Base-emitter saturation voltage 1) $I_C = 20\text{ mA}, I_B = 2\text{ mA}$	V_{BEsat}	-	-	0.9	
AC Characteristics					
Transition frequency $I_C = 20\text{ mA}, V_{CE} = 10\text{ V}, f = 100\text{ MHz}$	f_T	50	-	-	MHz
Collector-base capacitance $V_{CB} = 20\text{ V}, f = 1\text{ MHz}$	C_{cb}	-	-	6	pF

 1) Pulse test: $t < 300\ \mu\text{s}; D < 2\%$

Total power dissipation $P_{tot} = f(T_A^*; T_S)$

* Package mounted on epoxy

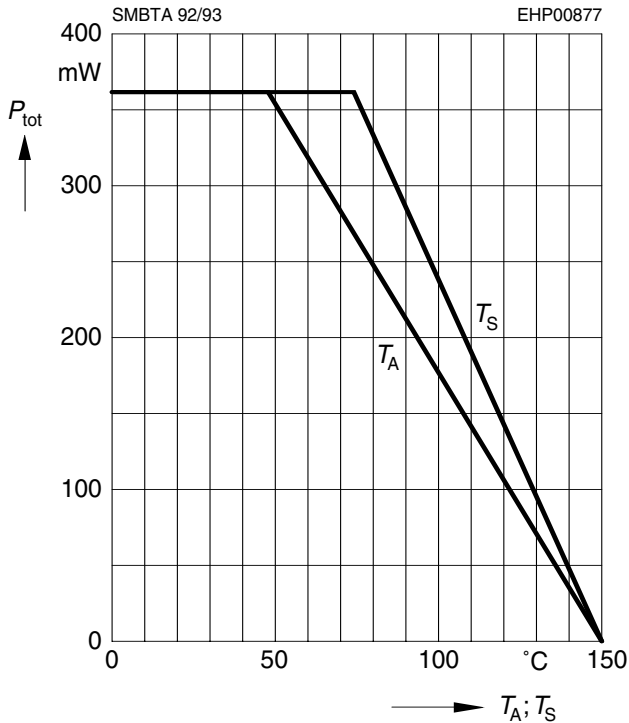

Transition frequency $f_T = f(I_C)$

$V_{CE} = 20V, f = 100MHz$

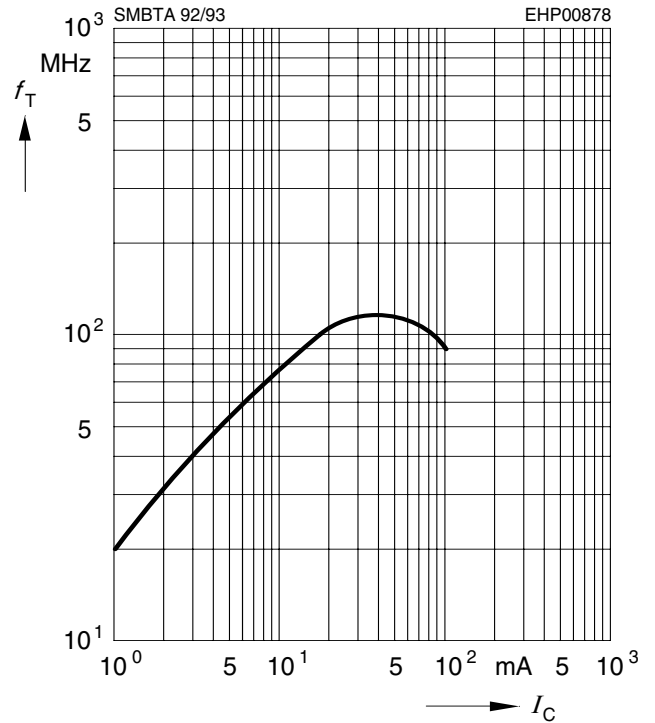

Permissible pulse load

$P_{totmax} / P_{totDC} = f(t_p)$

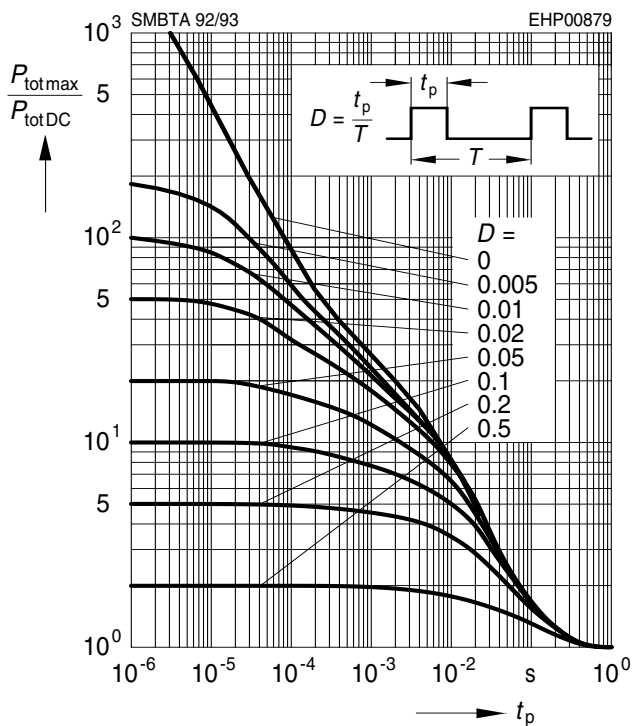

Operating range $I_C = f(V_{CE0})$

$T_A = 25°C, D = 0$

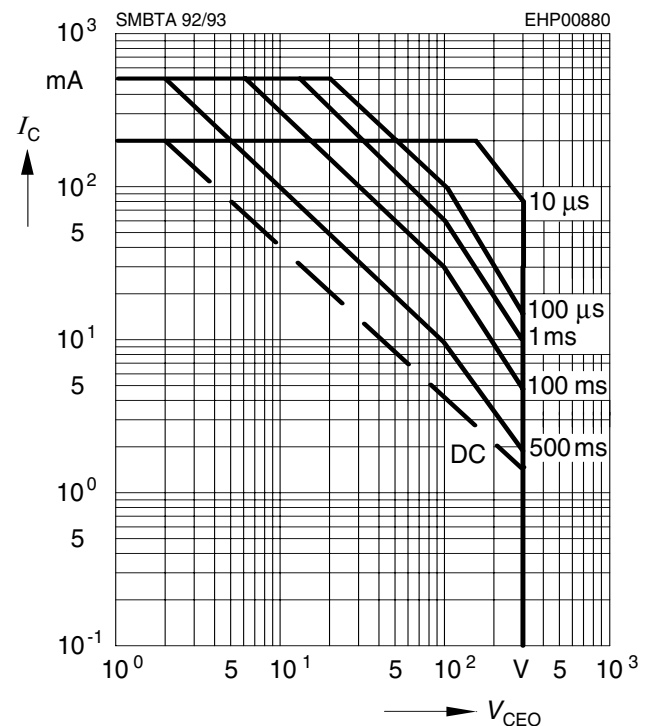

Collector cutoff current $I_{CBO} = f(T_A)$

$V_{CB} = 200V$

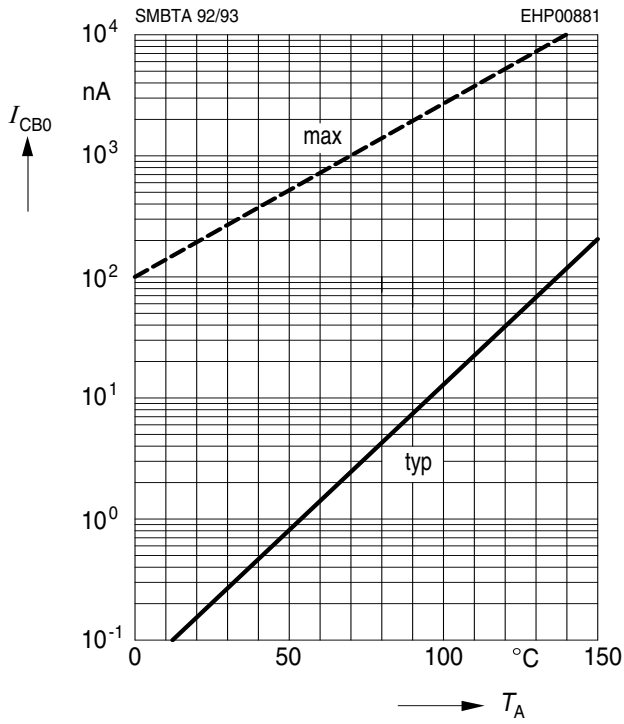

Collector current $I_C = f(V_{BE})$

$V_{CE} = 10V$

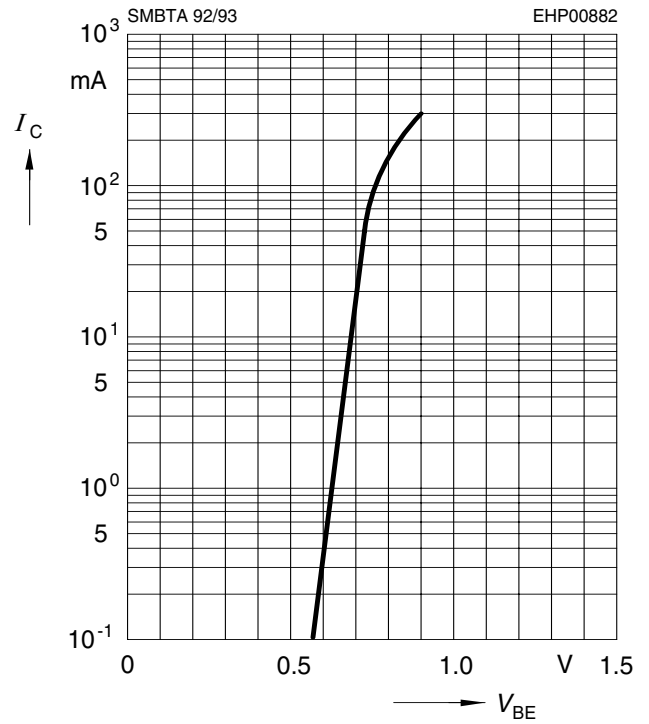

DC current gain $h_{FE} = f(I_C)$

$V_{CE} = 10V$

