



Electrical Characteristics

Parameter and Conditions at $T_j = 25\text{ °C}$, $V_{bb} = 24\text{V}$ unless otherwise specified	Symbol	Values			Unit
		min	typ	max	

Load Switching Capabilities and Characteristics

On-state resistance (pin 4 to 1) $I_L = 1.0\text{ A}$, $V_{in} = \text{high}$	$T_j = 25\text{ °C}$ $T_j = 125\text{ °C}$	R_{ON}	-- --	0.16 --	0.2 0.38	Ω
Nominal load current (pin 4 to 1) ⁵⁾ ISO Standard: $V_{ON} = V_{bb} - V_{OUT} = 0.5\text{ V}$ $T_S = 85\text{ °C}$		$I_{L(ISO)}$	1.4	--	--	A
Turn-on time to 90% V_{OUT}		t_{on}	--	60	100	μs
Turn-off time to 10% V_{OUT} $R_L = 24\ \Omega$		t_{off}	--	90	150	μs
Slew rate on 10 to 30% V_{OUT} , $R_L = 24\ \Omega$		dV/dt_{on}	--	2	4	$\text{V}/\mu\text{s}$
Slew rate off 70 to 40% V_{OUT} , $R_L = 24\ \Omega$		$-dV/dt_{off}$	--	2	4	$\text{V}/\mu\text{s}$

Input

Allowable input voltage range, (pin 3 to 2)		V_{IN}	-3.0	--	V_{bb}	V
Input turn-on threshold voltage $V_{bb} = 18\text{...}30\text{V}$	 $T_j = -25\text{...}+125\text{ °C}$	$V_{IN(T+)}$	--	--	3.0	V
Input turn-off threshold voltage $V_{bb} = 18\text{...}30\text{V}$	 $T_j = -25\text{...}+125\text{ °C}$	$V_{IN(T-)}$	1.82	--	--	V
Input threshold hysteresis		$\Delta V_{IN(T)}$	--	0.1	--	V
Off state input current (pin 3) $V_{IN(off)} = 1.82\text{ V}$ $T_j = -25\text{...}+125\text{ °C}$		$I_{IN(off)}$	20	--	--	μA
On state input current (pin 3) $V_{IN(on)} = 3.0\text{ V to } V_{bb}$ $T_j = -25\text{...}+125\text{ °C}$		$I_{IN(on)}$	--	--	110	μA
Input resistance $T_j = -25\text{...}+125\text{ °C}$		R_{IN}	1.5	2.8	3.5	$\text{k}\Omega$

⁵⁾ $I_{L(ISO)}$ is limited by the current limitation, see $I_{L(SC)}$

Parameter and Conditions at $T_j = 25^\circ\text{C}$, $V_{bb} = 24\text{V}$ unless otherwise specified	Symbol	Values			Unit
		min	typ	max	

Operating Parameters

Operating voltage	$T_j = -25\dots+125^\circ\text{C}$	$V_{bb(\text{on})}$	12		40	V
Undervoltage shutdown	$T_j = -25\dots+125^\circ\text{C}$	$V_{bb(\text{under})}$	7	--	10.5	V
Undervoltage restart	$T_j = -25\dots+125^\circ\text{C}$:	$V_{bb(\text{u rst})}$	--	--	11	V
Undervoltage hysteresis		$\Delta V_{bb(\text{under})}$	--	0.4	--	V
Standby current (pin 4), $V_{in} = \text{low}$	$T_j = -25\dots+100^\circ\text{C}$ $T_j = 125^\circ\text{C}^{6)}$	$I_{bb(\text{off})}$	--	10	25 50	μA
Operating current (pin 2), $V_{in} = \text{high}$	$T_j = -25\dots+125^\circ\text{C}$	I_{GND}	--	1	1.6	mA
leakage current (pin 1) $V_{in} = \text{low}$	$T_j = -25\dots+125^\circ\text{C}$	$I_{L(\text{off})}$	--	--	2	μA

Protection Functions

Current limit (pin 4 to 1)	$T_j = 25^\circ\text{C}$	$I_{L(\text{SC})}$	1.4	2.5	4.0	A
	$T_j = -25\dots+125^\circ\text{C}$		1.4	--	4.8	
Oversvoltage protection $I_{bb}=4\text{mA}$	$T_j = -25\dots+125^\circ\text{C}$	$V_{bb(\text{AZ})}$	48	--	--	V
Output clamp (ind. load switch off) $V_{\text{OUT}} = V_{bb} - V_{\text{ON}(\text{CL})}$, $I_{bb} = 4\text{mA}$		$V_{\text{ON}(\text{CL})}$	--	72	--	V
Thermal overload trip temperature		T_{jt}	135	150	--	$^\circ\text{C}$
Thermal hysteresis		ΔT_{jt}	--	10	--	K
Inductive load switch-off energy dissipation ⁷⁾ $T_{j\text{Start}} = 85^\circ\text{C}$, single pulse, $I_L = 1.0\text{A}$, $V_{bb} = 12\text{V}$		E_{AS}	--	--	0.3	J

Reverse Battery

Reverse battery voltage ⁸⁾		$-V_{bb}$			30	V
Continuous reverse drain current	$T_A = 25^\circ\text{C}$	$-I_S$	--	--	1	A
Drain-Source diode voltage $I_F = 1\text{A}$, $V_{in} = \text{low}$	$V_{\text{OUT}} > V_{bb}$	$-V_{\text{ON}}$	--	--	1.2	V

6) increase of standby current at $T_j = 125^\circ\text{C}$ caused by temperature sense current

7) while demagnetizing load inductance, dissipated energy is $E_{\text{AS}} = \int (V_{\text{ON}(\text{CL})} * i_L(t) dt$,

approx. $E_{\text{AS}} = \frac{1}{2} * L * I_L^2 * \left(\frac{V_{\text{ON}(\text{CL})}}{V_{\text{ON}(\text{CL})} - V_{bb}} \right)$

8) Requires $150\ \Omega$ resistor in GND connection. Reverse load current (through intrinsic drain-source diode) is normally limited by the connected load.

Max allowable power dissipation

$P_{tot} = f(T_A, T_{SP})$

P_{tot} [W]

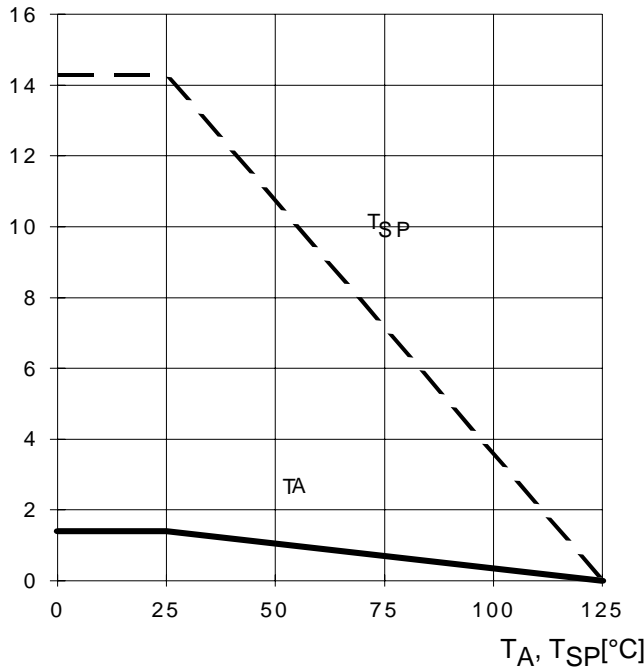

Current limit characteristic

$I_L(SC) = f(V_{on})$, (V_{on} see testcircuit)

$I_L(SC)$ [A]

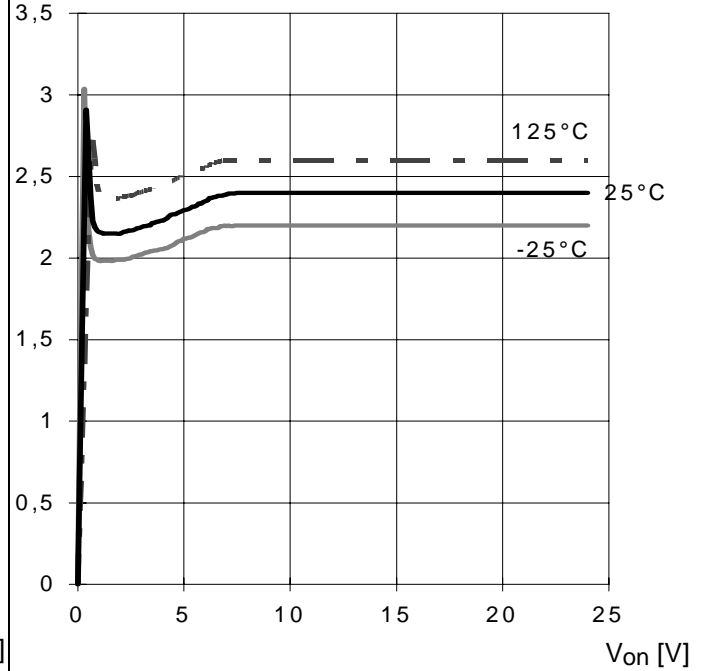

On state resistance (Vbb-pin to OUT pin)

$R_{ON} = f(T_j); V_{bb} = 24 V; I_L = 1.0 A$

R_{ON} [Ω]

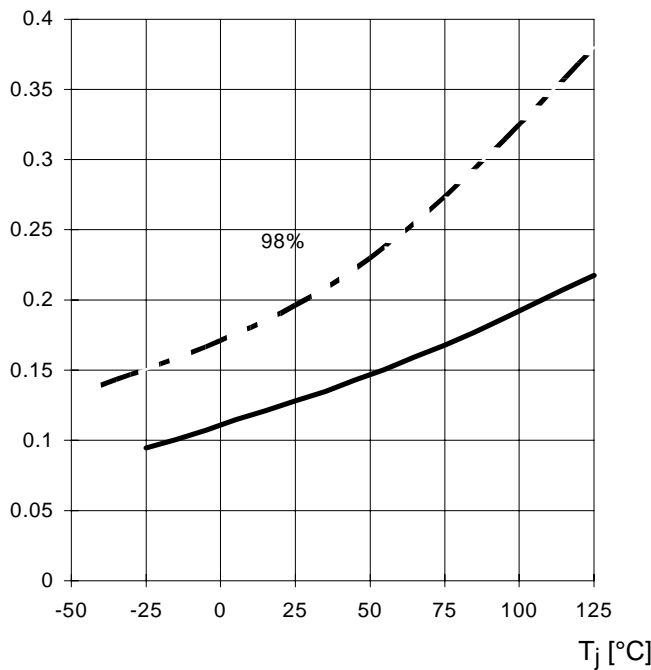

Typ. input current

$I_{IN} = f(V_{IN}); V_{bb} = 24 V$

I_{IN} [μA]

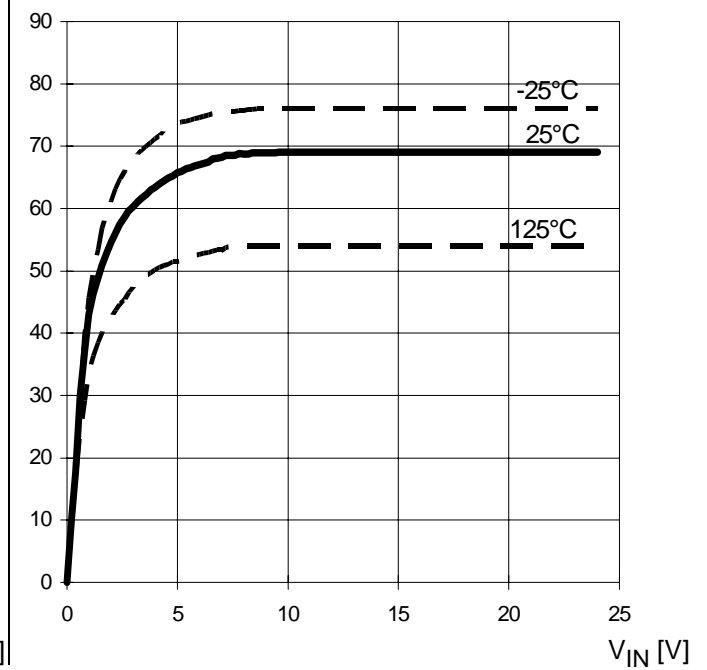

Typ. overload current

$I_{L(lim)} = f(t)$, $V_{bb}=24V$, no heatsink, Param.: T_{jstart}
 $I_{L(lim)}$ [A]

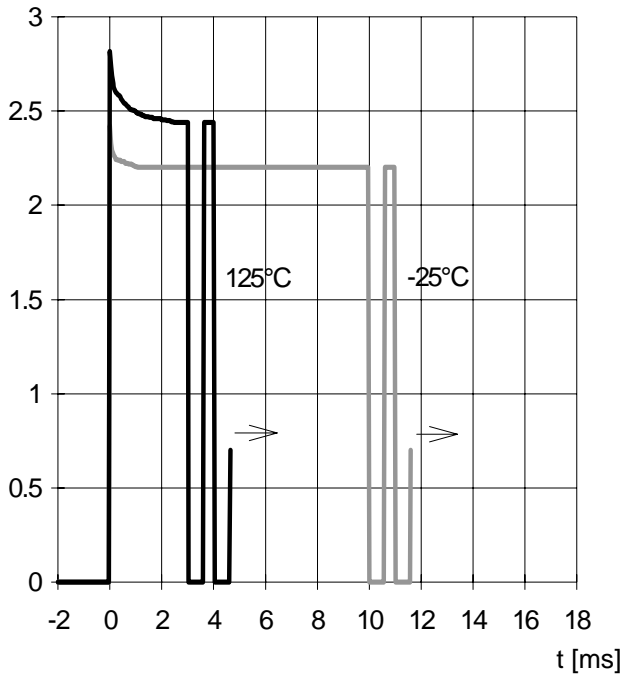

Typ. operating current

$I_{GND} = f(T_j)$, $V_{bb}=30V$, $V_{IN}=high$
 I_{GND} [mA]

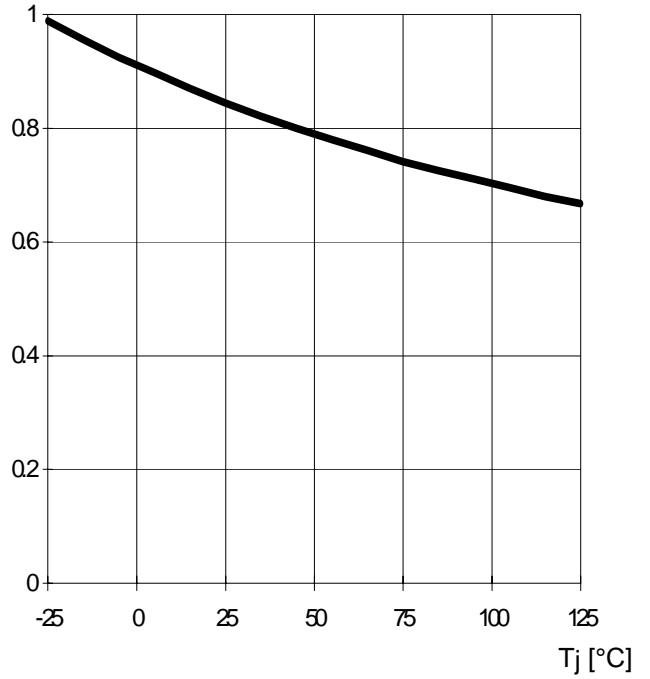

Short circuit current

$I_{L(SC)} = f(T_j)$; $V_{bb} = 30 V$;
 $I_{L(SC)}$ [A]

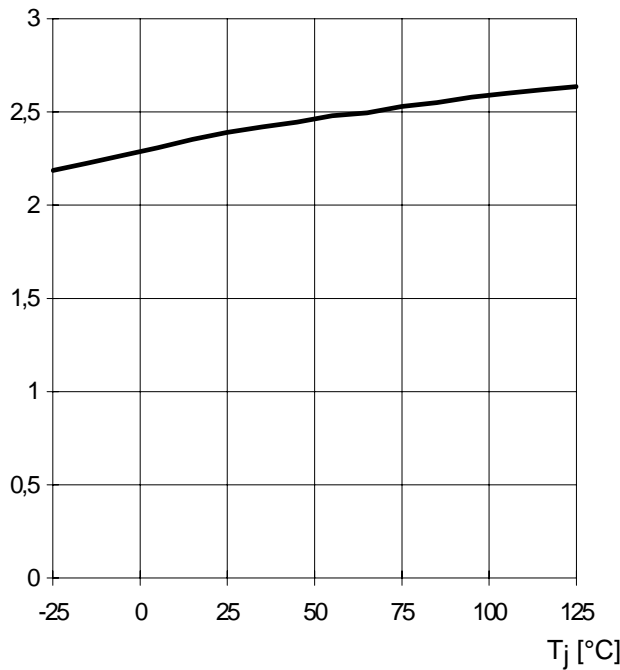

Typ. standby current

$I_{bb(off)} = f(T_j)$; $V_{bb} = 30 V$, $V_{IN} = low$
 $I_{bb(off)}$ [μA]

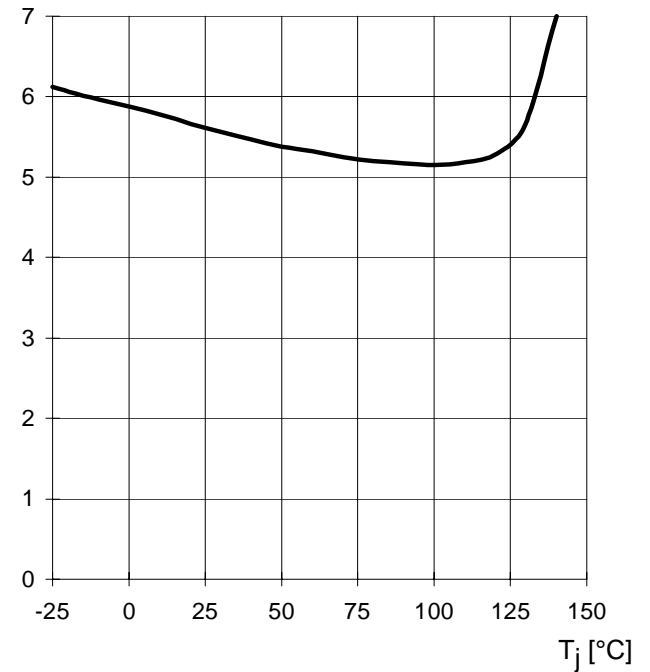

Typ. input turn on voltage threshold

$V_{IN(T+)} = f(T_j)$

$V_{IN(T+)} [V]$

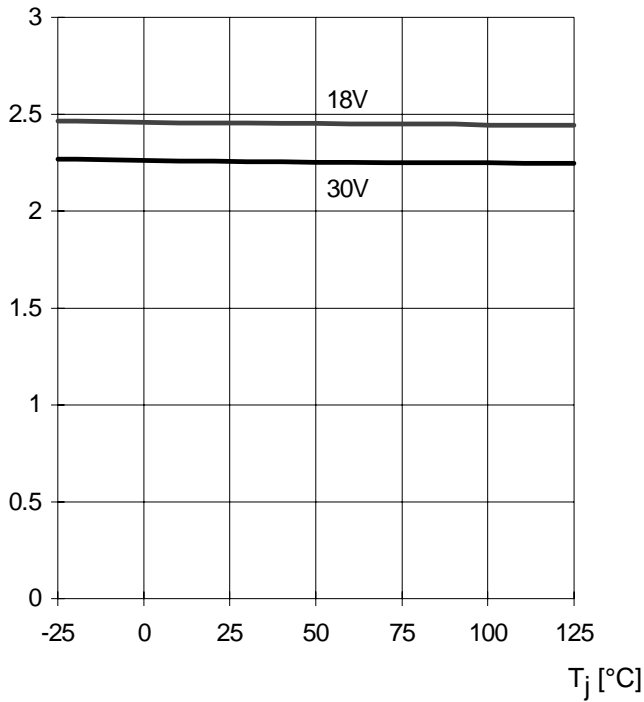

Typ. on-state resistance (V_{bb}-Pin to OUT-Pin)

$R_{ON} = f(V_{bb}); I_L = 1.0A, T_j = 25^{\circ}C;$

$R_{ON} [m\Omega]$

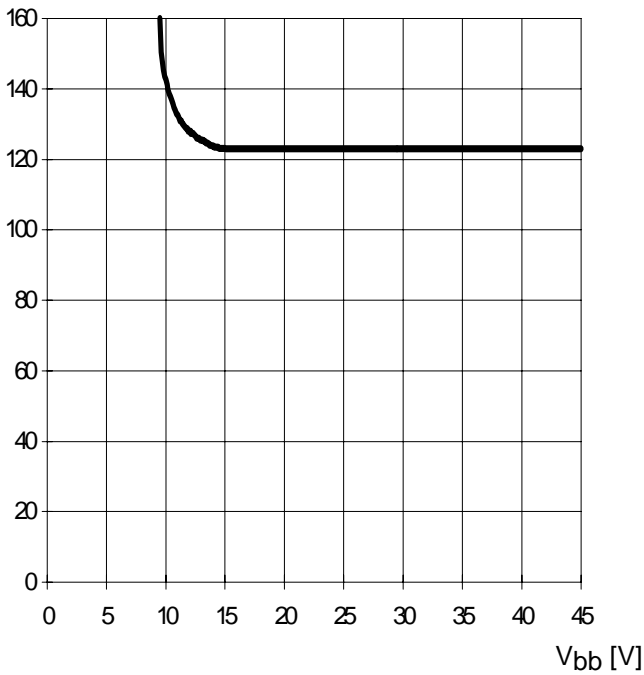

Test circuit

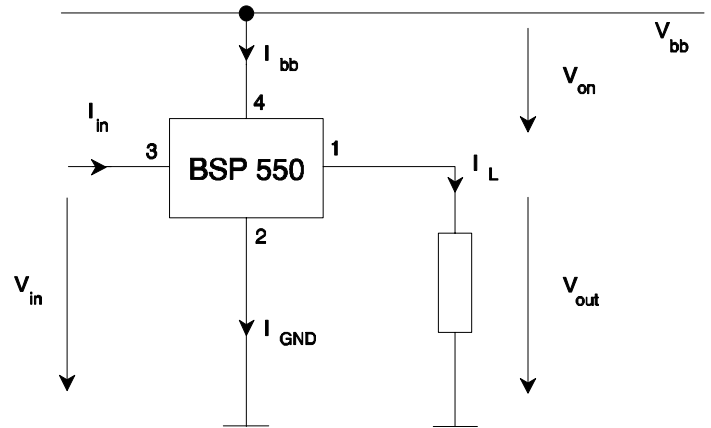

Package:

all dimensions in mm.

SOT 223/4:

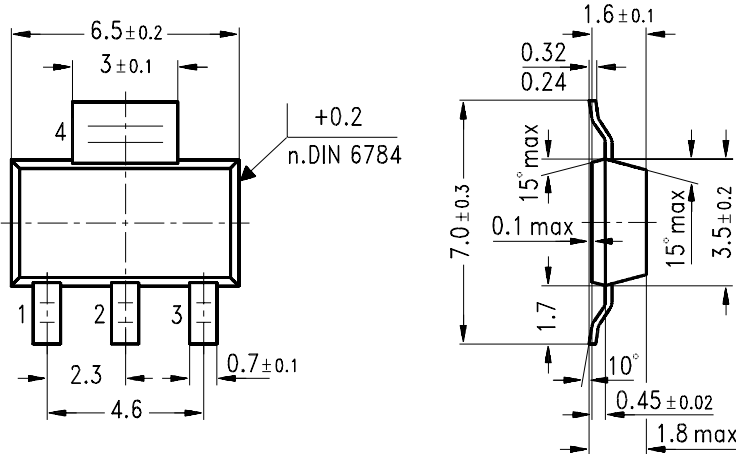

GPS05560

Edition 7.97

Published by Siemens AG,
Bereich Halbleiter Vertrieb,
Werbung, Balanstraße 73,
81541 München

© Siemens AG 1997
All Rights Reserved.

Attention please!

As far as patents or other rights of third parties are concerned, liability is only assumed for components, not for applications, processes and circuits implemented within components or assemblies.

The information describes a type of component and shall not be considered as warranted characteristics.

Terms of delivery and rights to change design reserved.

For questions on technology, delivery and prices please contact the Semiconductor Group Offices in Germany or the Siemens Companies and Representatives worldwide (see address list).

Due to technical requirements components may contain dangerous substances. For information on the types in question please contact your nearest Siemens Office, Semiconductor Group.

Siemens AG is an approved CECC manufacturer.

Packing

Please use the recycling operators known to you. We can also help you - get in touch with your nearest sales office. By agreement we will take packing material back, if it is sorted. You must bear the costs of transport.

For packing material that is returned to us unsorted or which we are not obliged to accept, we shall have to invoice you for any costs incurred.

Components used in life-support devices or systems must be expressly authorized for such purpose!

Critical components¹ of the Semiconductor Group of Siemens AG, may only be used in life-support devices or systems² with the express written approval of the Semiconductor Group of Siemens AG.

1) A critical component is a component used in a life-support device or system whose failure can reasonably be expected to cause the failure of that life-support device or system, or to affect its safety or effectiveness of that device or system.

2) Life support devices or systems are intended (a) to be implanted in the human body, or (b) to support and/or maintain and sustain and/or protect human life. If they fail, it is reasonable to assume that the health of the user or other persons may be endangered.