

**PNP Silicon AF Transistors**

- For general AF applications
- High collector current
- High current gain
- Low collector-emitter saturation voltage
- Complementary type: BCX68 (NPN)

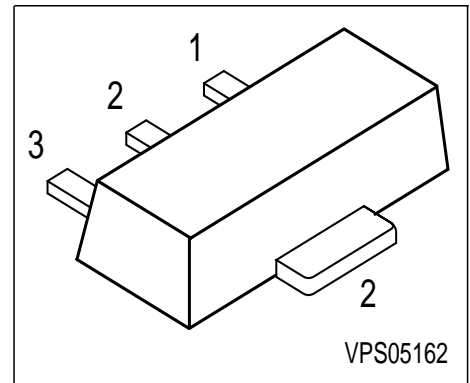

Type	Marking	Pin Configuration			Package
BCX69	CE	1 = B	2 = C	3 = E	SOT89
BCX69-10	CF	1 = B	2 = C	3 = E	SOT89
BCX69-16	CG	1 = B	2 = C	3 = E	SOT89
BCX69-25	CH	1 = B	2 = C	3 = E	SOT89

**Maximum Ratings**

Parameter	Symbol	Values	Unit
Collector-emitter voltage	$V_{CEO}$	20	V
Collector-base voltage	$V_{CBO}$	25	
Emitter-base voltage	$V_{EBO}$	5	
DC collector current	$I_C$	1	A
Peak collector current	$I_{CM}$	2	
Base current	$I_B$	100	mA
Peak base current	$I_{BM}$	200	
Total power dissipation, $T_S = 130\text{ °C}$	$P_{tot}$	1	W
Junction temperature	$T_j$	150	°C
Storage temperature	$T_{stg}$	-65 ... 150	

**Thermal Resistance**

Junction - soldering point <sup>1)</sup>	$R_{thJS}$	≤20	K/W
--	------------	-----	-----

<sup>1)</sup>For calculation of  $R_{thJA}$  please refer to Application Note Thermal Resistance

**Electrical Characteristics** at  $T_A = 25^\circ\text{C}$ , unless otherwise specified.

Parameter	Symbol	Values			Unit
		min.	typ.	max.	
<b>Characteristics</b>					
Collector-emitter breakdown voltage $I_C = 30\text{ mA}, I_B = 0$	$V_{(BR)CEO}$	20	-	-	V
Collector-base breakdown voltage $I_C = 10\text{ }\mu\text{A}, I_B = 0$	$V_{(BR)CBO}$	25	-	-	
Emitter-base breakdown voltage $I_E = 1\text{ }\mu\text{A}, I_C = 0$	$V_{(BR)EBO}$	5	-	-	
Collector cutoff current $V_{CB} = 25\text{ V}, I_E = 0$	$I_{CBO}$	-	-	100	nA
Collector cutoff current $V_{CB} = 25\text{ V}, I_E = 0, T_A = 150\text{ }^\circ\text{C}$	$I_{CBO}$	-	-	100	$\mu\text{A}$
DC current gain 1) $I_C = 5\text{ mA}, V_{CE} = 10\text{ V}$	$h_{FE}$	50	-	-	-
DC current gain 1) $I_C = 500\text{ mA}, V_{CE} = 1\text{ V}$	$h_{FE}$				
	BCX69	85	-	375	
	BCX69-10	85	100	160	
	BCX69-16	100	160	250	
	BCX69-25	160	250	375	
DC current gain 1) $I_C = 1\text{ A}, V_{CE} = 1\text{ V}$	$h_{FE}$	60	-	-	
Collector-emitter saturation voltage1) $I_C = 1\text{ A}, I_B = 100\text{ mA}$	$V_{CEsat}$	-	-	0.5	V
Base-emitter voltage 1) $I_C = 5\text{ mA}, V_{CE} = 10\text{ V}$ $I_C = 1\text{ A}, V_{CE} = 1\text{ V}$	$V_{BE(ON)}$	-	0.6	-	
		-	-	1	
<b>AC Characteristics</b>					
Transition frequency $I_C = 100\text{ mA}, V_{CE} = 5\text{ V}, f = 20\text{ MHz}$	$f_T$	-	100	-	MHz

 1) Pulse test:  $t \leq 300\mu\text{s}$ ,  $D = 2\%$

**Total power dissipation  $P_{tot} = f(T_S)$**

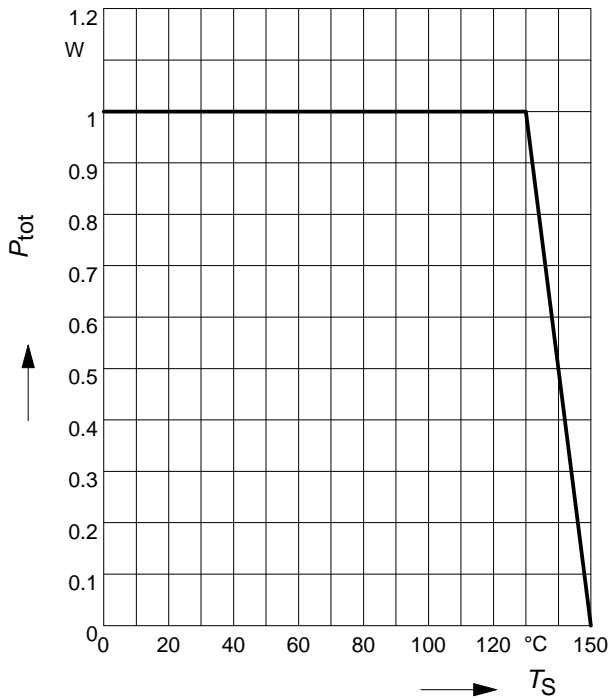

**Transition frequency  $f_T = f(I_C)$**

$V_{CE} = 5V$

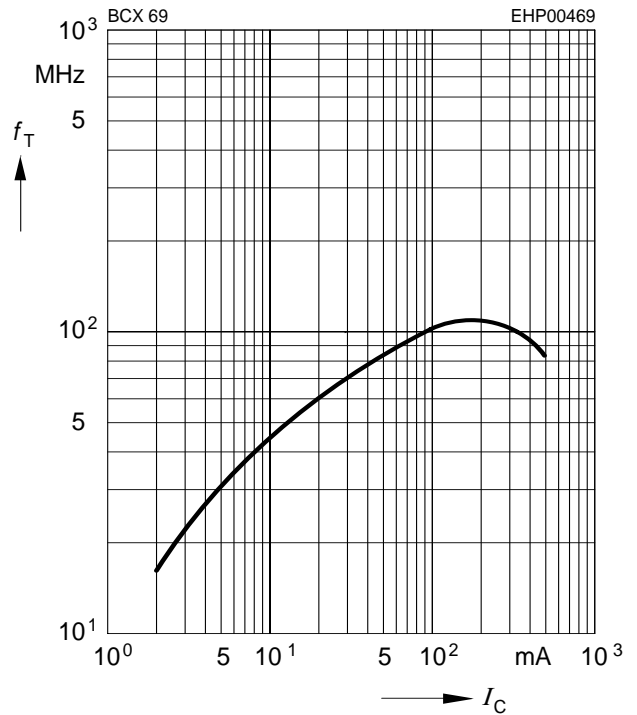

**Permissible pulse load**

$P_{totmax} / P_{totDC} = f(t_p)$

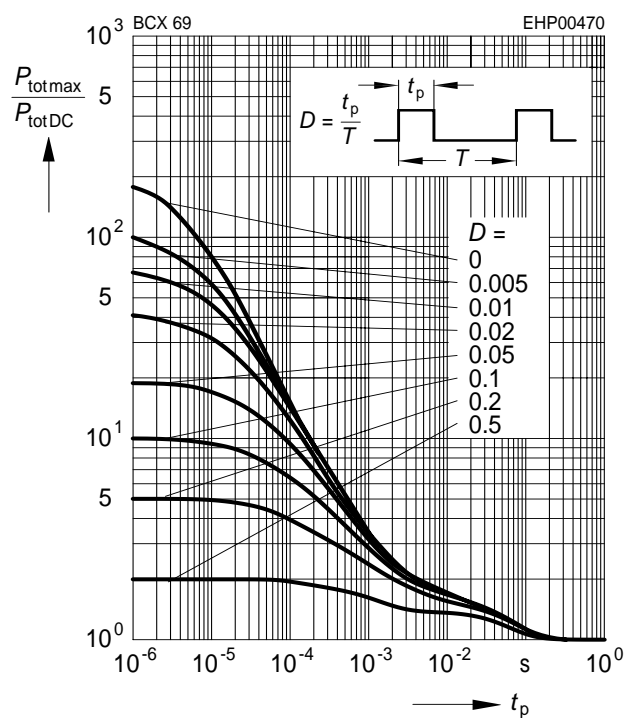

**Collector cutoff current  $I_{CBO} = f(T_A)$**

$V_{CB} = 25V$

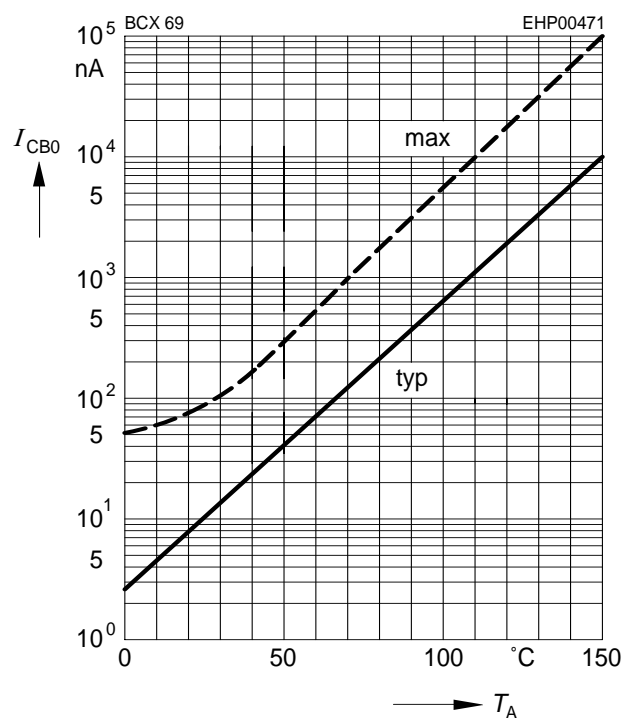

**Base-emitter saturation voltage**

$I_C = f(V_{BEsat}), h_{FE} = 10$

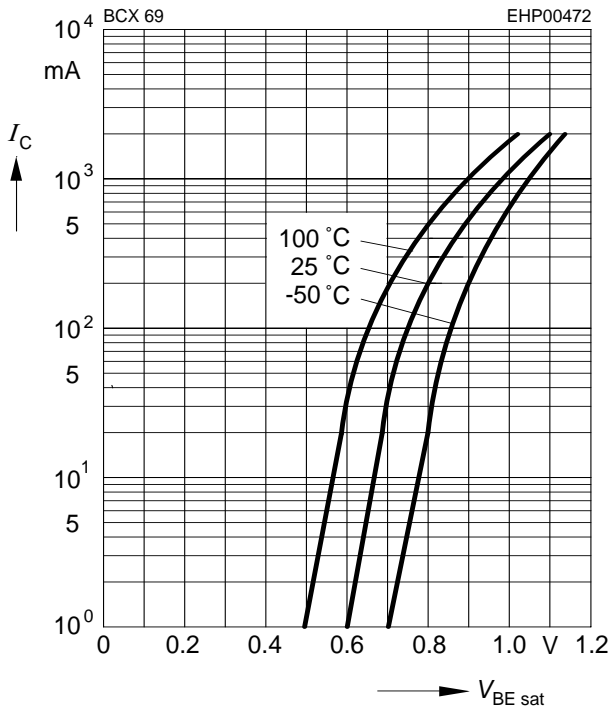

**Collector-emitter saturation voltage**

$I_C = f(V_{CEsat}), h_{FE} = 10$

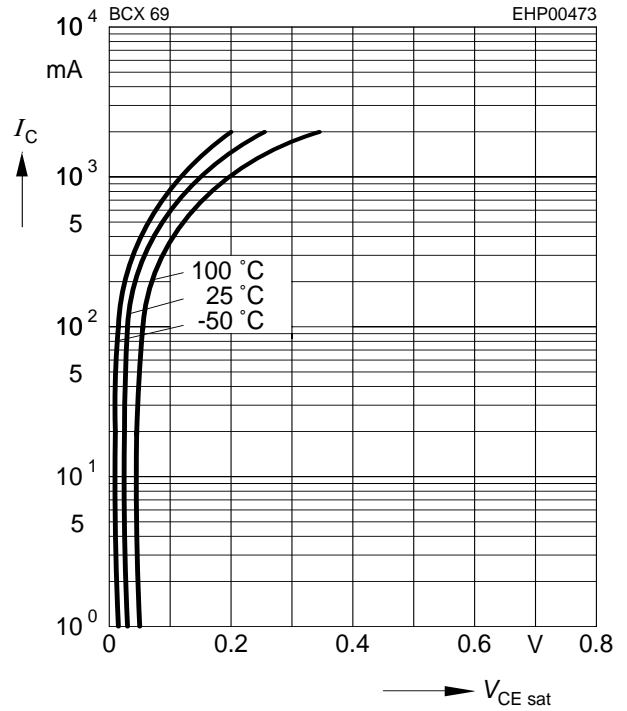

**Collector current  $I_C = f(V_{BE})$**

$V_{CE} = 1V$

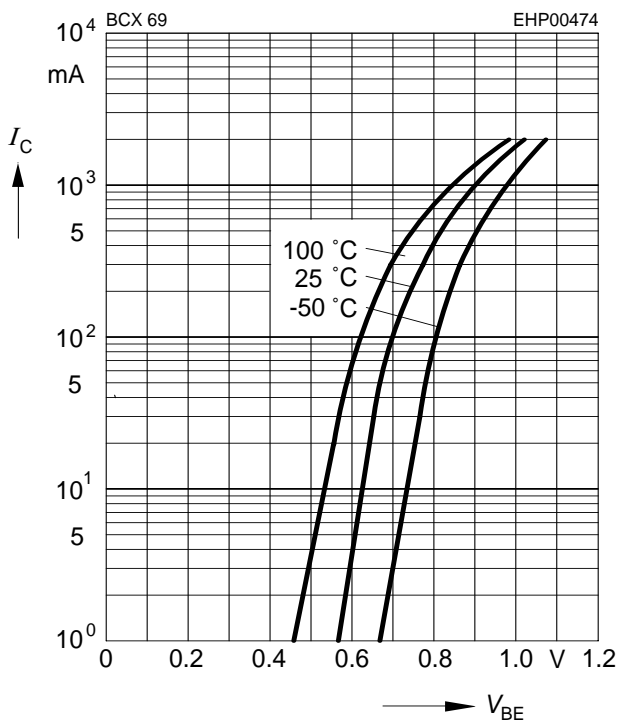

**DC current gain  $h_{FE} = f(I_C)$**

$V_{CE} = 1V$

