

GaAs PHEMT MMIC LOW NOISE HIGH IP3 AMPLIFIER, 12 - 16 GHz

Typical Applications

The HMC490LP5 is ideal for use as either a LNA or driver amplifier for:

- Point-to-Point Radios
- Point-to-Multi-Point Radios
- VSAT
- Military EW, ECM & C³I

Functional Diagram

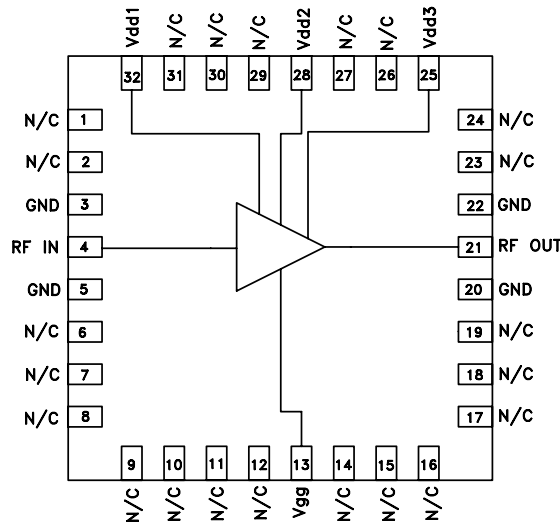

Features

- Noise Figure: 2.5 dB
- +25 dBm P1dB Output Power
- Gain: 23 dB
- +34 dBm Output IP3
- +5V Supply
- 50 Ohm Matched Input/Output
- 25 mm² Leadless QFN SMT Package

General Description

The HMC490LP5 is a high dynamic range GaAs PHEMT MMIC Low Noise Amplifier which operates between 12 and 16 GHz. The HMC490LP5 provides 23 dB of gain, 2.5 dB noise figure and an output IP3 of +34 dBm from a +5.0 V supply voltage. This versatile amplifier combines excellent, stable +25 dBm P1dB output power with very low noise figure making it ideal for receive and transmit applications. The amplifier is packaged in a leadless 5 mm x 5 mm QFN surface mount package.

Electrical Specifications, $T_A = +25^\circ C, V_{dd} = 5V, I_{dd} = 200 mA^*$

Parameter	Min.	Typ.	Max.	Units
Frequency Range	12 - 16			GHz
Gain	20	23		dB
Gain Variation Over Temperature		0.03	0.04	dB/ °C
Noise Figure		2.5	3.5	dB
Input Return Loss		8		dB
Output Return Loss		8		dB
Output Power for 1 dB Compression (P1dB)	22	25		dBm
Saturated Output Power (Psat)		27		dBm
Output Third Order Intercept (IP3)		34		dBm
Supply Current (I _{dd})(V _{dd} = 5V, V _{gg} = -0.8V Typ.)		200		mA

* Adjust V_{gg} between -2.0 to 0V to achieve I_{dd} = 200 mA typical.

**GaAs PHEMT MMIC LOW NOISE
HIGH IP3 AMPLIFIER, 12 - 16 GHz**

Broadband Gain & Return Loss

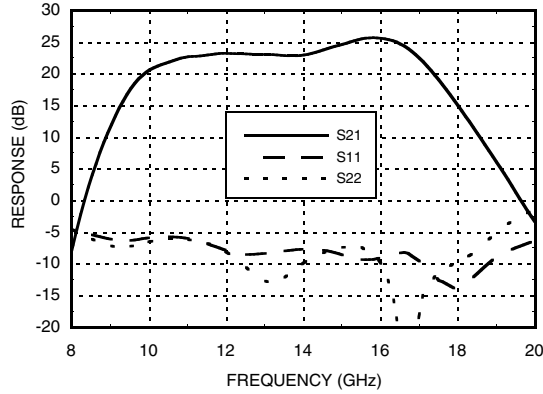

Gain vs. Temperature

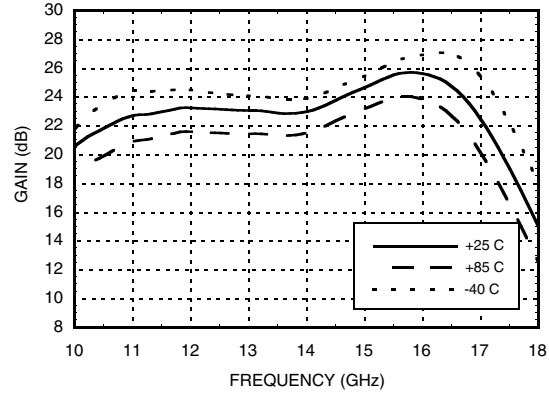

Input Return Loss vs. Temperature

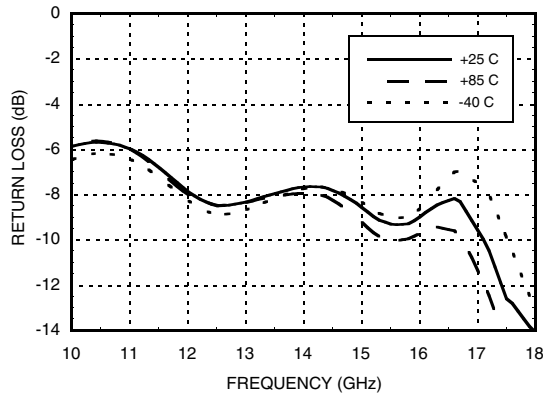

Output Return Loss vs. Temperature

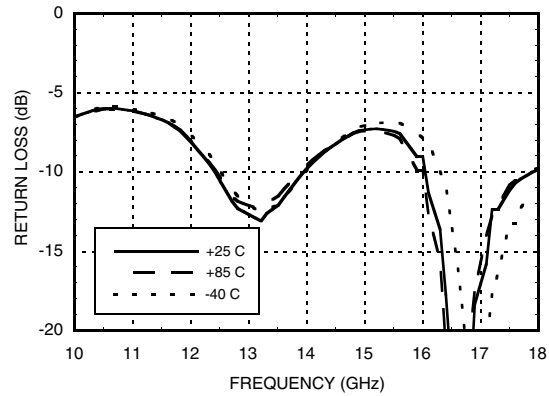

Noise Figure vs. Temperature

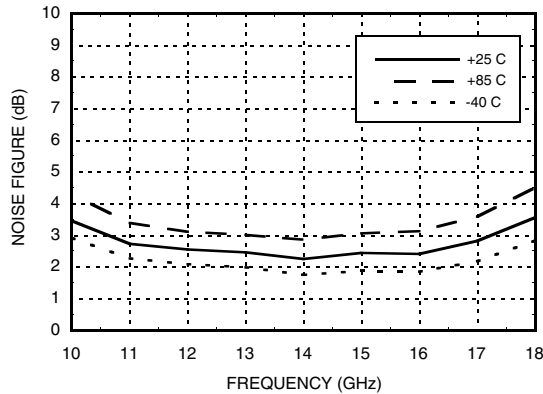

Output IP3 vs. Temperature

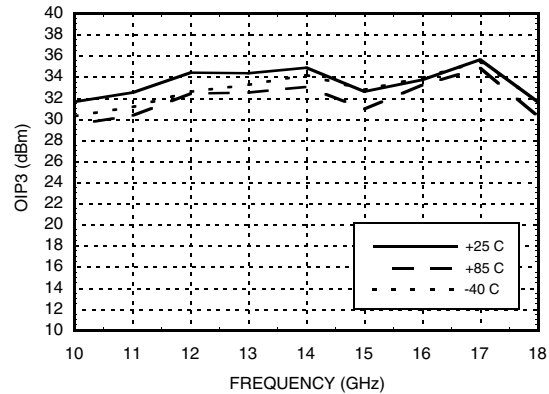

GaAs PHEMT MMIC LOW NOISE HIGH IP3 AMPLIFIER, 12 - 16 GHz

8

AMPLIFIERS - SMT

P1dB vs. Temperature

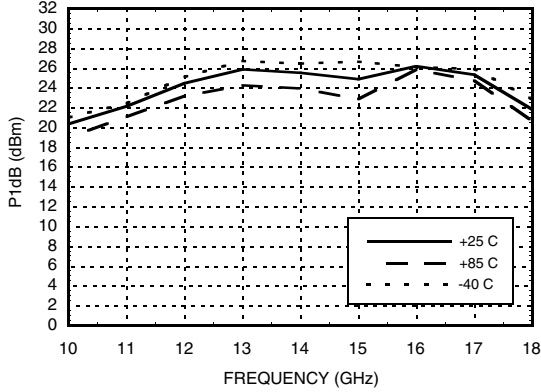

Psat vs. Temperature

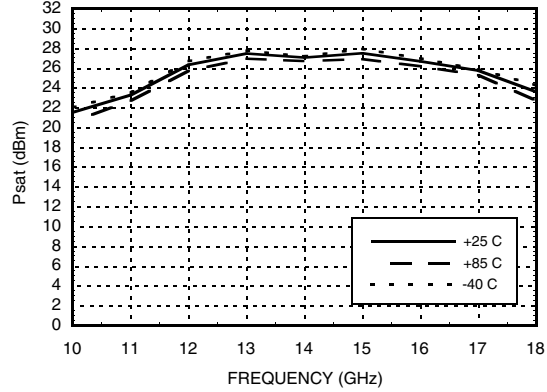

Gain, Noise Figure & OIP3 vs. Supply Voltage @ 14 GHz, Idd= 200 mA

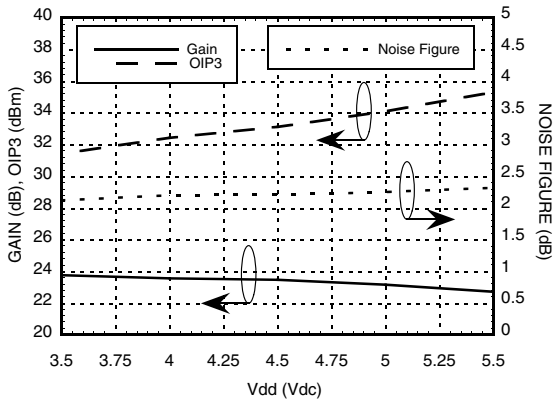

Power Compression @ 14 GHz

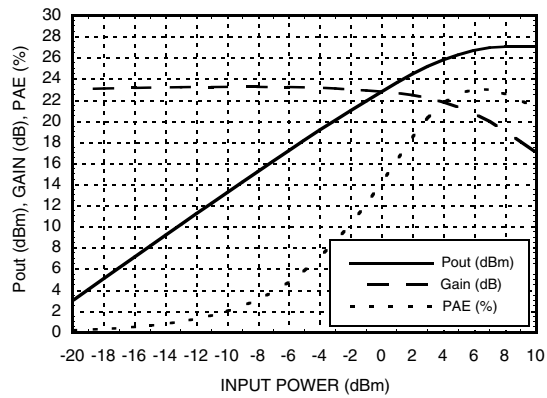

Gain, Noise Figure & IP3 vs. Supply Current @ 14 GHz, Vdd= 5V*

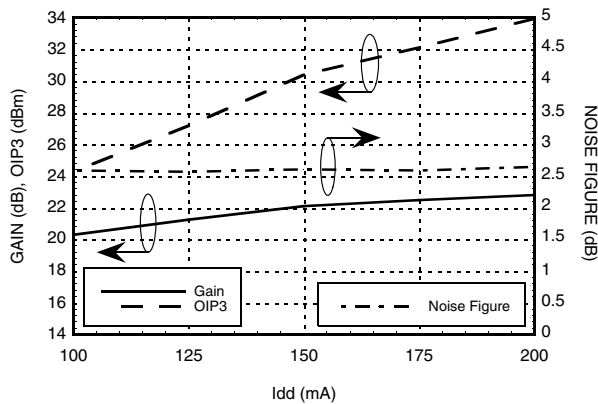

Reverse Isolation vs. Temperature

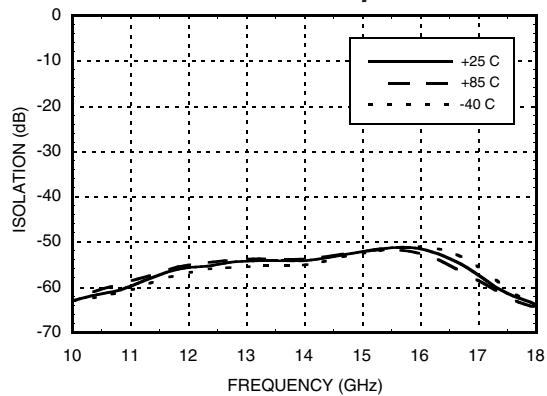

* Idd is controlled by varying Vgg

GaAs PHEMT MMIC LOW NOISE HIGH IP3 AMPLIFIER, 12 - 16 GHz

Absolute Maximum Ratings

Drain Bias Voltage (Vdd1, Vdd2, Vdd3)	+5.5 Vdc
Gate Bias Voltage (Vgg)	-4.0 to 0 Vdc
RF Input Power (RFIn)(Vdd = +5.0 Vdc)	+10 dBm
Channel Temperature	175 °C
Continuous Pdiss (T= 85 °C) (derate 29 mW/°C above 85 °C)	2.65 W
Thermal Resistance (channel to ground paddle)	34 °C/W
Storage Temperature	-65 to +150 °C
Operating Temperature	-40 to +85 °C

Typical Supply Current vs. Vdd

Vdd (Vdc)	Idd (mA)
+3.0	140
+3.5	154
+4.0	168
+4.5	188
+5.0	200
+5.5	208

Note: Amplifier will operate over full voltage ranges shown above.

Outline Drawing

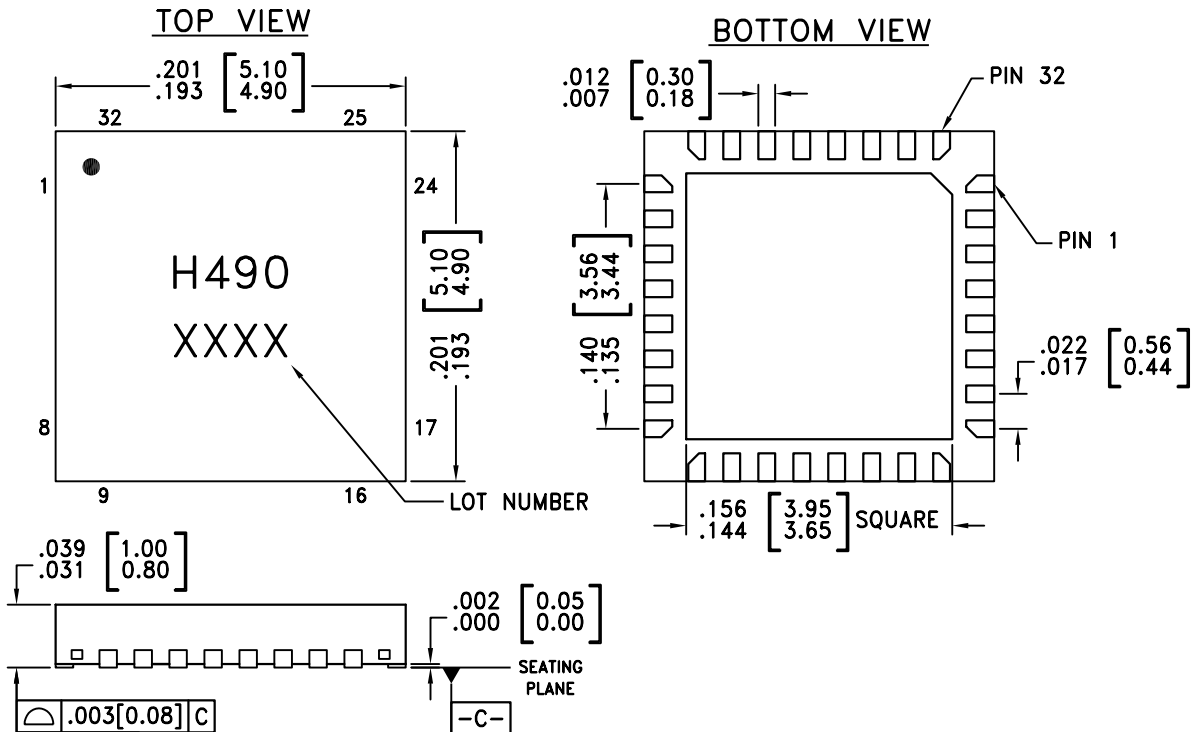

NOTES:

- ALL DIMENSIONS ARE IN INCHES [MM]
- DIE THICKNESS IS .004"
- TYPICAL BOND IS .004" SQUARE
- BACKSIDE METALLIZATION: GOLD
- BOND PAD METALLIZATION: GOLD
- BACKSIDE METAL IS GROUND.
- CONNECTION NOT REQUIRED FOR UNLABELED BOND PADS.

GaAs PHEMT MMIC LOW NOISE HIGH IP3 AMPLIFIER, 12 - 16 GHz

Pin Descriptions

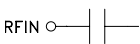
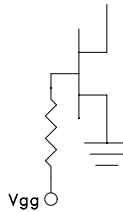
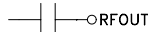
Pin Number	Function	Description	Interface Schematic
1, 2, 6-12, 14-19, 23, 24, 26, 27, 29-31	N/C	No connection. These pins may be connected to RF ground. Performance will not be affected.	
3, 5, 20, 22	GND	Package bottom must also be connected to RF/DC ground.	
4	RF IN	This pad is AC coupled and matched to 50 Ohms from 12 - 16 GHz.	
13	V _{gg}	Gate control for amplifier. Adjust to achieve I _{dd} of 200 mA. Please follow "MMIC Amplifier Biasing Procedure" Application Note. External bypass capacitors of 100 pF and 0.01 μF are required.	
21	RF OUT	This pad is AC coupled and matched to 50 Ohms from 12 - 16 GHz.	
25, 28, 32	V _{dd3} , 2, 1	Power Supply Voltage for the amplifier. External bypass capacitors of 100 pF and 0.01 μF are required.	

GaAs PHEMT MMIC LOW NOISE HIGH IP3 AMPLIFIER, 12 - 16 GHz

Evaluation PCB

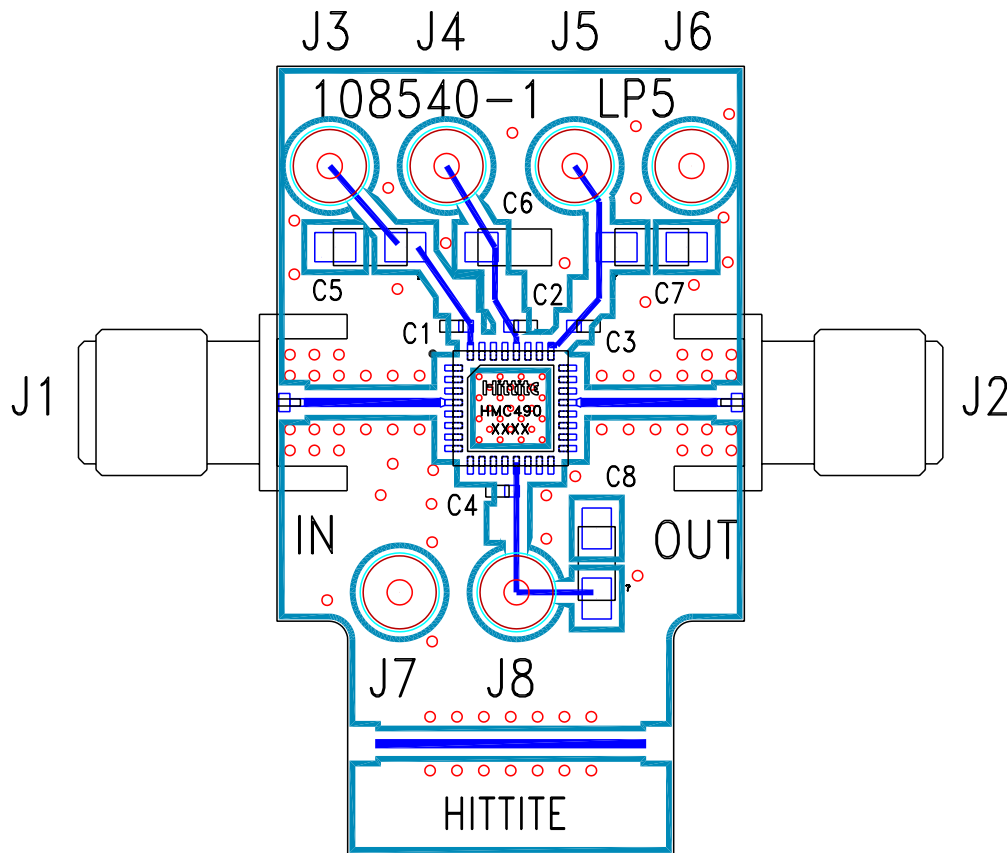

List of Materials for Evaluation PCB 108402*

Item	Description
J1 - J2	PC Mount SMA Connector
J3 - J8	DC Pin
C1 - C4	1000pF Capacitor, 0402 Pkg.
C5 - C8	4.7 μ F Capacitor, Tantalum
U1	HMC490LP5
PCB**	108540 Evaluation PCB
** Circuit Board Material: Rogers 4350	

The circuit board used in the final application should use RF circuit design techniques. Signal lines should have 50 ohm impedance while the package ground leads and package bottom should be connected directly to the ground plane similar to that shown. A sufficient number of VIA holes should be used to connect the top and bottom ground planes. The evaluation board should be mounted to an appropriate heat sink. The evaluation circuit board shown is available from Hittite upon request.

* Reference this number when ordering complete evaluation PCB.