

## GaAs MMIC x2 ACTIVE FREQUENCY MULTIPLIER, 19 - 25 GHz OUTPUT

### Typical Applications

The HMC448 is suitable for:

- Clock Generation Applications:  
SONET OC-192 & SDH STM-64
- Pt to Pt & VSAT Radios
- Test Instrumentation
- Military & Space

### Functional Diagram

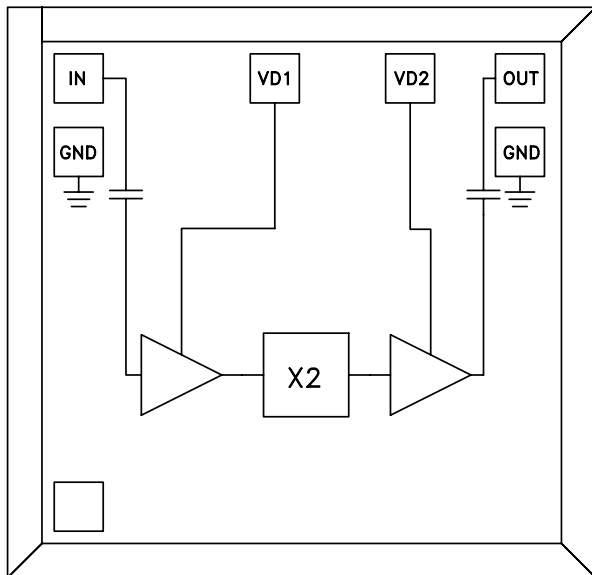

### Features

- Output Power: +11 dBm
- Wide Input Power Range: -4 to +6 dBm
- Fo, 3Fo Isolation: >20 dBc @ Fout= 20 GHz
- 100 KHz SSB Phase Noise: -135 dBc/Hz
- Single Supply: 5V @ 48 mA
- Die Size: 1.16 mm x 1.20 mm x 0.1 mm

### General Description

The HMC448 die is a x2 active broadband frequency multiplier chip utilizing GaAs PHEMT technology. When driven by a 0 dBm signal, the multiplier provides +11 dBm typical output power from 19 to 25 GHz. The Fo and 3Fo isolations are >22 dBc up to 22 GHz. This multi-rate frequency multiplier can be used in the generation of a half rate clock for 40 Gbps systems or as part of a multiplier chain to generate a full rate 40 Gbps clock. The HMC448 is also ideal for use in LO multiplier chains for Pt to Pt & VSAT Radios yielding reduced parts count vs. traditional approaches. The low additive SSB Phase Noise of -135 dBc/Hz at 100 kHz offset helps maintain good system noise performance. All data is with the chip in a 50 ohm test fixture connected via 0.076mm x 0.0127mm (3mil x 0.5mil) ribbon bonds of minimal length 0.31mm (<12mils).

### Electrical Specifications, $T_A = +25^\circ C$ , $V_{d1} = V_{d2} = 5.0V$ , 0 dBm Drive Level

| Parameter                                    | Min.       | Typ. | Max. | Min.        | Typ. | Max. | Units  |
|----------------------------------------------|------------|------|------|-------------|------|------|--------|
| Frequency Range, Input                       | 9.5 - 11.0 |      |      | 11.0 - 12.5 |      |      | GHz    |
| Frequency Range, Output                      | 19 - 22    |      |      | 22 - 25     |      |      | GHz    |
| Output Power                                 | 5          | 9    |      | 8           | 12   |      | dBm    |
| Fo Isolation (with respect to output level)  |            | 25   |      |             | 15   |      | dBc    |
| 3Fo Isolation (with respect to output level) |            | 25   |      |             | 22   |      | dBc    |
| Input Return Loss                            |            | 9    |      |             | 6    |      | dB     |
| Output Return Loss                           |            | 5    |      |             | 5    |      | dB     |
| SSB Phase Noise (100 kHz Offset)             |            | -135 |      |             | -135 |      | dBc/Hz |
| Supply Current (I <sub>dd</sub> )            |            | 48   |      |             | 48   |      | mA     |

## GaAs MMIC x2 ACTIVE FREQUENCY MULTIPLIER, 19 - 25 GHz OUTPUT

**Output Power vs. Temperature @ 0 dBm Drive Level**

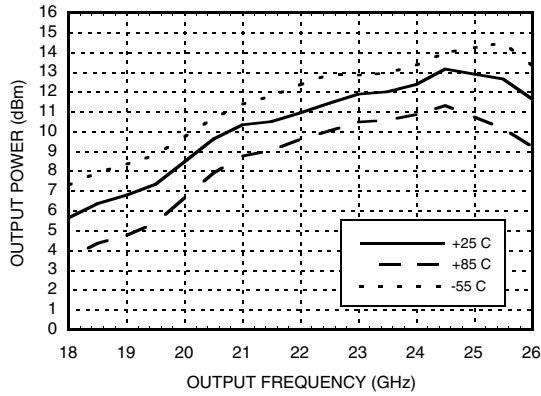

**Output Power vs. Drive Level**

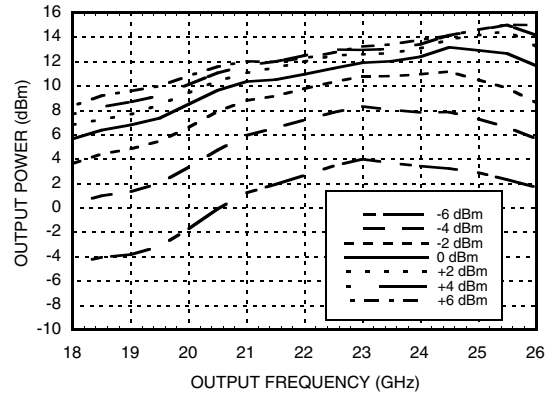

**Output Power vs. Supply Voltage @ 0 dBm Drive Level**

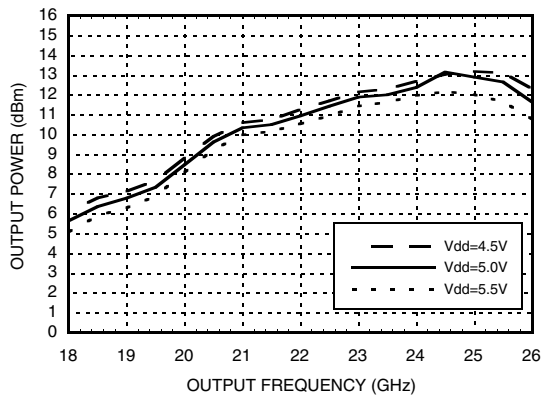

**Isolation @ 0 dBm Drive Level**

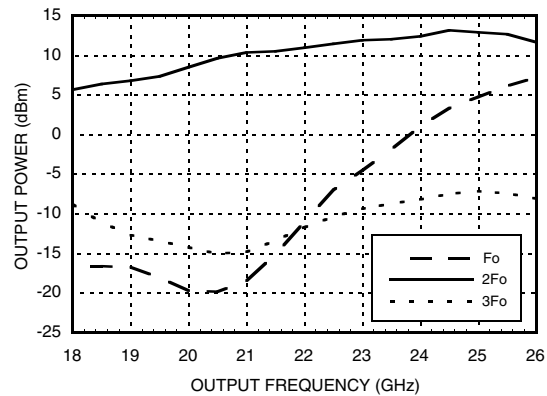

**Pin vs. Pout @ 3 Frequencies**

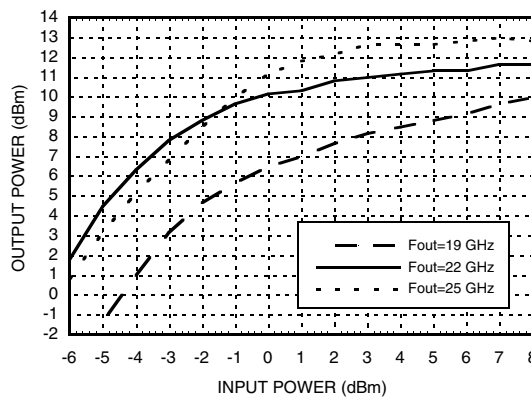

## GaAs MMIC x2 ACTIVE FREQUENCY MULTIPLIER, 19 - 25 GHz OUTPUT

**Input Return Loss vs. Temperature**

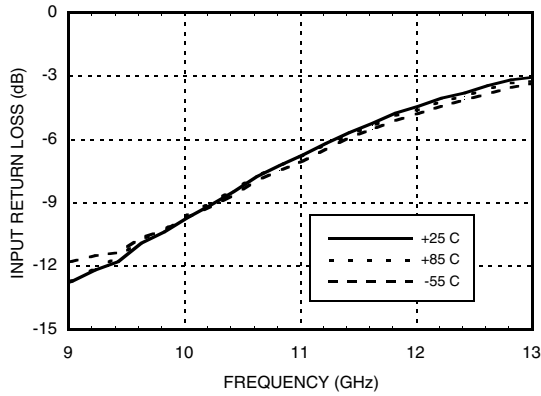

**Output Return Loss vs. Temperature**

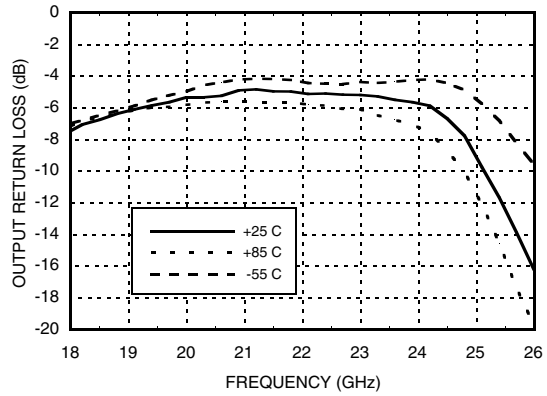

**SSB Phase Noise Performance,  
Fout = 20.4 GHz, Pin = 0 dBm**

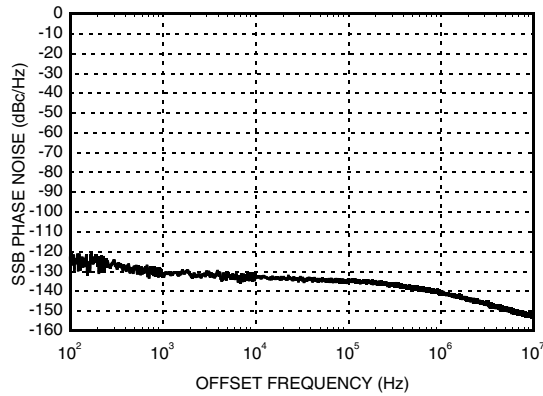

## GaAs MMIC x2 ACTIVE FREQUENCY MULTIPLIER, 19 - 25 GHz OUTPUT

### Absolute Maximum Ratings

|                                                               |                |
|---------------------------------------------------------------|----------------|
| RF Input (Vcc= +5V)                                           | +20 dBm        |
| Supply Voltage (Vd1, Vd2)                                     | +6.0 Vdc       |
| Channel Temperature                                           | 175 °C         |
| Continuous Pdiss (T= 85 °C)<br>(derate 8.3 mW/°C above 85 °C) | 744 mW         |
| Thermal Resistance<br>(junction to die bottom)                | 121 °C/W       |
| Storage Temperature                                           | -65 to +150 °C |
| Operating Temperature                                         | -55 to +85 °C  |

### Typical Supply Current vs. Vdd

| Vdd (Vdc) | Idd (mA) |
|-----------|----------|
| 4.5       | 47       |
| 5.0       | 48       |
| 5.5       | 49       |

Note: Multiplier will operate over full voltage range shown above.

### Outline Drawing

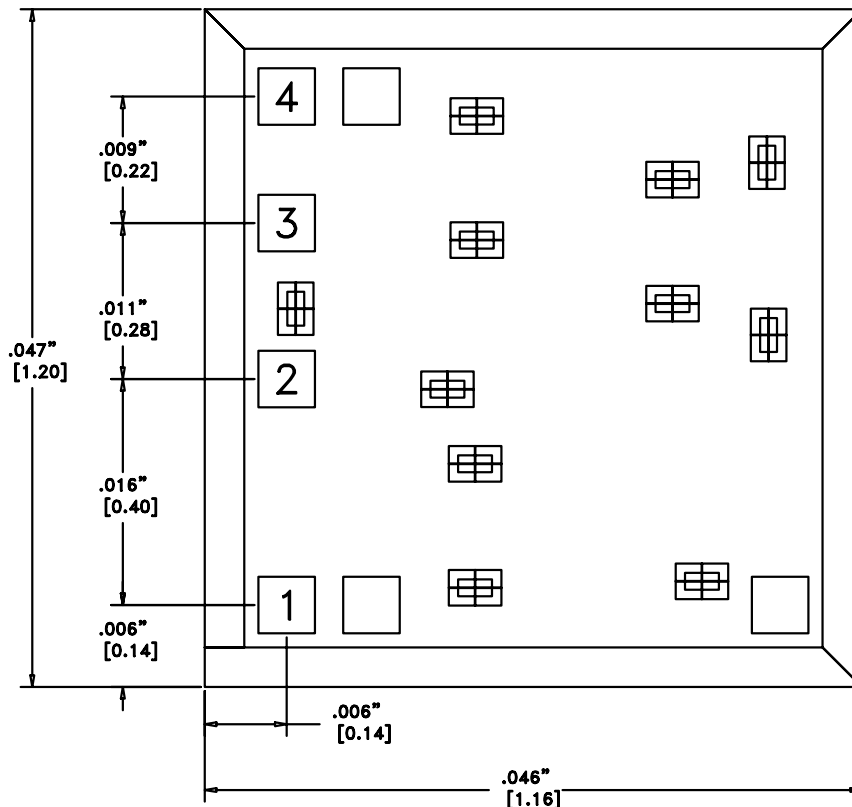



NOTES:

1. ALL DIMENSIONS ARE IN INCHES [MILLIMETERS].
2. DIE THICKNESS IS .004"
3. TYPICAL BOND PAD IS .004" SQUARE.
4. TYPICAL BOND SPACING IS .006" CENTER TO CENTER.
5. BOND PAD METALIZATION: GOLD
6. BACKSIDE METALIZATION: GOLD
7. BACKSIDE METAL IS GROUND.
8. NO CONNECTION REQUIRED FOR UNLABELED BOND PADS.

## GaAs MMIC x2 ACTIVE FREQUENCY MULTIPLIER, 19 - 25 GHz OUTPUT

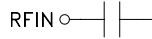
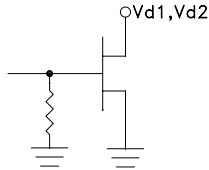
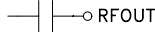
### Pad Description

| Pad Number | Function | Description                                                  | Interface Schematic                                                                 |
|------------|----------|--------------------------------------------------------------|-------------------------------------------------------------------------------------|
| 1          | RF IN    | Pin is AC coupled and matched to 50 Ohm from 9.5 - 12.5 GHz. |  |
| 2, 3       | Vd1, Vd2 | Supply voltage 5V ± 0.5V.                                    |  |
| 4          | RF OUT   | Pin is AC coupled and matched to 50 Ohm from 19 - 25 GHz.    |  |
|            | GND      | Die bottom must be connected to RF ground.                   |  |

### Assembly Diagram

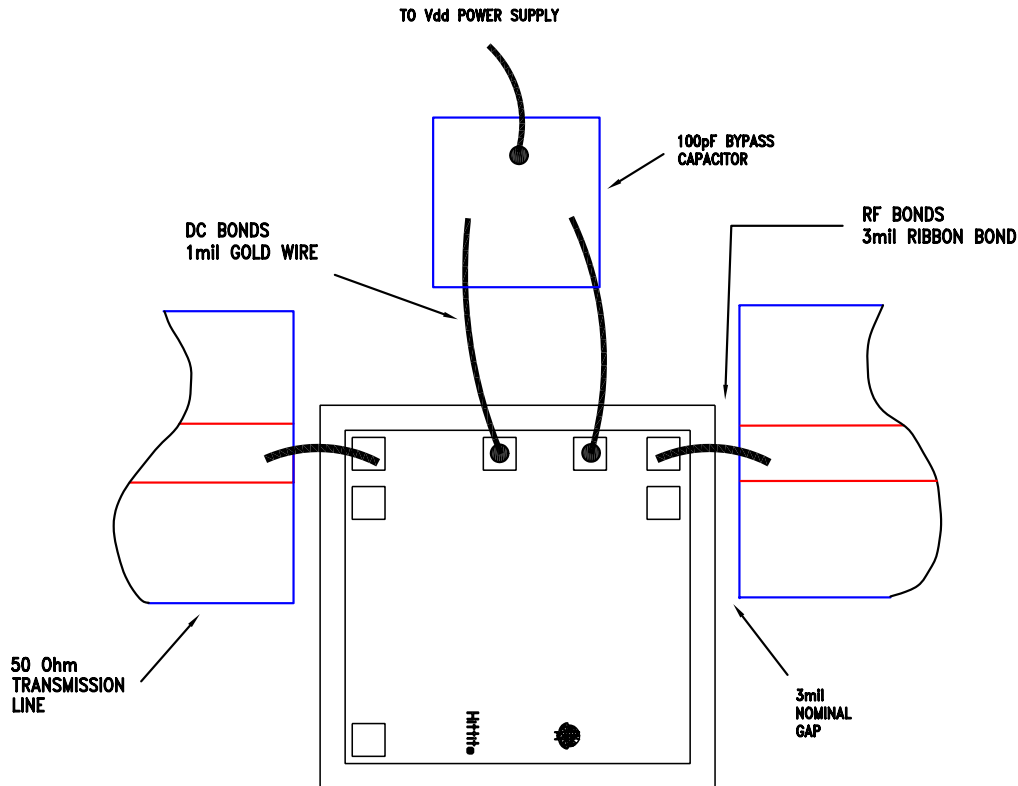

**GaAs MMIC x2 ACTIVE FREQUENCY MULTIPLIER, 19 - 25 GHz OUTPUT**

**Handling Precautions**

Follow these precautions to avoid permanent damage.

**Cleanliness:** Handle the chips in a clean environment. DO NOT attempt to clean the chip using liquid cleaning systems.

**Storage:** All bare die are placed in either Waffle or Gel based ESD protective containers, and then sealed in an ESD protective bag for shipment. Once the sealed ESD protective bag has been opened, all die should be stored in a dry nitrogen environment.

**Static Sensitivity:** Follow ESD precautions to protect against  $> \pm 250V$  ESD strikes.

**Transients:** Suppress instrument and bias supply transients while bias is applied. Use shielded signal and bias cables to minimize inductive pick-up.

**General Handling:** Handle the chip along the edges with a vacuum collet or with a sharp pair of bent tweezers. The surface of the chip has fragile air bridges and should not be touched with vacuum collet, tweezers, or fingers.

**Mounting**

The chip is back-metallized and can be die mounted with AuSn eutectic preforms or with electrically conductive epoxy. The mounting surface should be clean and flat.

**Eutectic Die Attach:** A 80/20 gold tin preform is recommended with a work surface temperature of 255 deg. C and a tool temperature of 265 deg. C. When hot 90/10 nitrogen/hydrogen gas is applied, tool tip temperature should be 290 deg. C. DO NOT expose the chip to a temperature greater than 320 deg. C for more than 20 seconds. No more than 3 seconds of scrubbing should be required for attachment.

**Epoxy Die Attach:** Apply a minimum amount of epoxy to the mounting surface so that a thin epoxy fillet is observed around the perimeter of the chip once it is placed into position. Cure epoxy per the manufacturer's schedule.

**Wire Bonding**

Ball or wedge bond with 0.025mm (1 mil) diameter pure gold wire. Thermosonic wirebonding with a nominal stage temperature of 150 deg. C and a ball bonding force of 40 to 50 grams or wedge bonding force of 18 to 22 grams is recommended. Use the minimum level of ultrasonic energy to achieve reliable wirebonds. Wirebonds should be started on the chip and terminated on the package or substrate. All bonds should be as short as possible <0.31mm (12 mils).

**Mounting & Bonding Techniques for Millimeterwave GaAs MMICs**

The die should be attached directly to the ground plane eutectically or with conductive epoxy (see HMC general Handling, Mounting, Bonding Note).

50 Ohm Microstrip transmission lines on 0.127mm (5 mil) thick alumina thin film substrates are recommended for bringing RF to and from the chip (Figure 1). If 0.254mm (10 mil) thick alumina thin film substrates must be used, the die should be raised 0.150mm (6 mils) so that the surface of the die is coplanar with the surface of the substrate.

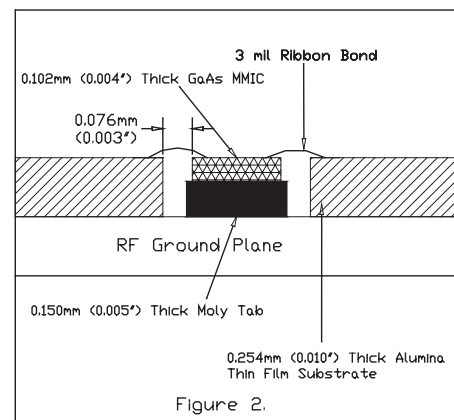
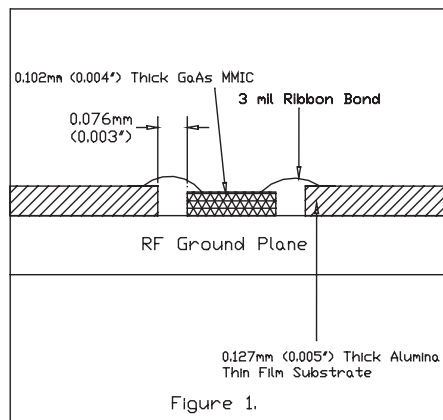

One way to accomplish this is to attach the 0.102mm (4 mil) thick die to a 0.150mm (6 mil) thick molybdenum heat spreader (moly-tab) which is then attached to the ground plane (Figure 2).

Microstrip substrates should be brought as close to the die as possible in order to minimize ribbon bond length. Typical die-to-substrate spacing is 0.076mm (3 mils). Gold ribbon of 0.075 mm (3 mil) width and minimal length <0.31 mm (<12 mils) is recommended to minimize inductance on RF, LO & IF ports.

An RF bypass capacitor should be used on the Vdd input. A 100 pF single layer capacitor (mounted eutectically or by conductive epoxy) placed no further than 0.762mm (30 Mils) from the chip is recommended.