

GaAs MMIC SP4T NON-REFLECTIVE SWITCH, DC - 4.0 GHz

Typical Applications

The HMC244G16 is ideal for:

- Telecom Infrastructure
- Military Radios, Radar & ECM
- Space Applications
- Test Instrumentation

Functional Diagram

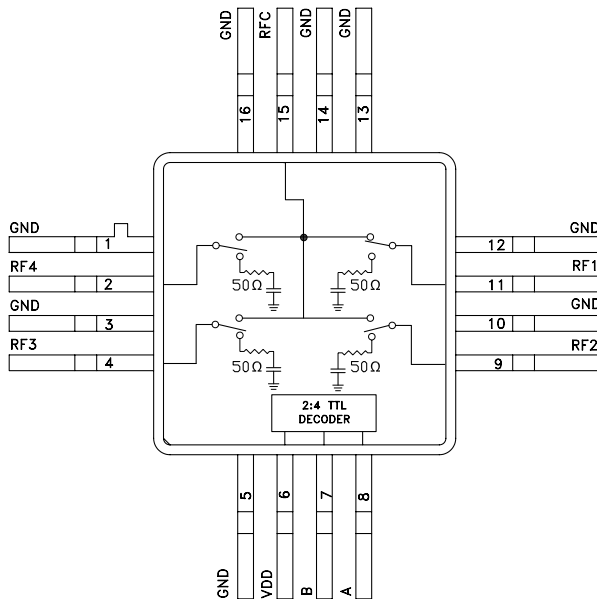

Features

- Low Insertion Loss: 0.7 dB
- Non-Reflective Design
- Integrated 2:4 TTL Decoder
- Single Positive Supply: Vdd = +5V
- 16 Lead Hermetic SMT Package

General Description

The HMC244G16 is a non-reflective SP4T switch in a 16 lead glass/metal (hermetic) package. Covering DC to 4.0 GHz, the switch offers 30~50 dB isolation and a low insertion loss of 0.7 dB through 3 GHz. A 2:4 TTL/CMOS compatible decoder is integrated on the switch requiring only 2 control lines and a positive 5V bias to select each path, replacing 8 control lines normally required by GaAs SP4T switches.

Electrical Specifications, $T_A = +25^\circ C$, With 0/+5V Control, 50 Ohm System

Parameter	Frequency	Min.	Typ.	Max.	Units
Insertion Loss	DC - 1.0 GHz		0.6	0.9	dB
	DC - 3.0 GHz		0.7	1.0	dB
	DC - 3.5 GHz		1.0	1.4	dB
	DC - 4.0 GHz		1.4	1.8	dB
Isolation	DC - 1.0 GHz	40	45		dB
	DC - 2.0 GHz	36	40		dB
	DC - 3.0 GHz	30	35		dB
	DC - 4.0 GHz	24	28		dB
Return Loss	"On State"	DC - 3.5 GHz		18	dB
		DC - 4.0 GHz		13	dB
Return Loss	RF 1 -4 "Off State"	0.2 - 4.0 GHz		10	dB
		0.5 - 4.0 GHz		15	dB
Input Power for 1 dB Compression	0.5 - 4.0 GHz	21	25		dBm
Input Third Order Intercept (Two-Tone Input Power = +7 dBm Each Tone)	0.5 - 3.0 GHz	43	47		dBm
	0.5 - 4.0 GHz	40	43		dBm
Switching Characteristics tRISE, tFALL (10/90% RF) tON, tOFF (50% CTL to 10/90% RF)	DC - 4.0 GHz		40		ns
			150		ns

For price, delivery, and to place orders, please contact Hittite Microwave Corporation:
12 Elizabeth Drive, Chelmsford, MA 01824 Phone: 978-250-3343 Fax: 978-250-3373
Order Online at www.hittite.com

GaAs MMIC SP4T NON-REFLECTIVE SWITCH, DC - 4.0 GHz

Insertion Loss

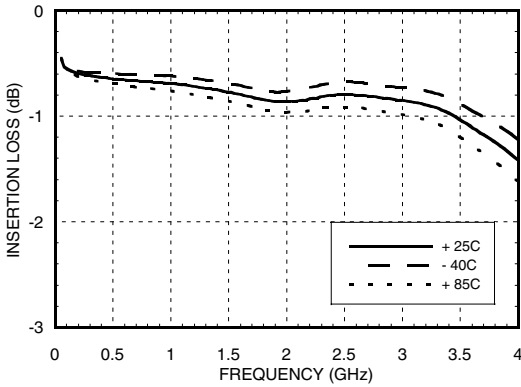

Isolation

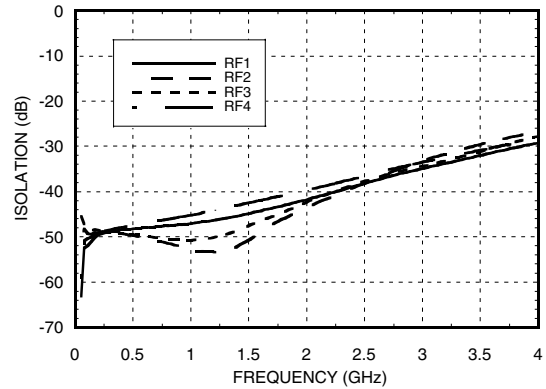

Return Loss

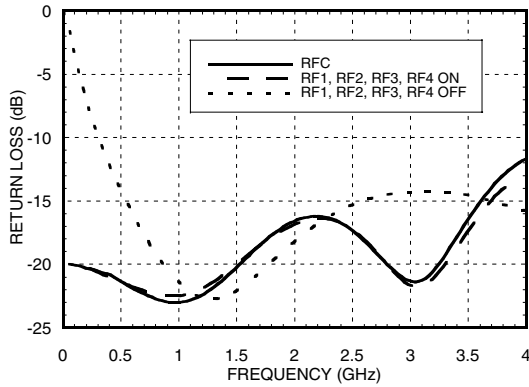

0.1 and 1 dB Input Compression Point

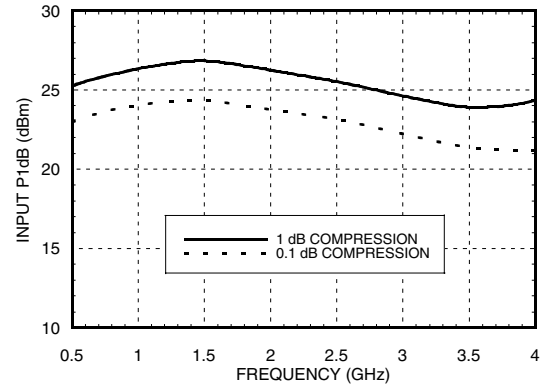

Input Third Order Intercept Point

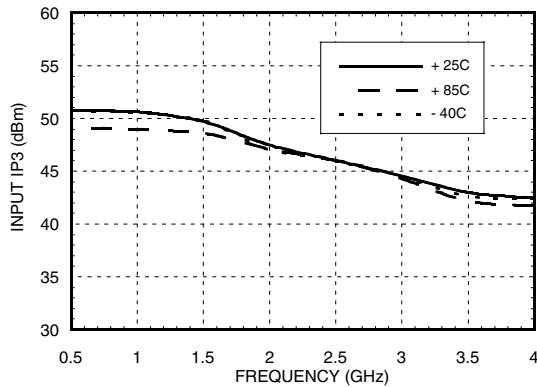

Bias Voltage & Current

Vdd Range= +5.0 Vdc ±10%		
Vdd (Vdc)	Idd (Typ) (mA)	Idd (Max) (mA)
+5.0	3.0	7.0

TTL/CMOS Control Voltages

State	Bias Condition
Low	0 to +0.8 Vdc @ 5 uA Typ.
High	+2.0 to +5.0 Vdc @ 70 uA Typ.

GaAs MMIC SP4T NON-REFLECTIVE SWITCH, DC - 4.0 GHz

Absolute Maximum Ratings

Bias Voltage Range (Port Vdd)	+7.0 Vdc
Control Voltage Range (A & B)	-0.5V to Vdd +1 Vdc
Channel Temperature	150 °C
Thermal Resistance (Insertion Loss Path)	210 °C/W
Thermal Resistance (Terminated Path)	250 °C/W
Storage Temperature	-65 to +150 °C
Operating Temperature	-40 to +85 °C
Maximum Input Power Vdd = +5 Vdc	+20 dBm (0.05 - 0.5 GHz) +27 dBm (0.5 - 3.5 GHz)

Truth Table

Control Input		Signal Path State
A	B	RF COM to:
Low	Low	RF1
High	Low	RF2
Low	High	RF3
High	High	RF4

Outline Drawing

NOTES:

- PACKAGE MATERIAL: ALUMINA LOADED BOROSILICATE GLASS.
- LEAD, BASE, COVER MATERIAL: KOVAR™ (#7052 CORNING).
- PLATING: ELECTROLYTIC GOLD 50 MICROINCHES MIN., OVER ELECTROLYTIC NICKEL 75 MICROINCHES MIN.
- DIMENSIONS ARE IN INCHES [MILLIMETERS].
- TOLERANCES: ±.005 [0.13] UNLESS OTHERWISE SPECIFIED.
- ALL GROUND LEADS AND GROUND PADDLE MUST BE SOLDERED TO PCB RF GROUND.

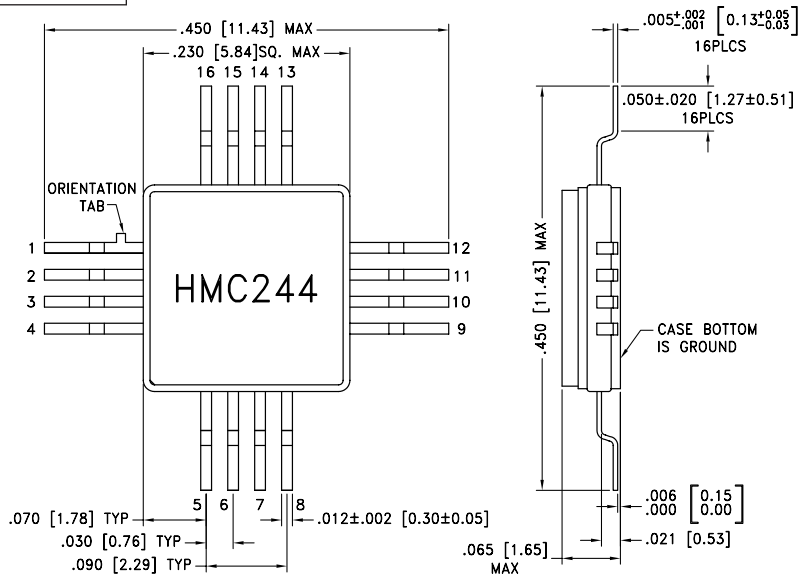

Pin Descriptions

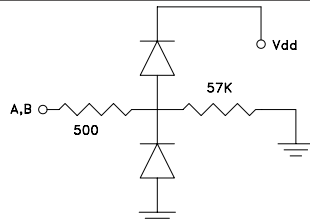
Pin Number	Function	Description	Interface Schematic
1, 3, 5, 10, 12, 13, 14, 16	GND	Package bottom has exposed metal paddle that must also be connected to PCB RF ground.	
2, 4, 9, 11, 15	RF4, RF3, RF2, RF1, RFC	These pins are DC coupled and matched to 50 Ohms. Blocking capacitors are required.	
6	Vdd	Supply Voltage +5.0 Vdc ±10%	
7	B	See truth table and control voltage table.	
8	A	See truth table and control voltage table.	

For price, delivery, and to place orders, please contact Hittite Microwave Corporation:
12 Elizabeth Drive, Chelmsford, MA 01824 Phone: 978-250-3343 Fax: 978-250-3373
Order Online at www.hittite.com

GaAs MMIC SP4T NON-REFLECTIVE SWITCH, DC - 4.0 GHz

Evaluation PCB

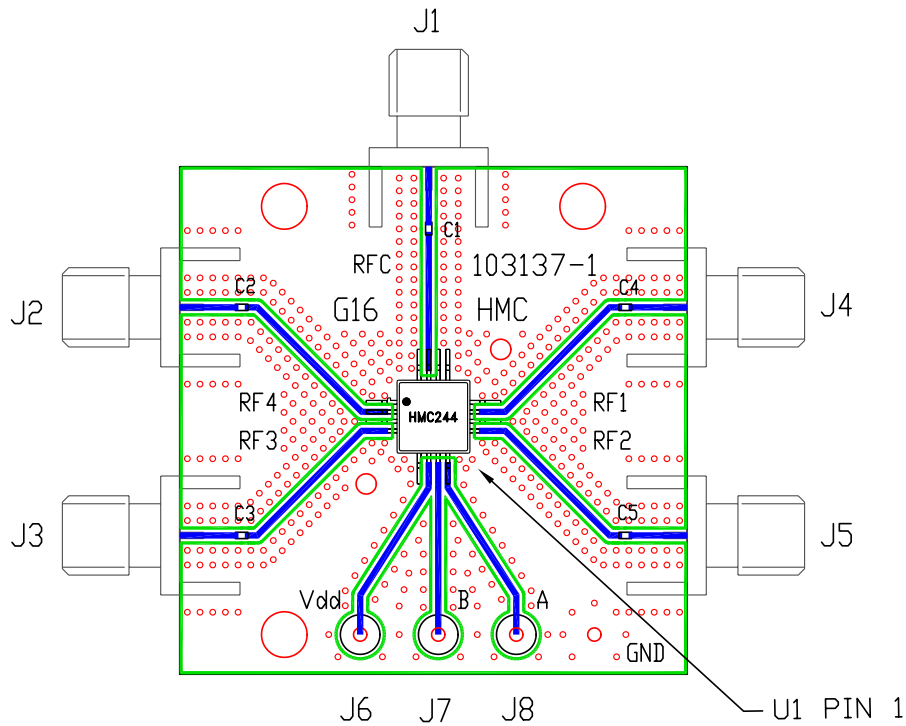

List of Material

Item	Description
J1 - J5	PC Mount SMA RF Connector
J6 - J8	DC Pin
C1 - C5	330 pF Capacitors, 0402 Pkg.
U1	HMC244G16 SP4T Switch
PCB*	103137 Evaluation PCB
* Circuit Board Material: Rogers 4350	

The circuit board used in the final application should be generated with proper RF circuit design techniques. Signal lines at the RF port should have 50 ohm impedance and the package ground leads and package bottom should be connected directly to the ground plane similar to that shown above. The evaluation circuit board shown above is available from Hittite Microwave Corporation upon request.