

ICTE5.0 THRU ICTE15C SERIES

TRANSZORB™ TRANSIENT VOLTAGE SUPPRESSOR
Stand-off Voltage - 5.0 to 15 Volts Peak Pulse Power - 1500 Watts

FEATURES

- ◆ Plastic package has Underwriters Laboratory Flammability Classification 94V-0
- ◆ Glass passivated junction
- ◆ 1500W Peak pulse power capability with a 10/1000µs waveform, repetition rate (duty cycle): 0.05%
- ◆ Excellent clamping capability
- ◆ Low incremental surge resistance
- ◆ Fast response time: typically less than 1.0ps from 0 Volts to $V_{(BR)}$ for uni-directional and 5.0ns for bi-directional
- ◆ Ideal for data and bus line applications
- ◆ High temperature soldering guaranteed: 265°C/10 seconds, 0.375" (9.5mm) lead length, 5lbs. (2.3 kg) tension
- ◆ Includes 1N6373 thru 1N6385



Case Style 1.5KE

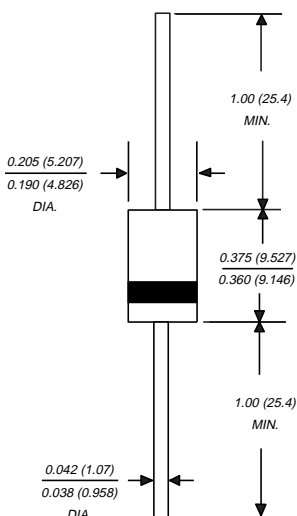

Dimensions in inches and (millimeters)

MECHANICAL DATA

Case: Molded plastic over a passivated junction

Terminals: Plated Axial leads, solderable per MIL-STD-750, Method 2026

Polarity: For uni-directional types the color band denotes the cathode, which is positive with respect to the anode under normal TVS operation

Mounting Position: Any

Weight: 0.045 ounce, 1.2 grams

MAXIMUM RATINGS AND CHARACTERISTICS

Ratings at 25°C ambient temperature unless otherwise specified.

	SYMBOL	VALUE	UNITS
Peak pulse power dissipation with a 10/1000µs waveform (NOTE 1, FIG. 1)	PPPM	Minimum 1500	Watts
Steady state power dissipation, $T_L = 75^\circ\text{C}$ at lead lengths 0.375" (9.5mm)	PM(AV)	6.5	Watts
Peak pulse current with a 10/1000µs waveform (NOTE 1, FIG. 3)	I _{PPM}	SEE TABLE 1 & 2	Amps
Peak forward surge current, 8.3ms single half sine-wave superimposed on rated load for uni-directional only (JEDEC Method) (NOTE 2)	I _{FSM}	200	Amps
Maximum instantaneous forward voltage at 100A for uni-directional only	V _F	3.5	Volts
Operating junction and storage temperature range	T _J , T _{STG}	-55 to +175	°C

NOTES:

- (1) Non-repetitive current pulse, per Fig. 3 and derated above $T_A = 25^\circ\text{C}$ per Fig. 2
- (2) 8.3ms single half sine-wave, duty cycle=4 pulses per minute maximum

ELECTRICAL CHARACTERISTICS at 25°C (JEDEC REGISTERED DATA) TABLE 1

JEDEC TYPE NUMBER	GENERAL SEMICONDUCTOR PART NUMBER	STAND-OFF VOLTAGE V _{WM} (VOLTS)	MINIMUM ⁽³⁾ BREAKDOWN VOLTAGE at 1.0mA. V _(BR) (VOLTS)	MAXIMUM REVERSE LEAKAGE at V _{WM} I _D (μA)	MAXIMUM CLAMPING VOLTAGE at I _{PP} = 1.0A V _C (VOLTS)	MAXIMUM CLAMPING VOLTAGE at I _{PP} = 10A V _C (VOLTS)	MAXIMUM PEAK PULSE CURRENT I _{PP} (Amps)
1N6373 ⁽²⁾	ICTE-5 ⁽²⁾	5.0	6.0	300	7.1	7.5	160
1N6374	ICTE-8	8.0	9.4	25.0	11.3	11.5	100
1N6375	ICTE-10	10.0	11.7	2.0	13.7	14.1	90
1N6376	ICTE-12	12.0	14.1	2.0	16.1	16.5	70
1N6377	ICTE-15	15.0	17.6	2.0	20.1	20.6	60

ELECTRICAL CHARACTERISTICS AT 25°C (JEDEC REGISTERED DATA) TABLE 2

JEDEC TYPE NUMBER	GENERAL SEMICONDUCTOR PART NUMBER	STAND-OFF VOLTAGE V _{WM} (VOLTS)	MINIMUM ⁽³⁾ BREAKDOWN VOLTAGE at 1.0mA. V _(BR) (VOLTS)	MAXIMUM REVERSE LEAKAGE at V _{WM} I _D (μA)	MAXIMUM CLAMPING VOLTAGE at I _{PP} = 1A V _C (VOLTS)	MAXIMUM CLAMPING VOLTAGE at I _{PP} = 10A V _C (VOLTS)	MAXIMUM PEAK PULSE CURRENT I _{PP} (Amps)
1N6382	ICTE-8C	8.0	9.4	50.0	11.4	11.6	100
1N6383	ICTE-10C	10.0	11.7	2.0	14.1	14.5	90
1N6384	ICTE-12C	12.0	14.1	2.0	16.7	17.1	70
1N6385	ICTE-15C	15.0	17.6	2.0	20.8	21.4	60

NOTES:

- (1) " C " Suffix indicates bi-directional
- (2) ICTE-5 and 1N6373 are not available as bi-directional
- (3) The minimum breakdown voltage as shown takes into consideration the ±1 Volt tolerance normally specified for power supply regulation on most integrated circuit manufacturers data sheets. Please consult factory for devices that require reduced clamping voltages where tighter regulated power supply voltages are employed.
- (4) Clamping Factor: 1.33 at full I_O rated power; 1.20 at 50% rated power; Clamping Factor: the ratio of the actual V_C (Clamping Voltage) to the V_(BR) (Breakdown Voltage) as measured on a specific device.

RATINGS AND CHARACTERISTIC CURVES ICTE5.0 THRU ICTE15C SERIES

FIG. 1 - PEAK PULSE POWER RATING CURVE

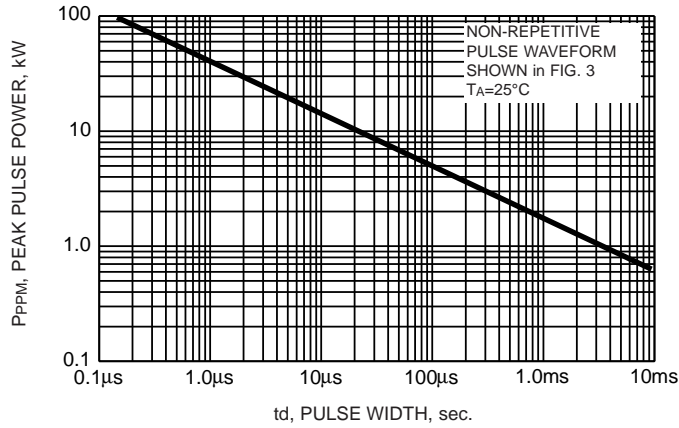

FIG. 2 - PULSE DERATING CURVE

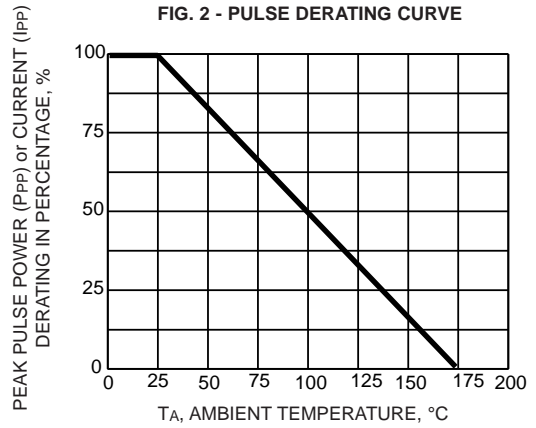

FIG. 3 - PULSE WAVEFORM

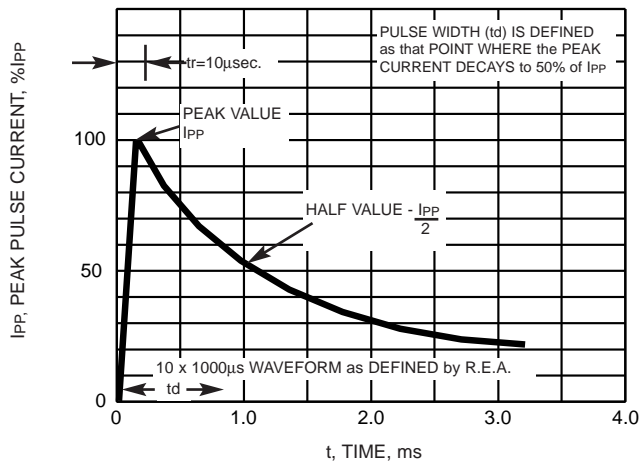
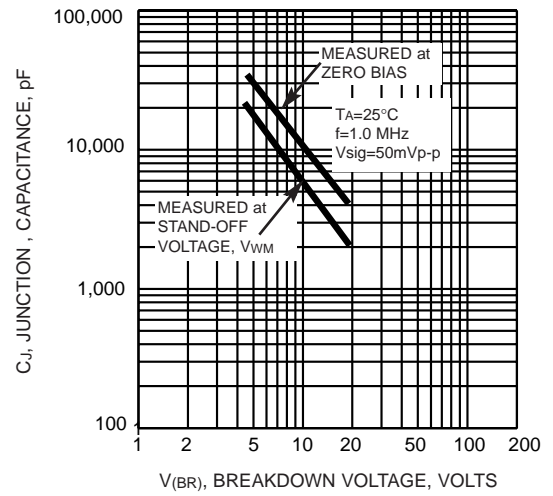

FIG. 4 - TYPICAL JUNCTION CAPACITANCE UNI-DIRECTIONAL TYPE



RATINGS AND CHARACTERISTIC CURVES ICTE5.0 THRU ICTE15C SERIES

**FIG. 5 - TYPICAL JUNCTION CAPACITANCE
BIDIRECTIONAL TYPE**

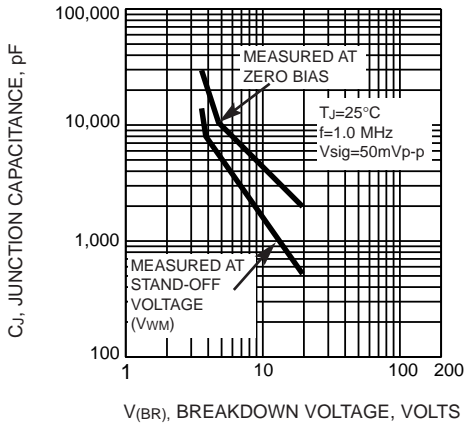

FIG. 6 - MAXIMUM NON-REPETITIVE PEAK FORWARD SURGE CURRENT

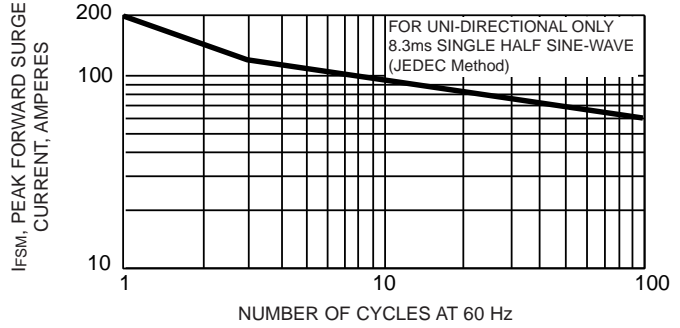

FIG. 7 - TYPICAL CHARACTERISTIC CLAMPING VOLTAGE

