

# 8-bit Proprietary Microcontroller

CMOS

## F<sup>2</sup>MC-8L MB89620 Series

MB89623/T623/V623/625/P625/W625/T625/V625/626/627/P627/W627  
MB89PV620

### ■ DESCRIPTION

The MB89620 series has been developed as a general-purpose version of the F<sup>2</sup>MC\*-8L family consisting of proprietary 8-bit, single-chip microcontrollers.

In addition to the F<sup>2</sup>MC-8L CPU core which can operate at low voltage but at high speed, the microcontrollers contain a variety of peripheral functions such as timers, serial interfaces, an A/D converter, and an external interrupt.

The MB89620 series is applicable to a wide range of applications from welfare products to industrial equipment, including portable devices.

\*: F<sup>2</sup>MC stands for FUJITSU Flexible Microcontroller.

### ■ FEATURES

- Various package options
  - Three types of QFP packages (1-mm, 0.65-mm, or 0.5-mm lead pitch)
  - SDIP packages
- High-speed processing at low voltage
  - Minimum execution time: 0.4  $\mu$ s/3.5 V, 0.8  $\mu$ s/2.7 V
- F<sup>2</sup>MC-8L family CPU core
  - Instruction set optimized for controllers
    - Multiplication and division instructions
    - 16-bit arithmetic operations
    - Test and branch instructions
    - Bit manipulation instructions, etc.
- Four types of timers
  - 8-bit PWM timer (also usable as a reload timer)
  - 8-bit pulse width count timer (Continuous measurement capable, applicable to remote control, etc.)
  - 16-bit timer/counter
  - 20-bit time-base timer
- Two serial interfaces
  - Switchable transfer direction allows communication with various equipment.
- 8-bit A/D converter
  - Sense mode function enabling comparison at 5  $\mu$ s
  - Activation by an external input capable

(Continued)

# MB89620 Series

(Continued)

- External interrupt: 4 channels  
Four channels are independent and capable of wake-up from low-power consumption modes (with an edge detection function).
- Low-power consumption modes  
Stop mode (Oscillation stops to minimize the current consumption.)  
Sleep mode (The CPU stops to reduce the current consumption to approx. 1/3 of normal.)
- Bus interface functions  
Including hold and ready functions

## ■ PACKAGE

64-pin Plastic SH-DIP

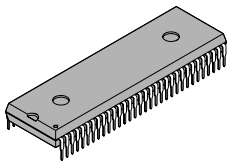

(DIP-64P-M01)

64-pin Plastic SQFP

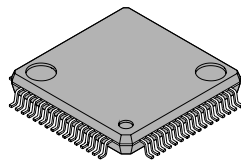

(FPT-64P-M03)

64-pin Plastic QFP

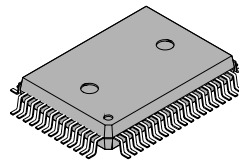

(FPT-64P-M06)

64-pin Plastic QFP

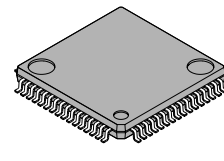

(FPT-64P-M09)

64-pin Ceramic SH-DIP

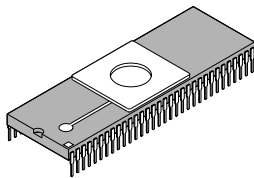

(DIP-64C-A06)

64-pin Ceramic MDIP

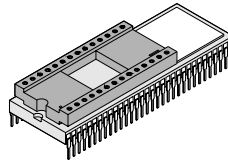

(MDP-64C-P02)

64-pin Ceramic MQFP

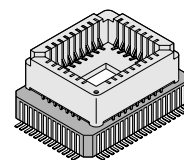

(MQP-64C-P01)

# MB89620 Series

## ■ PRODUCT LINEUP

Part number Parameter	MB89623	MB89625	MB89626	MB89627	MB89P625 MB89W625	MB89P627 MB89W627	MB89T623 MB89V623	MB89T625 MB89V625	MB89PV620
Classification	Mass production products (mask ROM products)				One-time PROM products/EPROM products		External ROM products/For evaluation and development		Piggyback/ evaluation product for evaluation and development
ROM size	8 K × 8 bits (internal mask ROM)	16 K × 8 bits (internal mask ROM)	24 K × 8 bits (internal mask ROM)	32 K × 8 bits (internal mask ROM)	16 K × 8 bits (internal PROM, programming with general- purpose EPROM programmer)	32 K × 8 bits (internal PROM, programming with general- purpose EPROM programmer)	External ROM		32 K × 8 bits (external ROM)
RAM size	256 × 8 bits	512 × 8 bits	768 × 8 bits	1 K × 8 bits	512 × 8 bits	1 K × 8 bits	256 × 8 bits	512 × 8 bits	1K × 8 bits
CPU functions	Number of instructions: Instruction bit length: Instruction length: Data bit length: Minimum execution time: Interrupt processing time:				136 8 bits 1 to 3 bytes 1, 8, 16 bits 0.4 μs /10 MHz 3.6 μs/10 MHz				
Ports	Input ports: Output ports (N-ch open-drain): I/O ports (N-ch open-drain) Output ports (CMOS): I/O ports (CMOS): Total:				5 (4 ports also serve as peripherals.) 8 (All also serve as peripherals.) 8 (4 ports also serve as peripherals.) 8 (All also serve as bus control pins.) 24 (All also serve as bus pins or peripherals.) 53				
8-bit PWM timer	8-bit reload timer operation (toggled output capable, operating clock cycle: 0.4 μs to 3.3 ms) 8-bit resolution PWM operation (conversion cycle: 102 μs to 839 ms)								
8-bit pulse width count timer	8-bit timer operation (overflow output capable, operating clock cycle: 0.4 to 12.8 μs) 8-bit reload timer operation (toggled output capable, operating clock cycle: 0.4 to 12.8 μs) 8-bit pulse width measurement operation (Continuous measurement "H" pulse width/"L" pulse width/from ↑ to ↑/from ↓ to ↓ capable)								
16-bit timer/ counter	16-bit timer operation (operating clock cycle: 0.4 μs) 16-bit event counter operation (Rising/falling/both edges selectability)								
8-bit serial I/O 1, 8-bit serial I/O 2	8 bits LSB first/MSB first selectability One clock selectable from four transfer clocks (one external shift clock, three internal shift clocks: 0.8 μs, 3.2 μs, 12.8 μs)								
8-bit A/D converter	8-bit resolution × 8 channels A/D conversion mode (conversion time: 18 μs) Sense mode (conversion time: 5 μs) Continuous activation by an external activation or an internal timer capable Reference voltage input								

(Continued)

# MB89620 Series

(Continued)

Part number Parameter	MB89623	MB89625	MB89626	MB89627	MB89P625 MB89W625	MB89P627 MB89W627	MB89T623 MB89V623	MB89T625 MB89V625	MB89PV620
External interrupt	4 independent channels (edge selection, interrupt vector, source flag) Rising edge/falling edge selectability Used also for wake-up from stop/sleep mode. (Edge detection is also permitted in stop mode.)								
Standby modes	Sleep mode, stop mode								
Process	CMOS								
Operating voltage*	2.2 V to 6.0 V				2.7 V to 6.0 V				
EPROM for use	—								MBM27C256A -20

\*: Varies with conditions such as the operating frequency. (See section “■ Electrical Characteristics.”)

## ■ PACKAGE AND CORRESPONDING PRODUCTS

Package	MB89623 MB89625 MB89T623 MB89T625	MB89626 MB89627 MB89P625	MB89P627	MB89W625 MB89W627	MB89V623 MB89V625	MB89PV620
DIP-64P-M01	○	○	○	×	○	×
DIP-64C-A06	×	×	×	○	×	×
FPT-64P-M03	○	×	×	×	×	×
FPT-64P-M06	○	○	○	×	×	×
FPT-64P-M09	○	○	○	×	×	×
MDP-64C-P02	×	×	×	×	×	○
MQP-64C-P01	×	×	×	×	×	○

○: Available    ×: Not available

\*: Lead pitch converter sockets (manufacturer: Sun Hayato Co., Ltd.) are available.

64SD-64QF2-8L: For conversion from DIP-64P-M01 or DIP-64C-A06 to FPT-64P-M03

64SD-64SQF-8L: For conversion from DIP-64P-M01 or DIP-64C-A06 to FPT-64P-M09

Inquiry: Sun Hayato Co., Ltd. : TEL 81-3-3802-5760

Note: For more information about each package, see section “■ Package Dimensions.”

## ■ DIFFERENCES AMONG PRODUCTS

### 1. Memory Size

Before evaluating using the piggyback product, verify its differences from the product that will actually be used. Take particular care on the following points:

- On the MB89623, MB89T623, and MB89V623, the upper half of each register bank cannot be used.
- On the MB89P627, the program area starts from address 8006<sub>H</sub> but on the MB89PV620 and MB89627 starts from 8000<sub>H</sub>.

(On the MB89P627, addresses 8000<sub>H</sub> to 8006<sub>H</sub> comprise the option setting area, option settings can be read by reading these addresses. On the MB89PV620 and MB89627, addresses 8000<sub>H</sub> to 8006<sub>H</sub> could also be used as a program ROM. However, do not use these addresses in order to maintain compatibility of the MB89P627A.)

- The stack area, etc., is set at the upper limit of the RAM.
- The external area is used.

### 2. Current Consumption

- In the case of the MB89PV620, add the current consumed by the EPROM which is connected to the top socket.
- When operated at low speed, the product with an OTPROM (one-time PROM) or an EPROM will consume more current than the product with a mask ROM.

However, the current consumption in sleep/stop modes is the same. (For more information, see section “■ Electrical Characteristics”.)

### 3. Mask Options

Functions that can be selected as options and how to designate these options vary by the product.

Before using options check section “■ Mask Options.”

Take particular care on the following points:

- A pull-up resistor cannot be set for P40 to P47 on the MB89P625, MB89W625, MB89P627, and MB89W627.
- A pull-up resistor is not selectable for P50 to P57 when the A/D converter is used.
- Options are fixed on the MB89PV620.

## ■ CORRESPONDENCE BETWEEN THE MB89620 AND MB89620R SERIES

- The MB89620R series is the reduction version of the MB89620 series. For their differences, refer to the MB89620R series data sheet.
- The MB89620 and MB89620R series consist of the following products:

MB89620 series	MB89623	MB89625	MB89626	MB89P625	MB89P627	MB89W625	MB89W627	MB89PV620
MB89620R series	MB89623R	MB89625R	MB89626R	—	—	—	—	—

# MB89620 Series

## PIN ASSIGNMENT

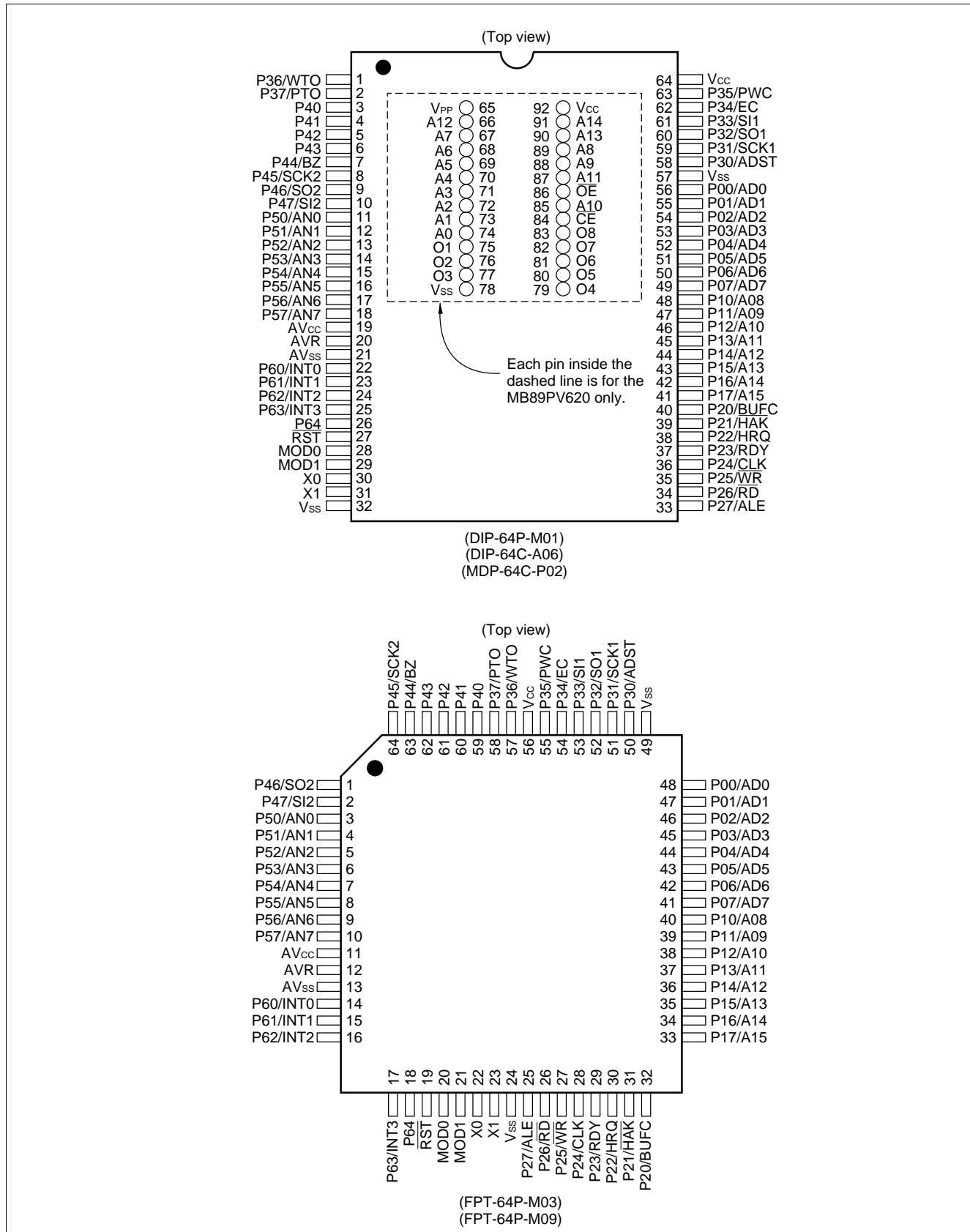

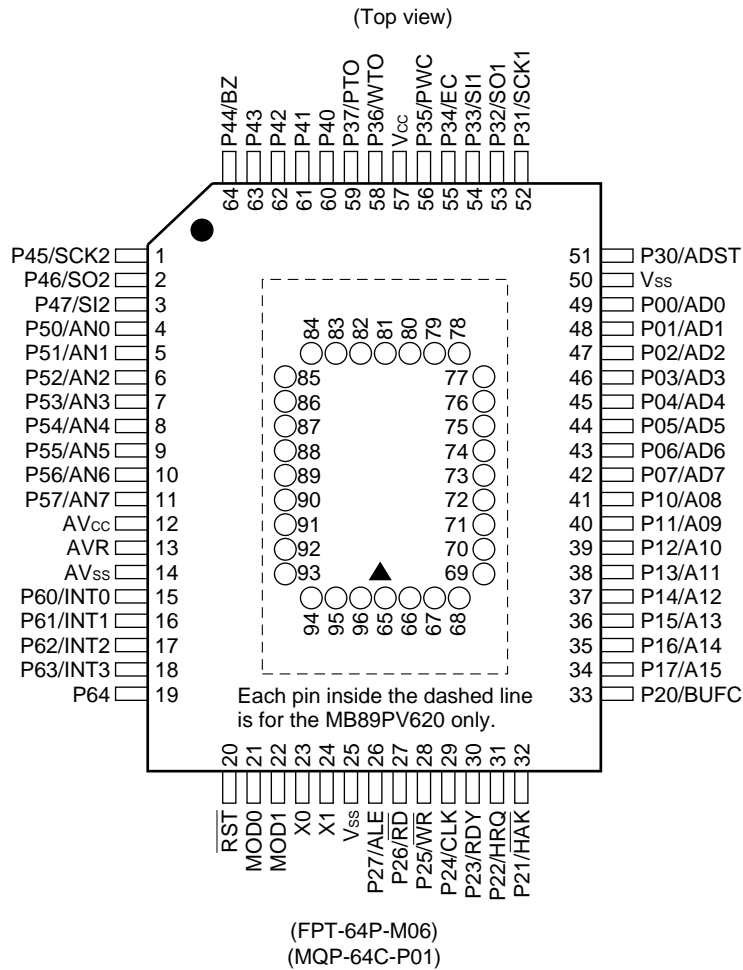

• Pin assignment on package top (MB89PV620 only)

Pin no.	Pin name	Pin no.	Pin name	Pin no.	Pin name	Pin no.	Pin name
65	N.C.	73	A2	81	N.C.	89	$\overline{OE}$
66	V <sub>PP</sub>	74	A1	82	O4	90	N.C.
67	A12	75	A0	83	O5	91	A11
68	A7	76	N.C.	84	O6	92	A9
69	A6	77	O1	85	O7	93	A8
70	A5	78	O2	86	O8	94	A13
71	A4	79	O3	87	$\overline{CE}$	95	A14
72	A3	80	V <sub>ss</sub>	88	A10	96	V <sub>cc</sub>

N.C.: Internally connected. Do not use.

# MB89620 Series

## ■ PIN DESCRIPTION

Pin no.			Pin name	Circuit type	Function
SH-DIP <sup>*1</sup> MDIP <sup>*2</sup>	QFP1 <sup>*3</sup> MQFP <sup>*4</sup>	SQFP <sup>*5</sup> QFP2 <sup>*6</sup>			
30	23	22	X0	A	Crystal oscillator pins
31	24	23	X1		
28	21	20	MOD0	B	Operating mode selection pins Connect directly to V <sub>CC</sub> or V <sub>SS</sub> .
29	22	21	MOD1		
27	20	19	$\overline{\text{RST}}$	C	Reset I/O pin This pin is an N-ch open-drain output type with a pull-up resistor, and a hysteresis input type. "L" is output from this pin by an internal reset source. The internal circuit is initialized by the input of "L".
56 to 49	49 to 42	48 to 41	P00/AD0 to P07/AD7	D	General-purpose I/O ports When an external bus is used, these ports function as multiplex pins of lower address output and data I/O.
48 to 41	41 to 34	40 to 33	P10/A08 to P17/A15	D	General-purpose I/O ports When an external bus is used, these ports function as upper address output.
40	33	32	P20/BUFC	F	General-purpose output-only port When an external bus is used, this port can also be used as a buffer control output by setting the BCTR.
39	32	31	P21/ $\overline{\text{HAK}}$	F	General-purpose output-only port When an external bus is used, this port can also be used as a hold acknowledge output by setting the BCTR.
38	31	30	P22/HRQ	D	General-purpose output-only port When an external bus is used, this port can also be used as a hold request input by setting the BCTR.
37	30	29	P23/RDY	D	General-purpose output-only port When an external bus is used, this port functions as a ready input.
36	29	28	P24/CLK	F	General-purpose output-only port When an external bus is used, this port functions as a clock output.
35	28	27	P25/ $\overline{\text{WR}}$	F	General-purpose output-only port When an external bus is used, this port functions as a write signal output.
34	27	26	P26/ $\overline{\text{RD}}$	F	General-purpose output-only port When an external bus is used, this port functions as a read signal output.
33	26	25	P27/ALE	F	General-purpose output-only port When an external bus is used, this port functions as an address latch signal output.

(Continued)

\*1: DIP-64P-M01, DIP-64C-A06

\*2: MDP-64C-P02

\*3: FPT-64P-M06

\*4: MQP-64C-P01

\*5: FPT-64P-M03

\*6: FPT-64P-M09



# MB89620 Series

(Continued)

Pin no.			Pin name	Circuit type	Function
SH-DIP*1 MDIP*2	QFP1*3 MQFP*4	SQFP*5 QFP2*6			
58	51	50	P30/ADST	E	General-purpose I/O port Also serves as an A/D converter external activation. This port is a hysteresis input type.
59	52	51	P31/SCK1	E	General-purpose I/O port Also serves as the clock I/O for the 8-bit serial I/O 1. This port is a hysteresis input type.
60	53	52	P32/SO1	E	General-purpose I/O port Also serves as the data output for the 8-bit serial I/O 1. This port is a hysteresis input type.
61	54	53	P33/SI1	E	General-purpose I/O port Also serves as the data input for the 8-bit serial I/O 1. This port is a hysteresis input type.
62	55	54	P34/EC	E	General-purpose I/O port Also serves as the external clock input for the 16-bit timer/counter. This port is a hysteresis input type.
63	56	55	P35/PWC	E	General-purpose I/O port Also serves as the measured pulse input for the 8-bit pulse width count timer. This port is a hysteresis input type.
1	58	57	P36/WTO	E	General-purpose I/O port Also serves as the toggle output for the 8-bit pulse width count timer. This port is a hysteresis input type.
2	59	58	P37/PTO	E	General-purpose I/O port Also serves as the toggle output for the 8-bit PWM timer. This port is a hysteresis input type.
3 to 6	60 to 63	59 to 62	P40 to P43	G	N-ch open-drain I/O ports These ports are a hysteresis input type.
7	64	63	P40/BZ	G	N-ch open-drain I/O port Also serves as a buzzer output. This port is a hysteresis input type.
8	1	64	P45/SCK2	G	N-ch open-drain I/O port Also serves as the clock I/O for the 8-bit serial I/O 2. This port is a hysteresis input type.
9	2	1	P46/SO2	G	N-ch open-drain I/O port Also serves as the data output for the 8-bit serial I/O 2. This port is a hysteresis input type.
10	3	2	P47/SI2	G	N-ch open-drain I/O port Also serves as the data input for the 8-bit serial I/O 2. This port is a hysteresis input type.

(Continued)

\*1: DIP-64P-M01, DIP-64C-A06

\*2: MDP-64C-P02

\*3: FPT-64P-M06

\*4: MQP-64C-P01

\*5: FPT-64P-M03

\*6: FPT-64P-M09

# MB89620 Series

(Continued)

Pin no.			Pin name	Circuit type	Function
SH-DIP <sup>*1</sup> MDIP <sup>*2</sup>	QFP1 <sup>*3</sup> MQFP <sup>*4</sup>	SQFP <sup>*5</sup> QFP2 <sup>*6</sup>			
11 to 18	4 to 11	3 to 10	P50/AN0 to P57/AN7	H	N-ch open-drain output-only ports Also serve as the analog input for the A/D converter.
22 to 25	15 to 18	14 to 17	P60/INT0 to P63/INT3	I	General-purpose input-only ports Also serve as an external interrupt input. These ports are a hysteresis input type.
26	19	18	P64	I	General-purpose input-only port This port is a hysteresis input type.
64	57	56	V <sub>CC</sub>	—	Power supply pin
32, 57	25, 50	24, 49	V <sub>SS</sub>	—	Power supply (GND) pins
19	12	11	AV <sub>CC</sub>	—	A/D converter power supply pin
20	13	12	AVR	—	A/D converter reference voltage input pin
21	14	13	AV <sub>SS</sub>	—	A/D converter power supply (GND) pin Use this pin at the same voltage as V <sub>SS</sub> .

\*1: DIP-64P-M01, DIP-64C-A06

\*2: MDP-64C-P02

\*3: FPT-64P-M06

\*4: MQP-64C-P01

\*5: FPT-64P-M03

\*6: FPT-64P-M09

# MB89620 Series

• External EPROM pins (MB89PV620 only)



Pin no.		Pin name	I/O	Function
MDIP <sup>*1</sup>	MQFP <sup>*2</sup>			
65	66	V <sub>PP</sub>	O	"H" level output pin
66	67	A12	O	Address output pins
67	68	A7		
68	69	A6		
69	70	A5		
70	71	A4		
71	72	A3		
72	73	A2		
73	74	A1		
74	75	A0		
75	77	O1	I	Data input pins
76	78	O2		
77	79	O3		
78	80	V <sub>SS</sub>	O	Power supply (GND) pin
79	82	O4	I	Data input pins
80	83	O5		
81	84	O6		
82	85	O7		
83	86	O8		
84	87	$\overline{CE}$	O	ROM chip enable pin Outputs "H" during standby.
85	88	A10	O	Address output pin
86	89	$\overline{OE}$	O	ROM output enable pin Outputs "L" at all times.
87	91	A11	O	Address output pins
88	92	A9		
89	93	A8		
90	94	A13		
91	95	A14	O	
92	96	V <sub>CC</sub>	O	EPROM power supply pin
—	65 76 81 90	N.C.	—	Internally connected pins Be sure to leave them open.

\*1: MDP-64C-P02

\*2: MQP-64C-P01

# MB89620 Series

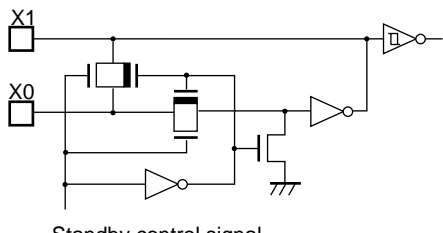
## ■ I/O CIRCUIT TYPE

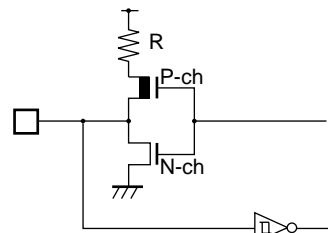
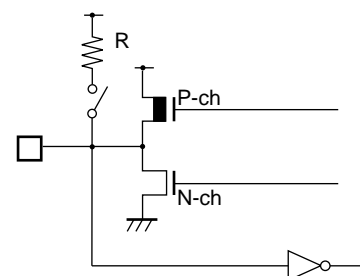
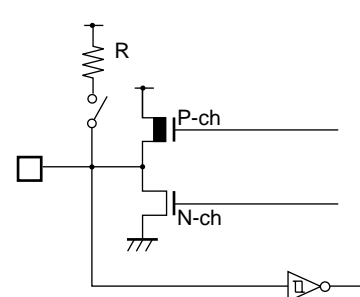
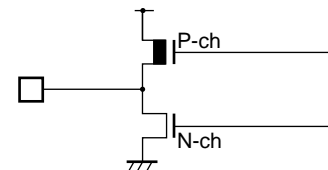
Type	Circuit	Remarks
A	 <p>Standby control signal</p>	<ul style="list-style-type: none"> <li>• At an oscillation feedback resistor of approximately 1 MΩ/5.0 V</li> </ul>
B		
C		<ul style="list-style-type: none"> <li>• At an output pull-up resistor (P-ch) of approximately 50 kΩ/5.0 V</li> </ul>
D		<ul style="list-style-type: none"> <li>• CMOS output</li> <li>• CMOS input</li> <li>• Pull-up resistor optional (except P22 and P23)</li> </ul>
E		<ul style="list-style-type: none"> <li>• CMOS output</li> <li>• Hysteresis input</li> <li>• Pull-up resistor optional</li> </ul>
F		<ul style="list-style-type: none"> <li>• CMOS output</li> </ul>

(Continued)

(Continued)

Type	Circuit	Remarks
G		<ul style="list-style-type: none"> <li>• N-ch open-drain output</li> <li>• Hysteresis input</li> <li>• Pull-up resistor optional (MB89623, MB89625, MB89626, and MB89627 only)</li> </ul>
H		<ul style="list-style-type: none"> <li>• N-ch open-drain output</li> <li>• Analog input</li> <li>• Pull-up resistor optional</li> </ul>
I		<ul style="list-style-type: none"> <li>• Hysteresis input</li> <li>• Pull-up resistor optional</li> </ul>

## ■ HANDLING DEVICES

### 1. Preventing Latchup

Latchup may occur on CMOS ICs if voltage higher than  $V_{CC}$  or lower than  $V_{SS}$  is applied to input and output pins other than medium- to high-voltage pins or if higher than the voltage which shows on “1. Absolute Maximum Ratings” in section “■ Electrical Characteristics” is applied between  $V_{CC}$  and  $V_{SS}$ .

When latchup occurs, power supply current increases rapidly and might thermally damage elements. When using, take great care not to exceed the absolute maximum ratings.

Also, take care to prevent the analog power supply ( $AV_{CC}$  and  $AVR$ ) and analog input from exceeding the digital power supply ( $V_{CC}$ ) when the analog system power supply is turned on and off.

### 2. Treatment of Unused Input Pins

Leaving unused input pins open could cause malfunctions. They should be connected to a pull-up or pull-down resistor.

### 3. Treatment of Power Supply Pins on Microcontrollers with A/D Converters

Connect to be  $AV_{CC} = DAVC = V_{CC}$  and  $AV_{SS} = AVR = V_{SS}$  even if the A/D converters are not in use.

### 4. Treatment of N.C. Pins

Be sure to leave (internally connected) N.C. pins open.

### 5. Power Supply Voltage Fluctuations

Although  $V_{CC}$  power supply voltage is assured to operate within the rated range, a rapid fluctuation of the voltage could cause malfunctions, even if it occurs within the rated range. Stabilizing voltage supplied to the IC is therefore important. As stabilization guidelines, it is recommended to control power so that  $V_{CC}$  ripple fluctuations (P-P value) will be less than 10% of the standard  $V_{CC}$  value at the commercial frequency (50 to 60 Hz) and the transient fluctuation rate will be less than 0.1 V/ms at the time of a momentary fluctuation such as when power is switched.

### 6. Precautions when Using an External Clock

Even when an external clock is used, oscillation stabilization time is required for power-on reset (optional) and wake-up from stop mode.

## ■ PROGRAMMING TO THE EPROM ON THE MB89P625

The MB89P625 is an OTPROM version of the MB89620 series.

### 1. Features

- 16-Kbyte PROM on chip
- Options can be set using the EPROM programmer.
- Equivalency to the MBM27C256A in EPROM mode (when programmed with the EPROM programmer)

### 2. Memory Space

Memory space in each mode such as 16-Kbyte PROM, option area is diagrammed below.

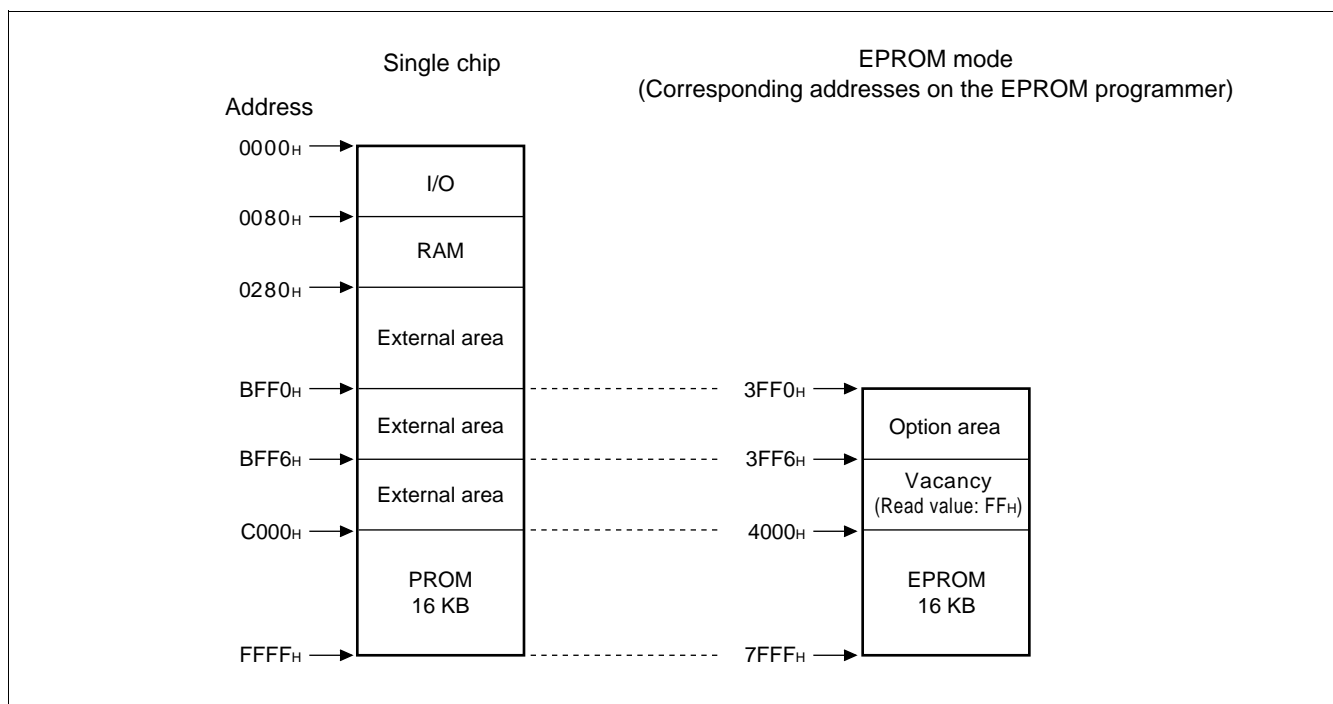

### 3. Programming to the EPROM

In EPROM mode, the MB89P625 functions equivalent to the MBM27C256A. This allows the PROM to be programmed with a general-purpose EPROM programmer (the electronic signature mode cannot be used) by using the dedicated socket adapter.

When the operating ROM area for a single chip is 16 Kbytes (C000H to FFFFH) the PROM can be programmed as follows:

#### • Programming procedure

- (1) Set the EPROM programmer to the MBM27C256A.
- (2) Load program data into the EPROM programmer at 4000H to 7FFFH (note that addresses C000H to FFFFH while operating as a single chip assign to 4000H to 7FFFH in EPROM mode).  
Load option data into addresses 3FF0H to 3FF6H of the EPROM programmer. (For information about each corresponding option, see "4. Setting OTPROM Options.")
- (3) Program to 3FF0H to 7FFFH with the EPROM programmer.

# MB89620 Series

## 4. Setting OTPROM Options

The programming procedure is the same as that for the PROM. Options can be set by programming values at the addresses shown on the memory map.

The relationship between bits and options is shown on the following bit map:

• **OTPROM option bit map (MB89P625)**

	Bit 7	Bit 6	Bit 5	Bit 4	Bit 3	Bit 2	Bit 1	Bit 0
3FF0 <sub>H</sub>	Vacancy Readable and writable	Vacancy Readable and writable	Vacancy Readable and writable	Vacancy Readable and writable	Vacancy Readable and writable	Reset pin output 1: Yes 0: No	Oscillation stabilization time 1: Crystal 0: Ceramic	Power-on reset 1: Yes 0: No
3FF1 <sub>H</sub>	P07 Pull-up 1: No 0: Yes	P06 Pull-up 1: No 0: Yes	P05 Pull-up 1: No 0: Yes	P04 Pull-up 1: No 0: Yes	P03 Pull-up 1: No 0: Yes	P02 Pull-up 1: No 0: Yes	P01 Pull-up 1: No 0: Yes	P00 Pull-up 1: No 0: Yes
3FF2 <sub>H</sub>	P17 Pull-up 1: No 0: Yes	P16 Pull-up 1: No 0: Yes	P15 Pull-up 1: No 0: Yes	P14 Pull-up 1: No 0: Yes	P13 Pull-up 1: No 0: Yes	P12 Pull-up 1: No 0: Yes	P11 Pull-up 1: No 0: Yes	P10 Pull-up 1: No 0: Yes
3FF3 <sub>H</sub>	P37 Pull-up 1: No 0: Yes	P36 Pull-up 1: No 0: Yes	P35 Pull-up 1: No 0: Yes	P34 Pull-up 1: No 0: Yes	P33 Pull-up 1: No 0: Yes	P32 Pull-up 1: No 0: Yes	P31 Pull-up 1: No 0: Yes	P30 Pull-up 1: No 0: Yes
3FF4 <sub>H</sub>	P57 Pull-up 1: No 0: Yes	P56 Pull-up 1: No 0: Yes	P55 Pull-up 1: No 0: Yes	P54 Pull-up 1: No 0: Yes	P53 Pull-up 1: No 0: Yes	P52 Pull-up 1: No 0: Yes	P51 Pull-up 1: No 0: Yes	P50 Pull-up 1: No 0: Yes
3FF5 <sub>H</sub>	Vacancy Readable and writable	Vacancy Readable and writable	Vacancy Readable and writable	P64 Pull-up 1: No 0: Yes	P63 Pull-up 1: No 0: Yes	P62 Pull-up 1: No 0: Yes	P61 Pull-up 1: No 0: Yes	P60 Pull-up 1: No 0: Yes

Notes: • Set each bit to 1 to erase.

• Do not write 0 to the vacant bit.

The read value of the vacant bit is 1, unless 0 is written to it.



## ■ PROGRAMMING TO THE EPROM ON THE MB89P627

The MB89P627 is an OTPROM version of the MB89620 series.

### 1. Features

- 32-Kbyte PROM on chip
- Options can be set using the EPROM programmer.
- Equivalency to the MBM27C256A in EPROM mode (when programmed with the EPROM programmer)

### 2. Memory Space

Memory space in each mode such as 32-Kbyte PROM, option area is diagrammed below.

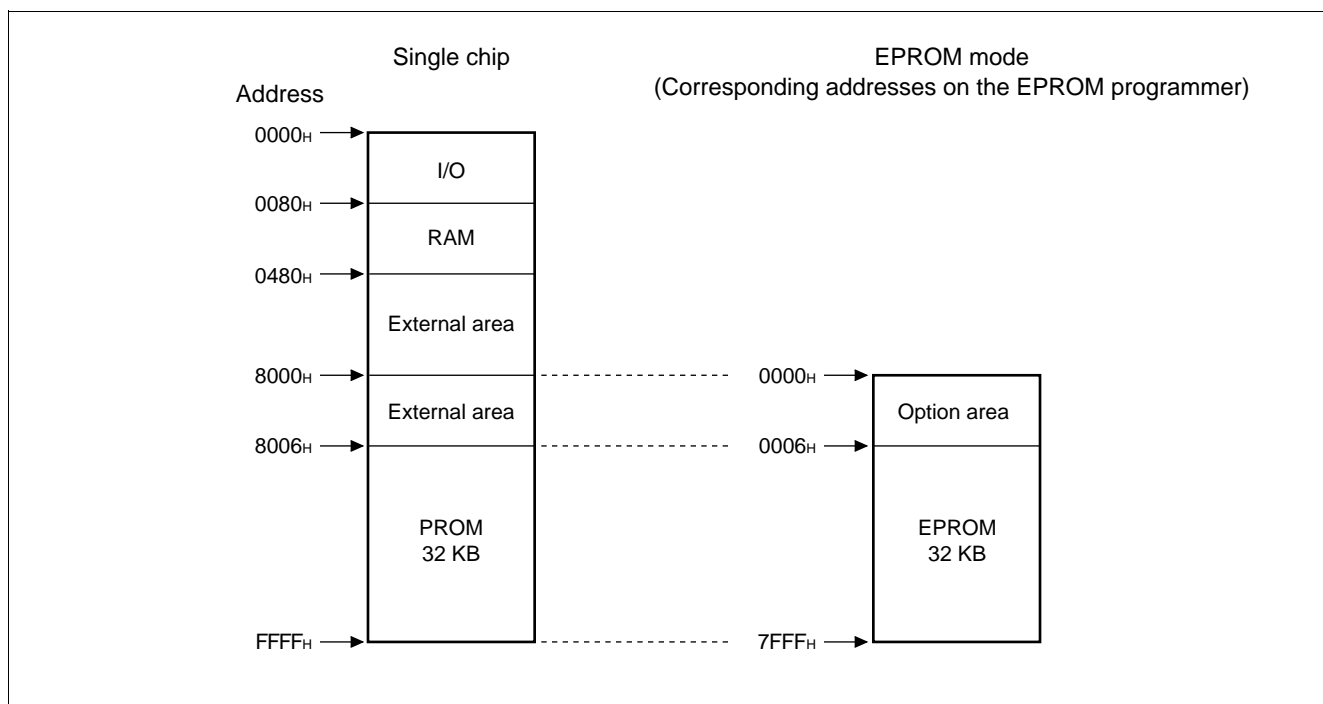

### 3. Programming to the EPROM

In EPROM mode, the MB89P627 functions equivalent to the MBM27C256A. This allows the PROM to be programmed with a general-purpose EPROM programmer (the electronic signature mode cannot be used) by using the dedicated socket adapter.

When the operating ROM area for a single chip is 32 Kbytes (8006<sub>H</sub> to FFFF<sub>H</sub>) the PROM can be programmed as follows:

#### • Programming procedure

- (1) Set the EPROM programmer to the MBM27C256A.
- (2) Load program data into the EPROM programmer at 0006<sub>H</sub> to 7FFF<sub>H</sub> (note that addresses 8006<sub>H</sub> to FFFF<sub>H</sub> while operating as a single chip assign to 0006<sub>H</sub> to 7FFF<sub>H</sub> in EPROM mode).  
Load option data into addresses 0000<sub>H</sub> to 0005<sub>H</sub> of the EPROM programmer. (For information about each corresponding option, see "4. Setting OTPROM Options.")
- (3) Program to 0000<sub>H</sub> to 7FFF<sub>H</sub> with the EPROM programmer.

# MB89620 Series

## 4. Setting OTPROM Options

The programming procedure is the same as that for the PROM. Options can be set by programming values at the addresses shown on the memory map.

The relationship between bits and options is shown on the following bit map:

• **OTPROM option bit map (MB89P627)**

	Bit 7	Bit 6	Bit 5	Bit 4	Bit 3	Bit 2	Bit 1	Bit 0
0000 <sub>H</sub>	Vacancy Readable and writable	Vacancy Readable and writable	Vacancy Readable and writable	Vacancy Readable and writable	Vacancy Readable and writable	Reset pin output 1: Yes 0: No	Oscillation stabilization time 1: Crystal 0: Ceramic	Power-on reset 1: Yes 0: No
0001 <sub>H</sub>	P07 Pull-up 1: No 0: Yes	P06 Pull-up 1: No 0: Yes	P05 Pull-up 1: No 0: Yes	P04 Pull-up 1: No 0: Yes	P03 Pull-up 1: No 0: Yes	P02 Pull-up 1: No 0: Yes	P01 Pull-up 1: No 0: Yes	P00 Pull-up 1: No 0: Yes
0002 <sub>H</sub>	P17 Pull-up 1: No 0: Yes	P16 Pull-up 1: No 0: Yes	P15 Pull-up 1: No 0: Yes	P14 Pull-up 1: No 0: Yes	P13 Pull-up 1: No 0: Yes	P12 Pull-up 1: No 0: Yes	P11 Pull-up 1: No 0: Yes	P10 Pull-up 1: No 0: Yes
0003 <sub>H</sub>	P37 Pull-up 1: No 0: Yes	P36 Pull-up 1: No 0: Yes	P35 Pull-up 1: No 0: Yes	P34 Pull-up 1: No 0: Yes	P33 Pull-up 1: No 0: Yes	P32 Pull-up 1: No 0: Yes	P31 Pull-up 1: No 0: Yes	P30 Pull-up 1: No 0: Yes
0004 <sub>H</sub>	P57 Pull-up 1: No 0: Yes	P56 Pull-up 1: No 0: Yes	P55 Pull-up 1: No 0: Yes	P54 Pull-up 1: No 0: Yes	P53 Pull-up 1: No 0: Yes	P52 Pull-up 1: No 0: Yes	P51 Pull-up 1: No 0: Yes	P50 Pull-up 1: No 0: Yes
0005 <sub>H</sub>	Vacancy Readable and writable	Vacancy Readable and writable	Vacancy Readable and writable	P64 Pull-up 1: No 0: Yes	P63 Pull-up 1: No 0: Yes	P62 Pull-up 1: No 0: Yes	P61 Pull-up 1: No 0: Yes	P60 Pull-up 1: No 0: Yes
0006 <sub>H</sub>	Vacancy Readable and writable	Vacancy Readable and writable	Vacancy Readable and writable	Vacancy Readable and writable	Vacancy Readable and writable	Vacancy Readable and writable	Vacancy Readable and writable	Vacancy Readable and writable

Notes: • Set each bit to 1 to erase.

• Do not write 0 to the vacant bit.

The read value of the vacant bit is 1, unless 0 is written to it.

## ■ HANDLING THE MB89P625/P627

### 1. Recommended Screening Conditions

High-temperature aging is recommended as the pre-assembly screening procedure for a product with a blanked OTPROM microcomputer program.

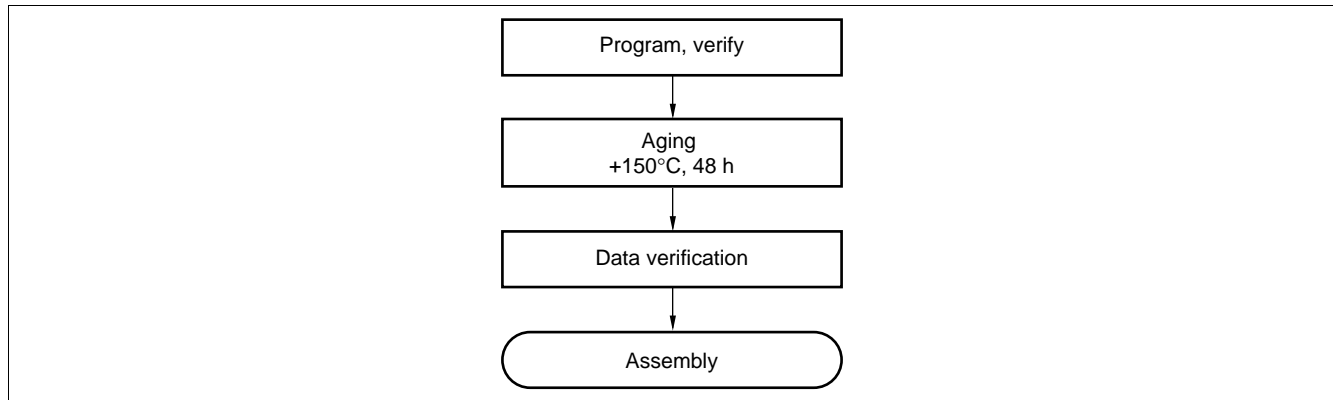

### 2. Programming Yield

All bits cannot be programmed at Fujitsu shipping test to a blanked OTPROM microcomputer, due to its nature. For this reason, a programming yield of 100% cannot be assured at all times.

### 3. Erasure

In order to clear all locations of their programmed contents, it is necessary to expose the internal EPROM to an ultraviolet light source. A dosage of 10 W-seconds/cm<sup>2</sup> is required to completely erase an internal EPROM. This dosage can be obtained by exposure to an ultraviolet lamp (wavelength of 2537 Angstroms (Å)) with intensity of 12000 μW/cm<sup>2</sup> for 15 to 21 minutes. The internal EPROM should be about one inch from the source and all filters should be removed from the UV light source prior to erasure.

It is important to note that the internal EPROM and similar devices, will erase with light sources having wavelengths shorter than 4000Å. Although erasure time will be much longer than with UV source at 2537Å, nevertheless the exposure to fluorescent light and sunlight will eventually erase the internal EPROM, and exposure to them should be prevented to realize maximum system reliability. If used in such an environment, the package windows should be covered by an opaque label or substance.

### 4. EPROM Programmer Socket Adapter and Recommended Programmer Manufacturer

Package	Compatible socket adapter	Recommended programmer manufacturer and programmer name					
		Ando Electric Co., Ltd.	Advantest Corp.		Data I/O Co., Ltd.		
		Sun Hayato Co., Ltd.	AF9706	R4945A	R4945	UNISITE	3900
DIP-64C-M01	ROM-64SD-28DP-8L	Recommended	Recommended	Recommended	Recommended	Recommended	Recommended
FPT-64P-M06	ROM-64QF-28DP-8L	Recommended	Recommended	Recommended	Recommended	Recommended	Recommended
FPT-64P-M09	ROM-64QF2-28DP-8L	—	Recommended	Recommended	Recommended	—	—

Inquiry: Sun Hayato Co., Ltd. : TEL 81-3-3986-0403

Ando Electric Co., Ltd.: TEL 81-3-3733-1160

Advantest Corp. : TEL 81-44-850-0500

Data I/O Co., Ltd.: TEL 81-3-3779-2534

# MB89620 Series

## ■ PROGRAMMING TO THE EPROM PIGGYBACK/EVALUATION DEVICE

### 1. EPROM for Use

MBM27C256A-20TV, MBM27C256A-20CZ

### 2. Programming Socket Adapter

To program to the PROM using an EPROM programmer, use the socket adapter (manufacturer: Sun Hayato Co., Ltd.) listed below.

Package	Adapter socket part number
LCC-32 (Rectangle)	ROM-32LC-28DP-YG
LCC-32 (Square)	ROM-32LC-28DP-2

Inquiry: Sun Hayato Co., Ltd.: TEL 81-3-3802-5760

### 3. Memory Space

Memory space in 32-Kbyte PROM is diagrammed below.

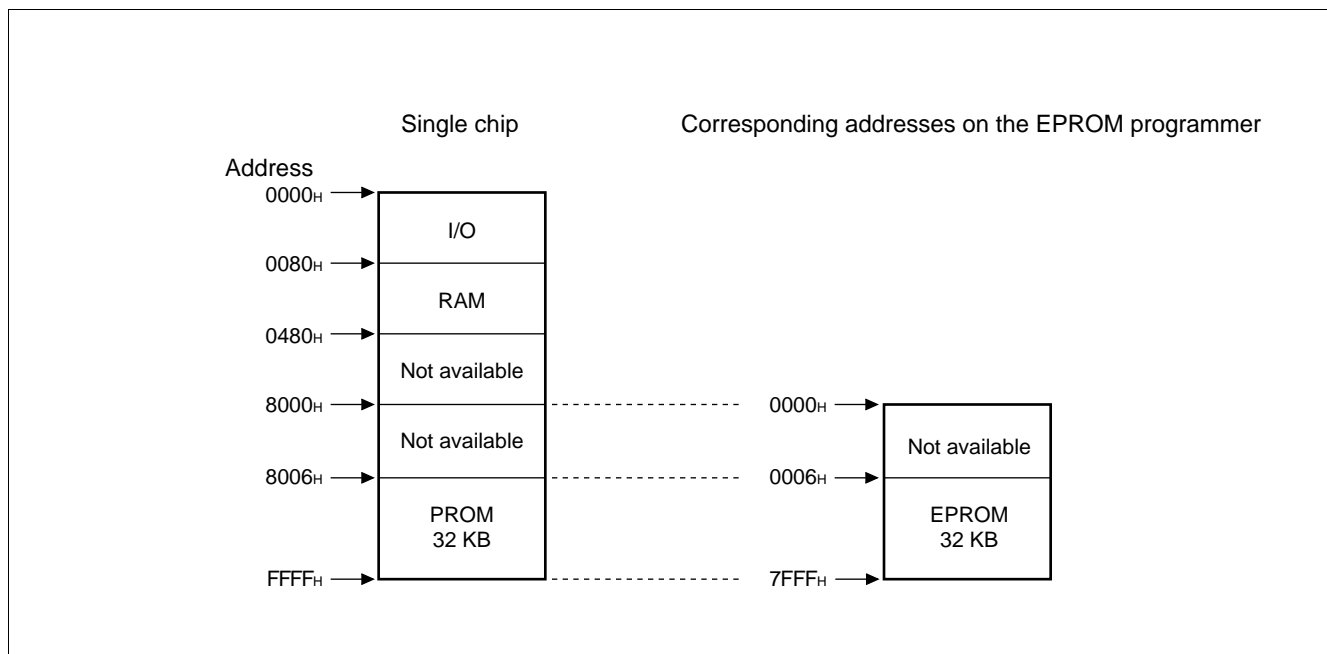

### 4. Programming to the EPROM

- (1) Set the EPROM programmer to the MBM27C256A.
- (2) Load program data into the EPROM programmer at 0006H to 7FFFH.
- (3) Program to 0000H to 7FFFH with the EPROM programmer.

## ■ BLOCK DIAGRAM

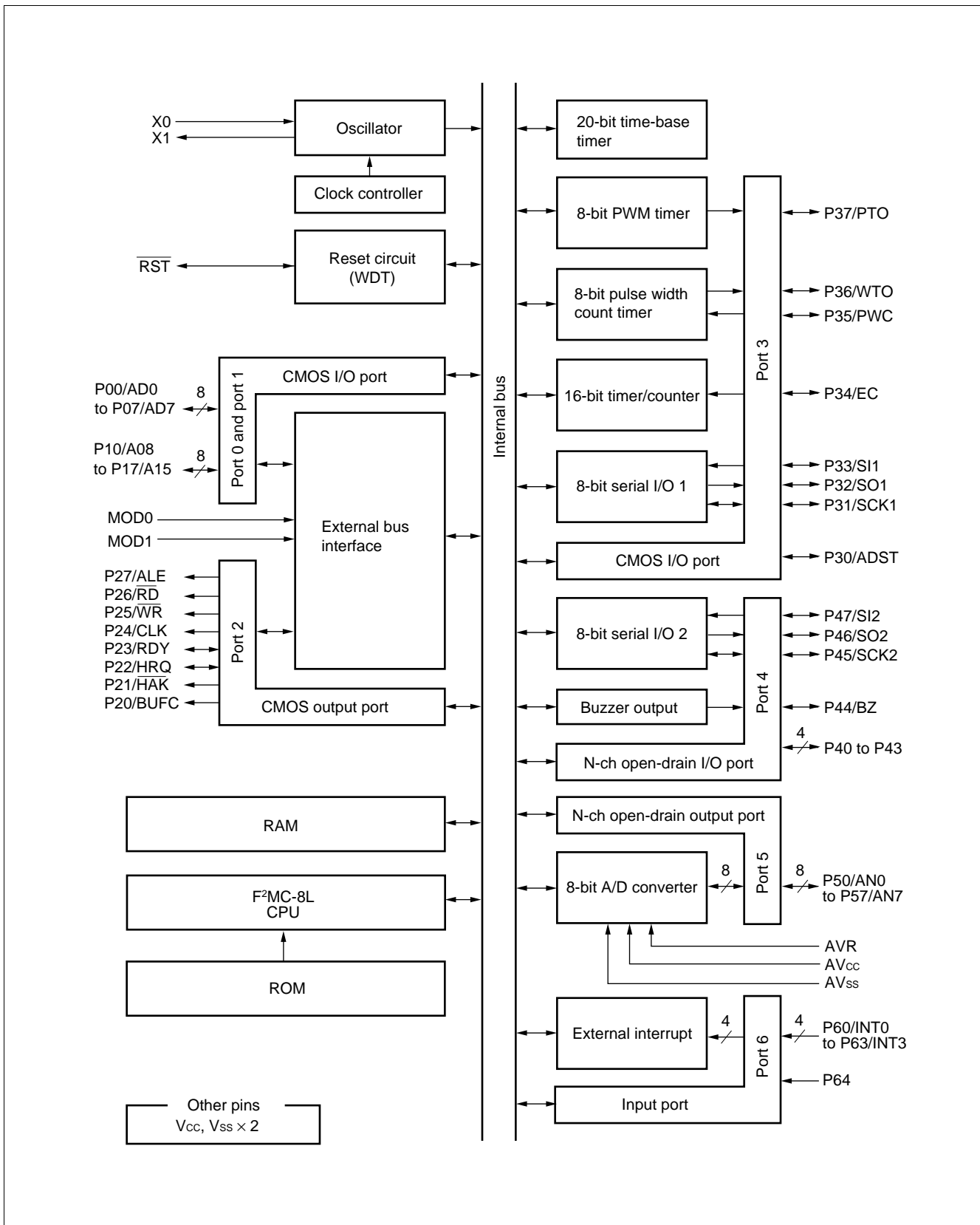

# MB89620 Series

## ■ CPU CORE

### 1. Memory Space

The microcontrollers of the MB89620 series offer a memory space of 64 Kbytes for storing all of I/O, data, and program areas. The I/O area is located at the lowest address. The data area is provided immediately above the I/O area. The data area can be divided into register, stack, and direct areas according to the application. The program area is located at exactly the opposite end, that is, near the highest address. Provide the tables of interrupt reset vectors and vector call instructions toward the highest address within the program area. The memory space of the MB89620 series is structured as illustrated below.

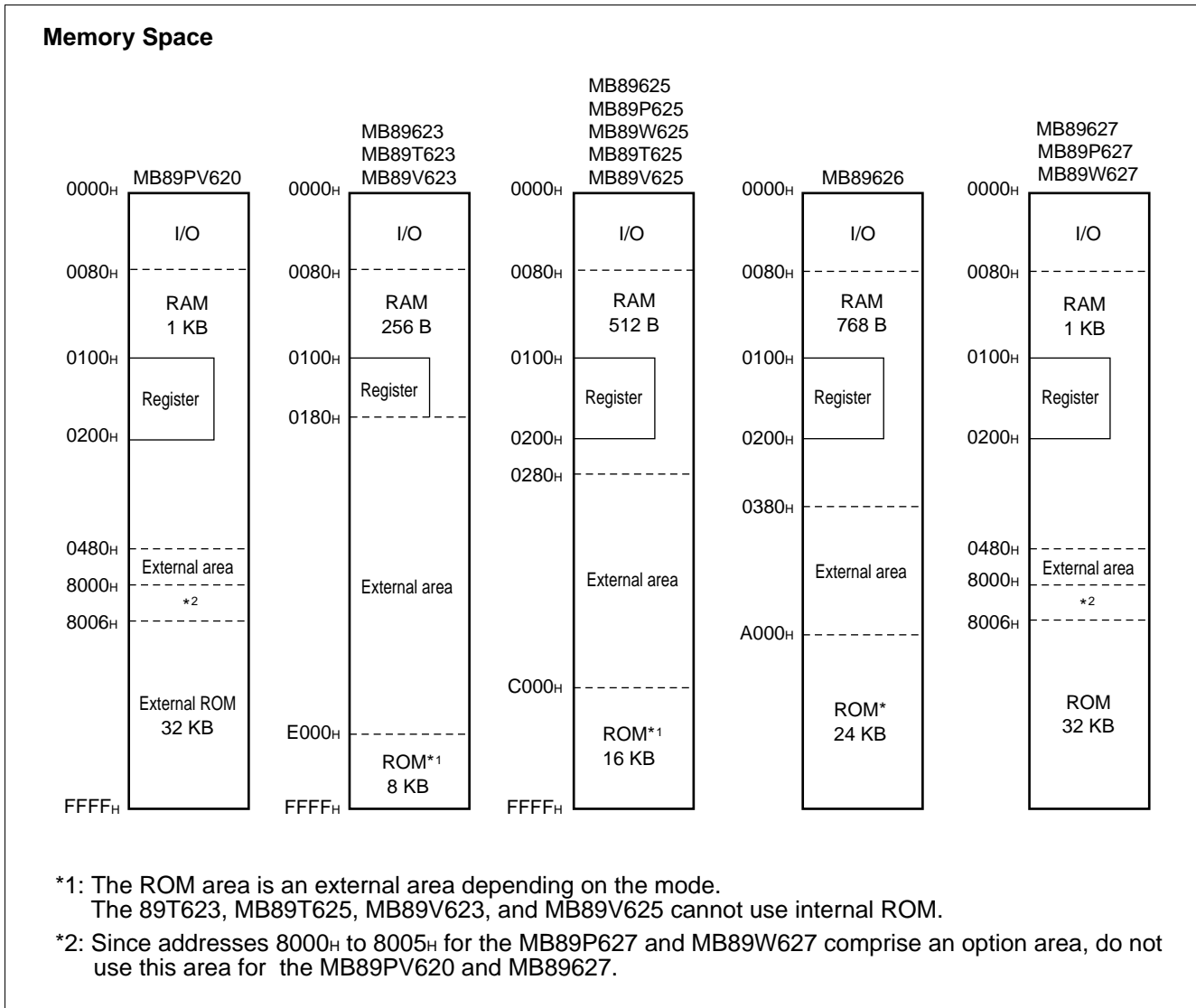

## 2. Registers

The F<sup>2</sup>MC-8L family has two types of registers; dedicated registers in the CPU and general-purpose registers in the memory. The following dedicated registers are provided:

- Program counter (PC): A 16-bit register for indicating instruction storage positions
- Accumulator (A): A 16-bit temporary register for storing arithmetic operations, etc. When the instruction is an 8-bit data processing instruction, the lower byte is used.
- Temporary accumulator (T): A 16-bit register which performs arithmetic operations with the accumulator. When the instruction is an 8-bit data processing instruction, the lower byte is used.
- Index register (IX): A 16-bit register for index modification
- Extra pointer (EP): A 16-bit pointer for indicating a memory address
- Stack pointer (SP): A 16-bit register for indicating a stack area
- Program status (PS): A 16-bit register for storing a register pointer, a condition code

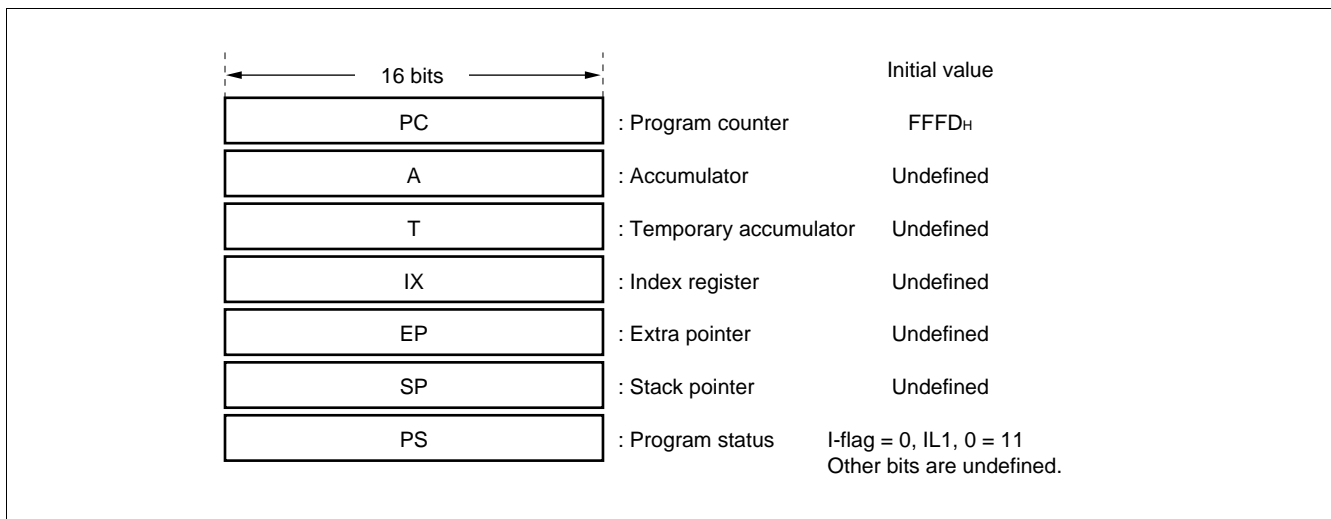

The PS can further be divided into higher 8 bits for use as a register bank pointer (RP) and the lower 8 bits for use as a condition code register (CCR). (See the diagram below.)

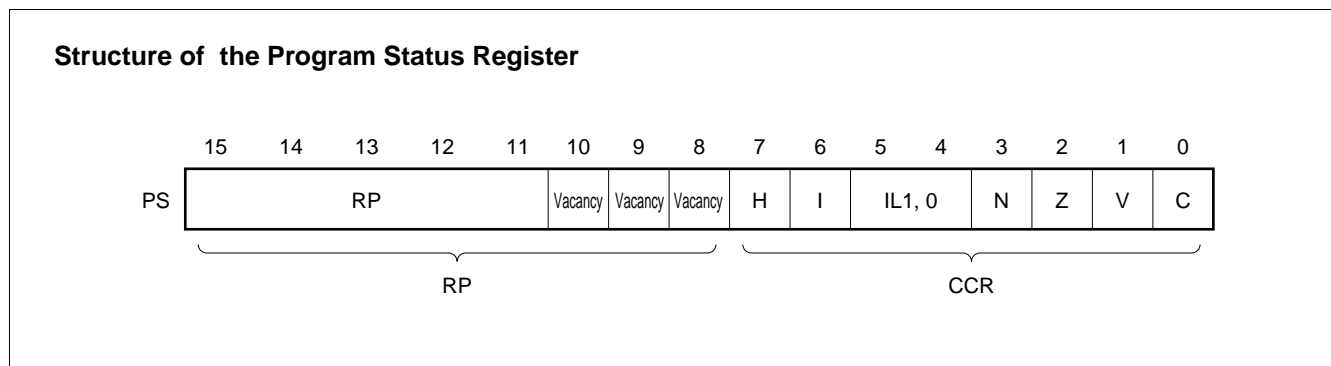

# MB89620 Series

The RP indicates the address of the register bank currently in use. The relationship between the pointer contents and the actual address is based on the conversion rule illustrated below.

## Rule for Conversion of Actual Addresses of the General-purpose Register Area

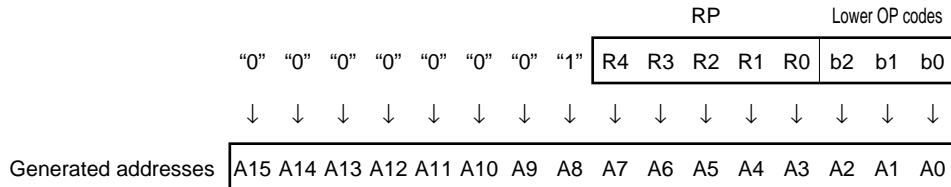

The CCR consists of bits indicating the results of arithmetic operations and the contents of transfer data and bits for control of CPU operations at the time of an interrupt.

**H-flag:** Set when a carry or a borrow from bit 3 to bit 4 occurs as a result of an arithmetic operation. Cleared otherwise. This flag is for decimal adjustment instructions.

**I-flag:** Interrupt is allowed when this flag is set to 1. Interrupt is prohibited when the flag is set to 0. Set to 0 when reset.

**IL1, 0:** Indicates the level of the interrupt currently allowed. Processes an interrupt only if its request level is higher than the value indicated by this bit.

IL1	ILO	Interrupt level	High-low
0	0	1	High ↑ ↓ Low = no interrupt
0	1		
1	0	2	
1	1	3	

**N-flag:** Set if the MSB is set to 1 as the result of an arithmetic operation. Cleared when the bit is set to 0.

**Z-flag:** Set when an arithmetic operation results in 0. Cleared otherwise.

**V-flag:** Set if the complement on 2 overflows as a result of an arithmetic operation. Reset if the overflow does not occur.

**C-flag:** Set when a carry or a borrow from bit 7 occurs as a result of an arithmetic operation. Cleared otherwise. Set to the shift-out value in the case of a shift instruction.



The following general-purpose registers are provided:

General-purpose registers: An 8-bit register for storing data

The general-purpose registers are 8 bits and located in the register banks of the memory. One bank contains eight registers and up to a total of 32 banks can be used on the MB89620. In the MB89623, there are 16 banks in internal RAM. The remaining 16 banks can be extended externally by allocating an external RAM to addresses 0180<sub>H</sub> to 01FF<sub>H</sub> using an external circuit. The bank currently in use is indicated by the register bank pointer (RP).

Note: The number of register banks that can be used varies with the RAM size.

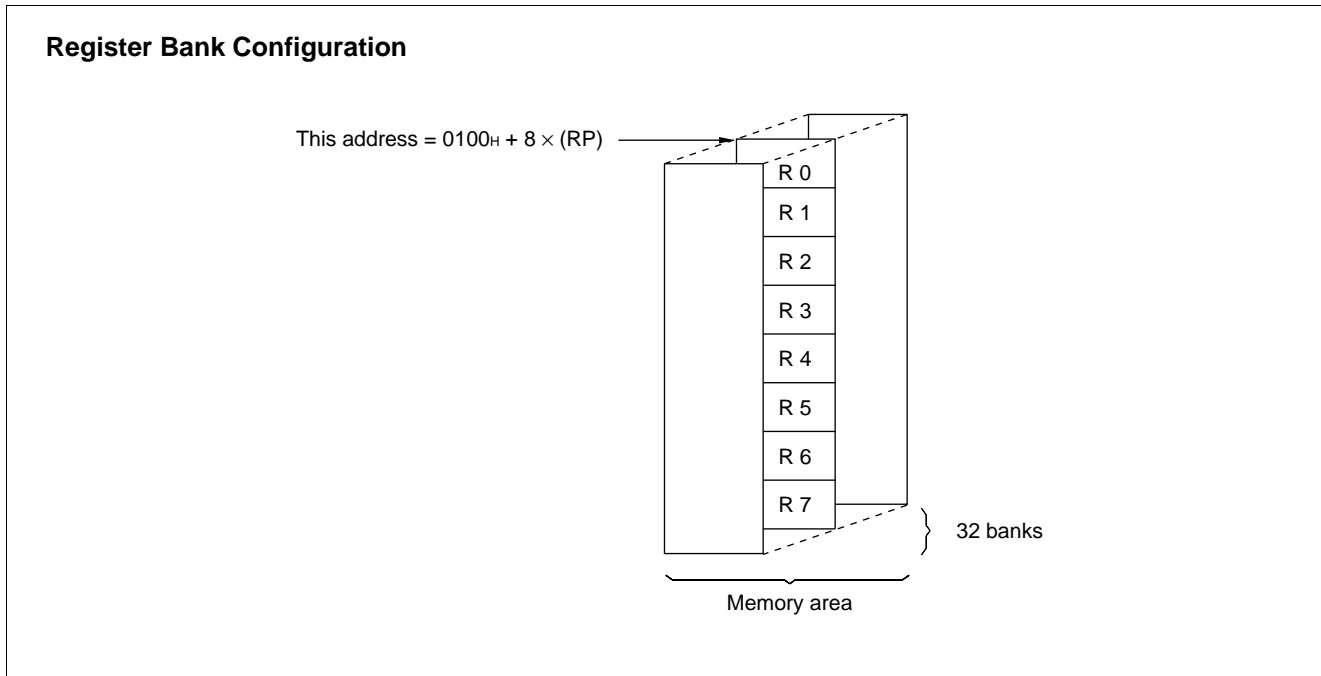

# MB89620 Series

## ■ I/O MAP

Address	Read/write	Register name	Register description
00H	(R/W)	PDR0	Port 0 data register
01H	(W)	DDR0	Port 0 data direction register
02H	(R/W)	PDR1	Port 1 data register
03H	(W)	DDR1	Port 1 data direction register
04H	(R/W)	PDR2	Port 2 data register
05H	(R/W)	BCTR	External bus pin control register
06H			Vacancy
07H			Vacancy
08H	(R/W)	STBC	Standby control register
09H	(R/W)	WDTC	Watchdog timer control register
0AH	(R/W)	TBTC	Time-base timer control register
0BH			Vacancy
0CH	(R/W)	PDR3	Port 3 data register
0DH	(W)	DDR3	Port 3 data direction register
0EH	(R/W)	PDR4	Port 4 data register
0FH	(R/W)	BZCR	Buzzer register
10H	(R/W)	PDR5	Port 5 data register
11H	(R)	PDR6	Port 6 data register
12H	(R/W)	CNTR	PWM control register 1
13H	(W)	COMR	PWM compare register
14H	(R/W)	PCR1	PWC pulse width control register 1
15H	(R/W)	PCR2	PWC pulse width control register 2
16H	(R/W)	RLBR	PWC reload buffer register
17H			Vacancy
18H	(R/W)	TMCR	16-bit timer control register
19H	(R/W)	TCHR	16-bit timer count register (H)
1AH	(R/W)	TCLR	16-bit timer count register (L)
1BH			Vacancy
1CH	(R/W)	SMR1	Serial I/O 1 mode register
1DH	(R/W)	SDR1	Serial I/O 1 data register
1EH	(R/W)	SMR2	Serial I/O 2 mode register
1FH	(R/W)	SDR2	Serial I/O 2 data register

(Continued)

(Continued)

Address	Read/write	Register name	Register description
20 <sub>H</sub>	(R/W)	ADC1	A/D converter control register 1
21 <sub>H</sub>	(R/W)	ADC2	A/D converter control register 2
22 <sub>H</sub>	(R/W)	ADCD	A/D converter data register
23 <sub>H</sub>			Vacancy
24 <sub>H</sub>	(R/W)	EIC1	External interrupt control register 1
25 <sub>H</sub>	(R/W)	EIC2	External interrupt control register 2
26 <sub>H</sub> to 7B <sub>H</sub>			Vacancy
7C <sub>H</sub>	(W)	ILR1	Interrupt level setting register 1
7D <sub>H</sub>	(W)	ILR2	Interrupt level setting register 2
7E <sub>H</sub>	(W)	ILR3	Interrupt level setting register 3
7F <sub>H</sub>			Vacancy

Note: Do not use vacancies.

# MB89620 Series

## ■ ELECTRICAL CHARACTERISTICS

### 1. Absolute Maximum Ratings

( $AV_{SS} = V_{SS} = 0.0\text{ V}$ )

Parameter	Symbol	Value		Unit	Remarks
		Min.	Max.		
Power supply voltage	$V_{CC}$ $AV_{CC}$	$V_{SS} - 0.3$	$V_{SS} + 7.0$	V	*1
A/D converter reference input voltage	AVR	$V_{SS} - 0.3$	$V_{SS} + 7.0$	V	AVR must not exceed $AV_{CC} + 0.3\text{ V}$ .
Input voltage	$V_{I1}$	$V_{SS} - 0.3$	$V_{CC} + 0.3$	V	Except P40 to P47*2
	$V_{I2}$	$V_{SS} - 0.3$	$V_{SS} + 7.0$	V	P40 to P47
Output voltage	$V_O$	$V_{SS} - 0.3$	$V_{CC} + 0.3$	V	Except P40 to P47*2
	$V_{O2}$	$V_{SS} - 0.3$	$V_{SS} + 7.0$	V	P40 to P47
“L” level maximum output current	$I_{OL}$	—	20	mA	
“L” level average output current	$I_{OLAV}$	—	4	mA	Average value (operating current × operating rate)
“L” level total maximum output current	$\Sigma I_{OL}$	—	100	mA	
“L” level total average output current	$\Sigma I_{OLAV}$	—	40	mA	Average value (operating current × operating rate)
“H” level maximum output current	$I_{OH}$	—	-20	mA	
“H” level average output current	$I_{OHAV}$	—	-4	mA	Average value (operating current × operating rate)
“H” level total maximum output current	$\Sigma I_{OH}$	—	-50	mA	
“H” level total average output current	$\Sigma I_{OHAV}$	—	-20	mA	Average value (operating current × operating rate)
Power consumption	$P_D$	—	300	mW	
Operating temperature	$T_A$	-40	+85	°C	
Storage temperature	$T_{stg}$	-55	+150	°C	

\*1: Use  $AV_{CC}$  and  $V_{CC}$  set at the same voltage.

Take care so that  $AV_{CC}$  does not exceed  $V_{CC}$ , such as when power is turned on.

\*2:  $V_{I1}$  and  $V_{O1}$  must not exceed  $V_{CC} + 0.3\text{ V}$ .

**WARNING:** Semiconductor devices can be permanently damaged by application of stress (voltage, current, temperature, etc.) in excess of absolute maximum ratings. Do not exceed these ratings.

## 2. Recommended Operating Conditions

(AV<sub>SS</sub> = V<sub>SS</sub> = 0.0 V)

Parameter	Symbol	Value		Unit	Remarks
		Min.	Max.		
Power supply voltage	V <sub>CC</sub> AV <sub>CC</sub>	2.2*	6.0*	V	Normal operation assurance range* (MB89623/625/626/627)
		2.7*	6.0*	V	Normal operation assurance range* (MB89T623/V623/T625/V625/P625/ W625/P627/W627/PV620)
		1.5	6.0	V	Retains the RAM state in stop mode
A/D converter reference input voltage	AVR	0.0	AV <sub>CC</sub>	V	
Operating temperature	T <sub>A</sub>	-40	+85	°C	

\*: These values vary with the operating frequency and analog assurance range. See Figure 1 and "5. A/D Converter Electrical Characteristics."

**WARNING:** The recommended operating conditions are required in order to ensure the normal operation of the semiconductor device. All of the device's electrical characteristics are warranted when the device is operated within these ranges.

Always use semiconductor devices within their recommended operating condition ranges. Operation outside these ranges may adversely affect reliability and could result in device failure.

No warranty is made with respect to uses, operating conditions, or combinations not represented on the data sheet. Users considering application outside the listed conditions are advised to contact their FUJITSU representatives beforehand.

# MB89620 Series

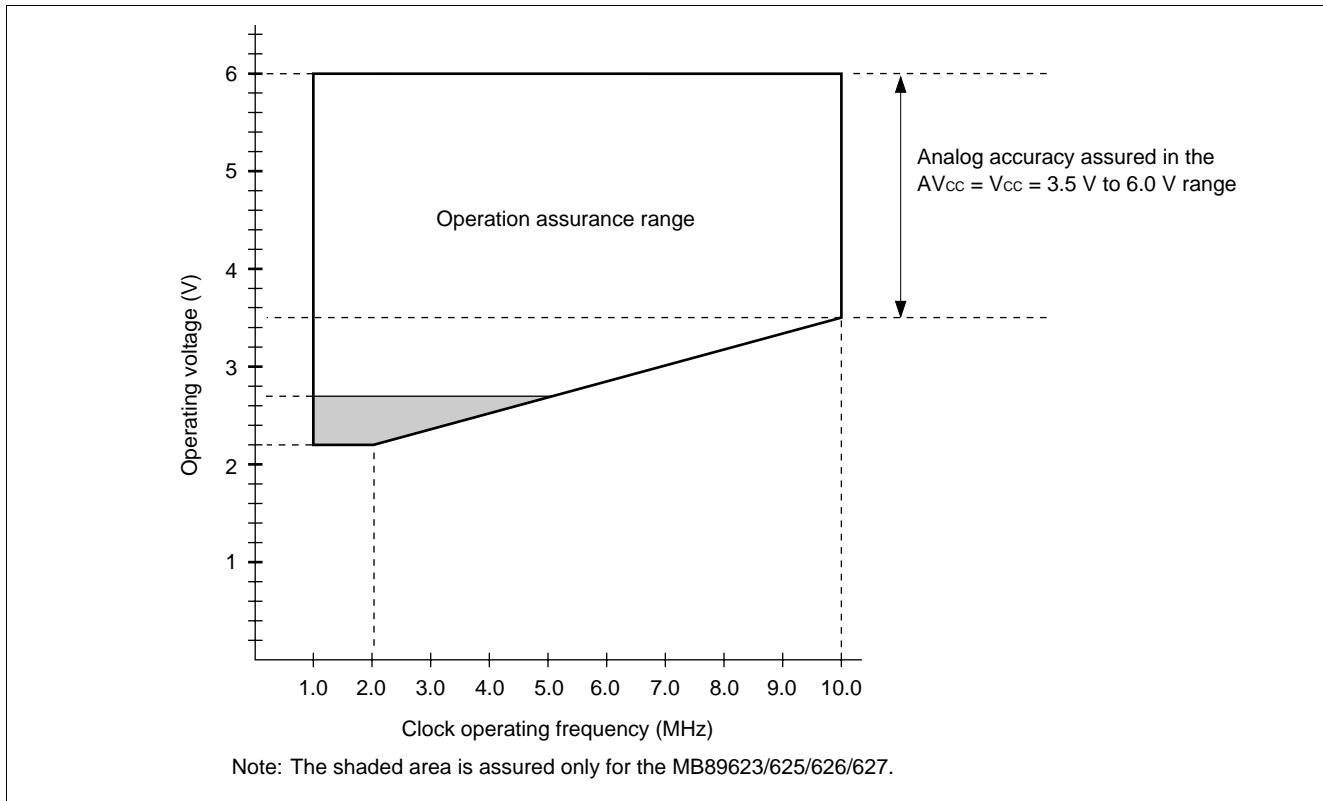

**Figure 1 Operating Voltage vs. Clock Operating Frequency**

Figure 1 indicates the operating frequency of the external oscillator at an instruction cycle of  $4/F_c$ .

# MB89620 Series

## 3. DC Characteristics

( $V_{CC} = V_{CC} = 5.0\text{ V}$ ,  $V_{SS} = V_{SS} = 0.0\text{ V}$ ,  $T_A = -40^\circ\text{C}$  to  $+85^\circ\text{C}$ )

Parameter	Symbol	Pin	Condition	Value			Unit	Remarks
				Min.	Typ.	Max.		
“H” level input voltage	$V_{IH}$	P00 to P07, P10 to P17, P22, P23	—	$0.7 V_{CC}$	—	$V_{CC} + 0.3$	V	
	$V_{IHS}$	$\overline{RST}$ , MOD0, MOD1, P30 to P37, P60 to P64	—	$0.8 V_{CC}$	—	$V_{CC} + 0.3$	V	
	$V_{IHS2}$	P40 to P47	—	$0.8 V_{CC}$	—	$V_{CC} + 0.3$	V	
“L” level input voltage	$V_{IL}$	P00 to P07, P10 to P17, P22, P23	—	$V_{SS} - 0.3$	—	$0.3 V_{CC}$	V	
	$V_{ILS}$	$\overline{RST}$ , MOD0, MOD1, P30 to P37, P40 to P47, P60 to P64	—	$V_{SS} - 0.3$	—	$0.2 V_{CC}$	V	
Open-drain output pin application voltage	$V_D$	P50 to P57	—	$V_{SS} - 0.3$	—	$V_{CC} + 0.3$	V	
	$V_{D2}$	P40 to P47	—	$V_{SS} - 0.3$	—	$V_{SS} + 6.0$	V	
“H” level output voltage	$V_{OH}$	P00 to P07, P10 to P17, P20 to P27, P30 to P37	$I_{OH} = -2.0\text{ mA}$	4.0	—	—	V	
“L” level output voltage	$V_{OL}$	P00 to P07, P10 to P17, P20 to P27, P30 to P37, P40 to P47, P50 to P57	$I_{OL} = +4.0\text{ mA}$	—	—	0.4	V	
	$V_{OL2}$	$\overline{RST}$		—	—	0.4	V	
Input leakage current (Hi-z output leakage current)	$I_{LI1}$	P00 to P07, P10 to P17, P20 to P27, P30 to P37, P40 to P47, P60 to P64, MOD0, MOD1	$0.0\text{ V} < V_i < V_{CC}$	—	—	$\pm 5$	$\mu\text{A}$	Without pull-up resistor
Pull-up resistance	$R_{PULL}$	P00 to P07, P10 to P17, P30 to P37, P40 to P47, P50 to P57, P60 to P64, $\overline{RST}$	$V_i = 0.0\text{ V}$	25	50	100	$\text{k}\Omega$	

(Continued)

# MB89620 Series

(Continued)

( $AV_{CC} = V_{CC} = 5.0\text{ V}$ ,  $AV_{SS} = V_{SS} = 0.0\text{ V}$ ,  $T_A = -40^\circ\text{C}$  to  $+85^\circ\text{C}$ )

Parameter	Symbol	Pin	Condition	Value			Unit	Remarks	
				Min.	Typ.	Max.			
Power supply current <sup>*1</sup>	$I_{CC}$		$F_C = 10\text{ MHz}$ Normal operating mode $t_{inst}^{*2} = 0.4\ \mu\text{s}$	—	9	15	mA	MB89623/625/ 627/V623/ T623/V625/ T625/PV620	
				—	10	18			mA
	$I_{CCS}$	$V_{CC}$	$F_C = 10\text{ MHz}$ Sleep mode $t_{inst}^{*2} = 0.4\ \mu\text{s}$	—	3	4	mA		
	$I_{CCH}$		Stop mode $T_A = +25^\circ\text{C}$	—	—	1			$\mu\text{A}$
	$I_A$		$F_C = 10\text{ MHz}$ , when A/D conversion is activated	—	1	3			
$I_{AH}$	$AV_{CC}$	$F_C = 10\text{ MHz}$ , $T_A = +25^\circ\text{C}$ , when A/D conversion is stopped	—	—	1	$\mu\text{A}$			
Input capacitance	$C_{IN}$	Other than $AV_{CC}$ , $AV_{SS}$ , $V_{CC}$ , and $V_{SS}$	$f = 1\text{ MHz}$	—	10	—	pF		

\*1: In the case of the MB89PV620, the current consumed by the connected EPROM and ICE is not included. The power supply current is measured at the external clock.

\*2: For information on  $t_{inst}$ , see “(4) Instruction Cycle” in “4. AC Characteristics.”



## 4. AC Characteristics

### (1) Reset Timing

( $V_{CC} = +5.0\text{ V} \pm 10\%$ ,  $AV_{SS} = V_{SS} = 0.0\text{ V}$ ,  $T_A = -40^\circ\text{C}$  to  $+85^\circ\text{C}$ )

Parameter	Symbol	Condition	Value		Unit	Remarks
			Min.	Max.		
$\overline{\text{RST}}$ "L" pulse width	$t_{\text{ZLZH}}$	—	16 $t_{\text{CYL}}$	—	ns	

Note:  $t_{\text{CYL}}$  is the oscillation cycle ( $1/F_C$ ) to input to the X0 pin.

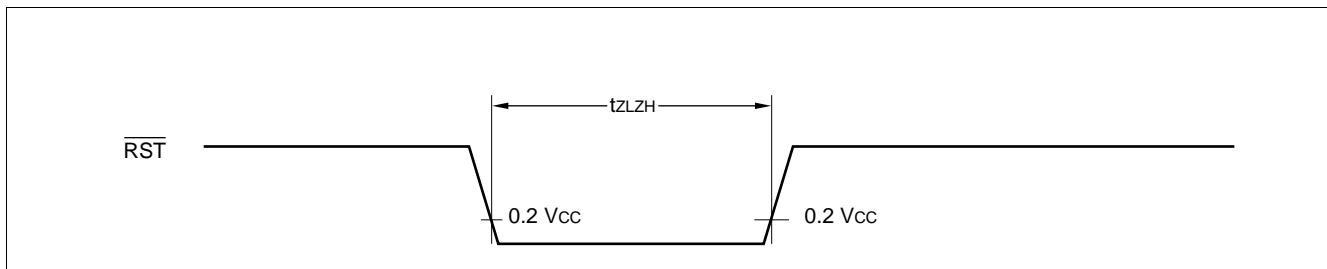

### (2) Power-on Reset

( $AV_{SS} = V_{SS} = 0.0\text{ V}$ ,  $T_A = -40^\circ\text{C}$  to  $+85^\circ\text{C}$ )

Parameter	Symbol	Condition	Value		Unit	Remarks
			Min.	Max.		
Power supply rising time	$t_r$	—	—	50	ms	Power-on reset function only
Power supply cut-off time	$t_{\text{OFF}}$		1	—	ms	Due to repeated operations

Note: Make sure that power supply rises within the selected oscillation stabilization time.

If power supply voltage needs to be varied in the course of operation, a smooth voltage rise is recommended.

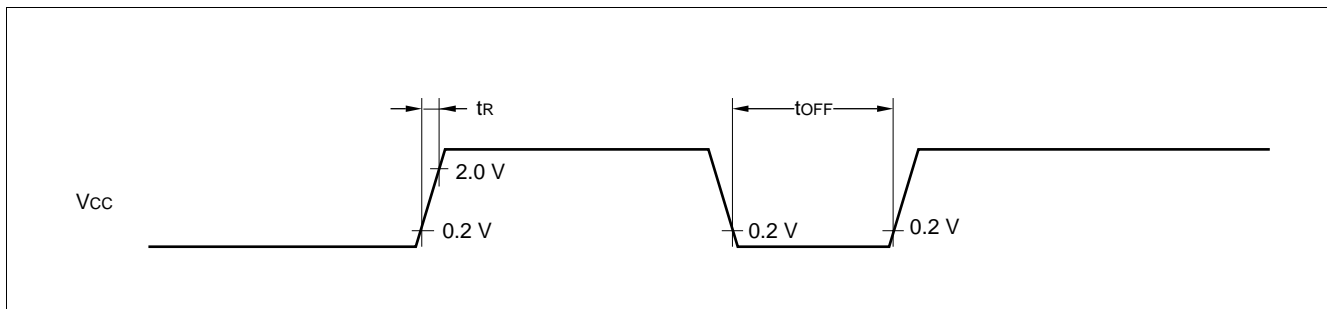

# MB89620 Series

## (3) Clock Timing

( $V_{SS} = V_{SS} = 0.0\text{ V}$ ,  $T_A = -40^\circ\text{C}$  to  $+85^\circ\text{C}$ )

Parameter	Symbol	Pin	Condition	Value		Unit	Remarks
				Min.	Max.		
Clock frequency	$F_c$	X0, X1	—	1	10	MHz	
Clock cycle time	$t_{XYCL}$	X0, X1		100	1000	ns	
Input clock pulse width	$P_{WH}$ $P_{WL}$	X0		20	—	ns	External clock
Input clock rising/falling time	$t_{CR}$ $t_{CF}$	X0		—	10	ns	External clock

### X0 and X1 Timing and Conditions

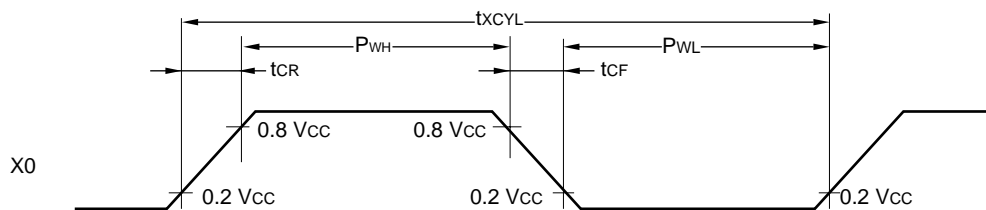

### Clock Conditions

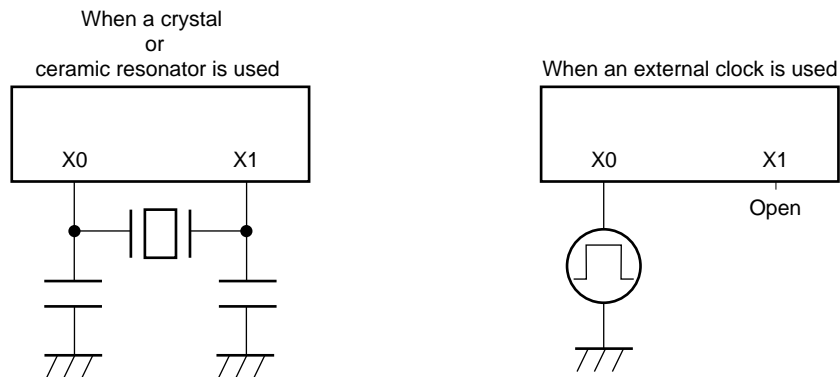

## (4) Instruction Cycle

Parameter	Symbol	Value (typical)	Unit	Remarks
Instruction cycle (minimum execution time)	$t_{inst}$	$4/F_c$	$\mu\text{s}$	$t_{inst} = 0.4\ \mu\text{s}$ when operating at $F_c = 10\ \text{MHz}$

## (5) Recommended Resonator Manufacturers

### Sample Application of Piezoelectric Resonator (FAR Series)

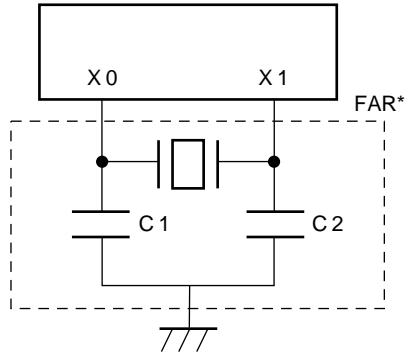

\*: Fujitsu Acoustic Resonator  
 C1 = C2 = 20pF±8 pF (built-in FAR)

FAR part number (built-in capacitor type)	Frequency	Initial deviation of FAR frequency ( $T_A = +25^\circ\text{C}$ )	Temperature characteristics of FAR frequency ( $T_A = -20^\circ\text{C}$ to $+60^\circ\text{C}$ )
FAR-C4CB-08000-M02	8.00 MHz	±0.5%	±0.5%
FAR-C4CB-10000-M02	10.00 MHz	±0.5%	±0.5%

Inquiry: FUJITSU LIMITED

# MB89620 Series

## Sample Application of Ceramic Resonator

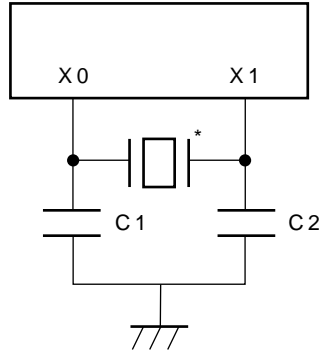

Resonator manufacturer*	Resonator	Frequency	C1 (pF)	C2 (pF)	R (kΩ)
Kyocera Corporation	KBR-7.68MWS	7.68 MHz	33	33	—
	KBR-8.0MWS	8.0 MHz	33	33	—
Murata Mfg. Co., Ltd.	CSA8.00MTZ	8.0 MHz	30	30	—

Inquiry: Kyocera Corporation

- AVX Corporation  
North American Sales Headquarters: TEL 1-803-448-9411
- AVX Limited  
European Sales Headquarters: TEL 44-1252-770000
- AVX/Kyocera H.K. Ltd.  
Asian Sales Headquarters: TEL 852-363-3303
- Murata Mfg. Co., Ltd.  
Murata Electronics North America, Inc.: TEL 1-404-436-1300
- Murata Europe Management GmbH: TEL 49-911-66870
- Murata Electronics Singapore (Pte.) Ltd.: TEL 65-758-4233

## (6) Clock Output Timing

( $V_{CC} = +5.0\text{ V} \pm 10\%$ ,  $AV_{SS} = V_{SS} = 0.0\text{ V}$ ,  $T_A = -40^\circ\text{C}$  to  $+85^\circ\text{C}$ )

Parameter	Symbol	Pin	Condition	Value		Unit	Remarks
				Min.	Max.		
Cycle time	$t_{CYC}$	CLK	—	200	—	ns	$t_{CYCL} \times 2$ at 10 MHz oscillation
CLK $\uparrow \rightarrow$ CLK $\downarrow$	$t_{CHCL}$			30	100	ns	Approx. $t_{CYC}/2$ at 10 MHz oscillation

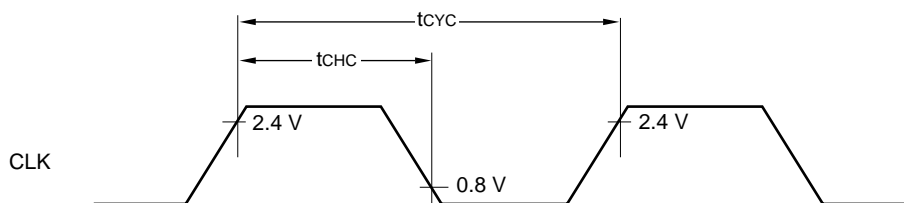

## (7) Bus Read Timing

( $V_{CC} = +5.0 V \pm 10\%$ ,  $F_c = 10 \text{ MHz}$ ,  $A_{VSS} = V_{SS} = 0.0 \text{ V}$ ,  $T_A = -40^\circ\text{C}$  to  $+85^\circ\text{C}$ )

Parameter	Symbol	Pin	Condition	Value		Unit	Remarks
				Min.	Max.		
Valid address $\rightarrow \overline{\text{RD}} \downarrow$ time	$t_{AVRL}$	$\overline{\text{RD}}$ , A15 to A08, AD7 to AD0	—	$1/4 t_{inst}^* - 64 \text{ ns}$	—	$\mu\text{s}$	
$\overline{\text{RD}}$ pulse width	$t_{RLRH}$	RD		$1/2 t_{inst}^* - 20 \text{ ns}$	—	$\mu\text{s}$	
Valid address $\rightarrow$ data read time	$t_{AVDV}$	AD7 to AD0, A15 to A08		—	$1/2 t_{inst}^*$	$\mu\text{s}$	No wait
$\overline{\text{RD}} \downarrow \rightarrow$ data read time	$t_{RLDV}$	$\overline{\text{RD}}$ , AD7 to AD0		—	$1/2 t_{inst}^* - 80 \text{ ns}$	$\mu\text{s}$	No wait
$\overline{\text{RD}} \uparrow \rightarrow$ data hold time	$t_{RHDX}$	AD7 to AD0, $\overline{\text{RD}}$		0	—	$\mu\text{s}$	
$\overline{\text{RD}} \uparrow \rightarrow$ ALE $\uparrow$ time	$t_{RHLH}$	$\overline{\text{RD}}$ , ALE		$1/4 t_{inst}^* - 40 \text{ ns}$	—	$\mu\text{s}$	
$\overline{\text{RD}} \uparrow \rightarrow$ address invalid time	$t_{RHAX}$	$\overline{\text{RD}}$ , A15 to A08		$1/4 t_{inst}^* - 40 \text{ ns}$	—	$\mu\text{s}$	
$\overline{\text{RD}} \downarrow \rightarrow$ CLK $\uparrow$ time	$t_{RLCH}$	$\overline{\text{RD}}$ , CLK		$1/4 t_{inst}^* - 40 \text{ ns}$	—	$\mu\text{s}$	
CLK $\downarrow \rightarrow \overline{\text{RD}} \uparrow$ time	$t_{CLRHL}$			0	—	ns	
$\overline{\text{RD}} \downarrow \rightarrow$ BUFC $\downarrow$ time	$t_{RLBL}$	$\overline{\text{RD}}$ , BUFC		-5	—	$\mu\text{s}$	
BUFC $\uparrow \rightarrow$ valid address time	$t_{BHAV}$	A15 to A08, AD7 to AD0, BUFC	5	—	$\mu\text{s}$		

\*: For information on  $t_{inst}$ , see "(4) Instruction Cycle."

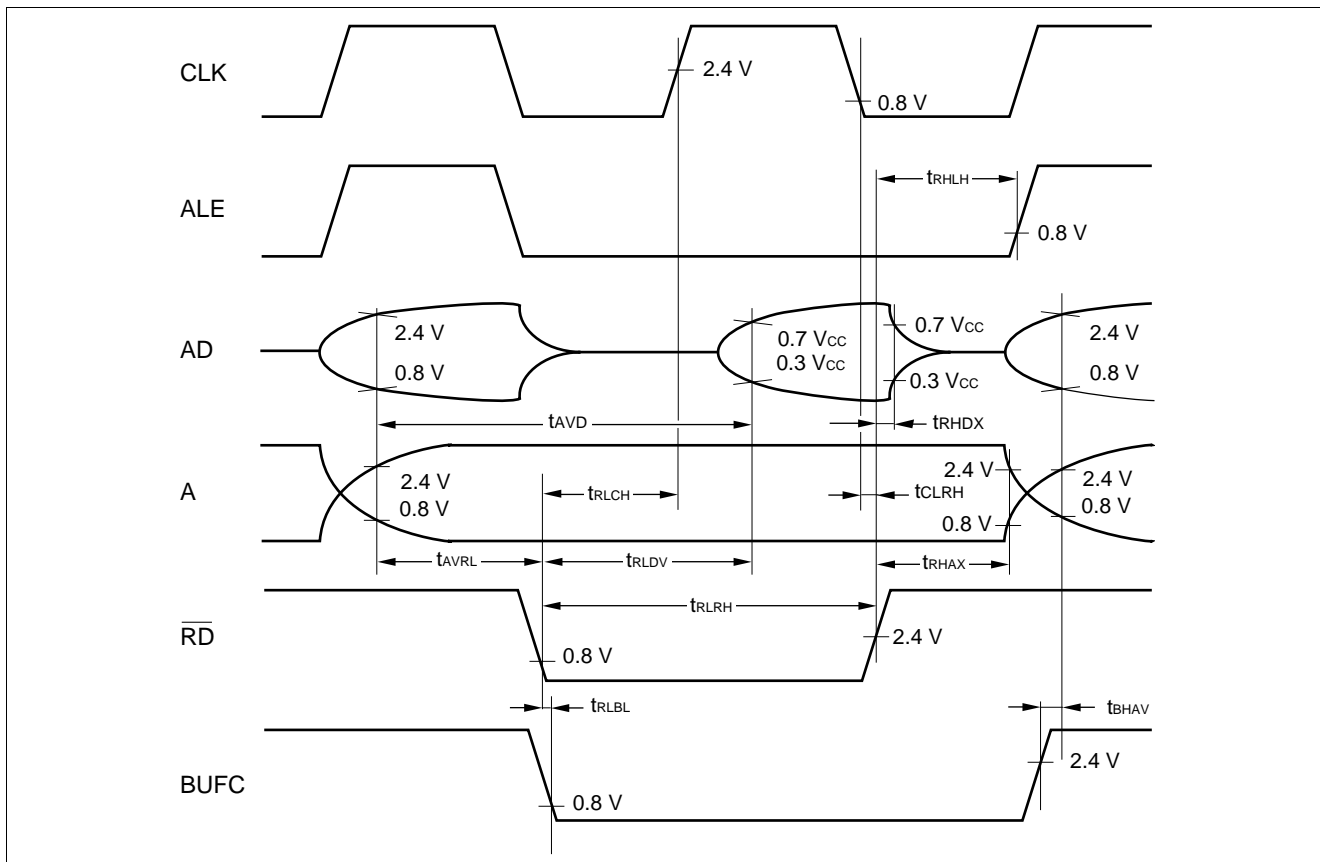

# MB89620 Series

## (8) Bus Write Timing

( $V_{CC} = +5.0 V \pm 10\%$ ,  $F_C = 10 \text{ MHz}$ ,  $V_{SS} = V_{SS} = 0.0 \text{ V}$ ,  $T_A = -40^\circ\text{C}$  to  $+85^\circ\text{C}$ )

Parameter	Symbol	Pin	Condition	Value		Unit	Remarks
				Min.	Max.		
Valid address $\rightarrow$ ALE $\downarrow$ time	$t_{AVLL}$	AD7 to AD0, ALE, A15 to A08	—	$1/4 t_{inst}^{*1} - 64 \text{ ns}$	—	$\mu\text{s}$	
ALE $\downarrow$ time $\rightarrow$ address invalid time	$t_{LLAX}$	AD7 to AD0, ALE, A15 to A08		5	—	ns	
Valid address $\rightarrow$ $\overline{\text{WR}}$ $\downarrow$ time	$t_{AVWL}$	$\overline{\text{WR}}$ , ALE		$1/4 t_{inst}^{*1} - 60 \text{ ns}$	—	$\mu\text{s}$	
$\overline{\text{WR}}$ pulse width	$t_{WLWH}$	$\overline{\text{WR}}$		$1/2 t_{inst}^{*1} - 20 \text{ ns}$	—	$\mu\text{s}$	
Write data $\rightarrow$ $\overline{\text{WR}}$ $\uparrow$ time	$t_{DVWH}$	AD7 to AD0, $\overline{\text{WR}}$		$1/2 t_{inst}^{*1} - 60 \text{ ns}$	—	$\mu\text{s}$	
$\overline{\text{WR}}$ $\uparrow$ $\rightarrow$ address invalid time	$t_{WHAX}$	$\overline{\text{WR}}$ , A15 to A08		$1/4 t_{inst}^{*1} - 40 \text{ ns}$	—	ns	
$\overline{\text{WR}}$ $\uparrow$ $\rightarrow$ data hold time	$t_{WHDX}$	AD7 to AD0, $\overline{\text{WR}}$		$1/4 t_{inst}^{*1} - 40 \text{ ns}$	—	$\mu\text{s}$	
$\overline{\text{WR}}$ $\uparrow$ $\rightarrow$ ALE $\uparrow$ time	$t_{WHLH}$	$\overline{\text{WR}}$ , ALE		$1/4 t_{inst}^{*1} - 40 \text{ ns}$	—	$\mu\text{s}$	
$\overline{\text{WR}}$ $\downarrow$ $\rightarrow$ CLK $\uparrow$ time	$t_{WLCH}$	$\overline{\text{WR}}$ , CLK		$1/4 t_{inst}^{*1} - 40 \text{ ns}$	—	$\mu\text{s}$	
CLK $\downarrow$ $\rightarrow$ $\overline{\text{WR}}$ $\uparrow$ time	$t_{CLWH}$	$\overline{\text{WR}}$ , CLK		0	—	ns	
ALE pulse width	$t_{LHLL}$	ALE		$1/4 t_{inst}^{*1} - 35 \text{ ns}^{*2}$	—	$\mu\text{s}$	
ALE $\downarrow$ $\rightarrow$ CLK $\uparrow$ time	$t_{LLCH}$	ALE, CLK		$1/4 t_{inst}^{*1} - 30 \text{ ns}^{*2}$	—	$\mu\text{s}$	

\*1: For information on  $t_{inst}$ , see “(4) Instruction Cycle.”

\*2: These characteristics are also applicable to the bus read timing.

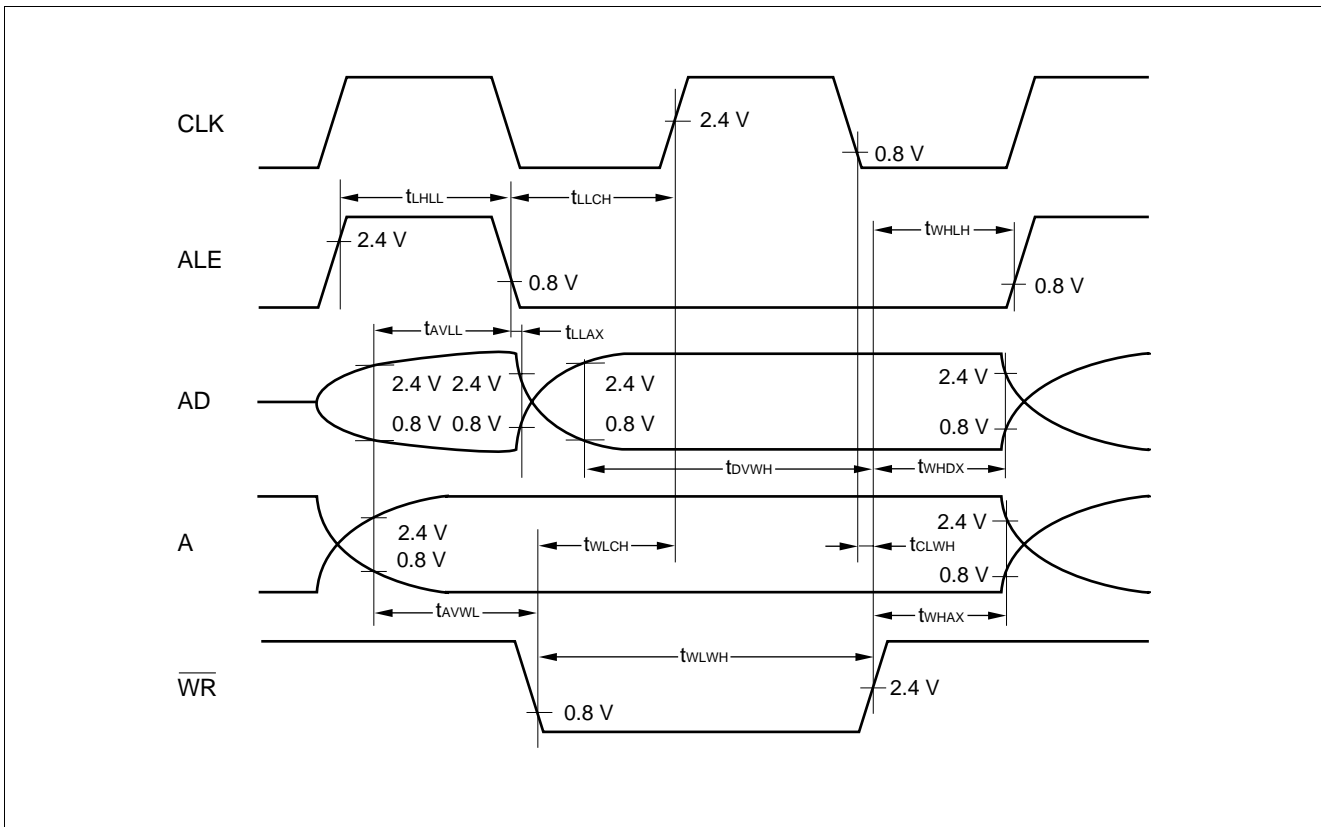

## (9) Ready Input Timing

( $V_{CC} = +5.0 V \pm 10\%$ ,  $F_C = 10 \text{ MHz}$ ,  $A_{VSS} = V_{SS} = 0.0 \text{ V}$ ,  $T_A = -40^\circ\text{C}$  to  $+85^\circ\text{C}$ )

Parameter	Symbol	Pin	Condition	Value		Unit	Remarks
				Min.	Max.		
RDY valid $\rightarrow$ CLK $\uparrow$ time	$t_{VCH}$	RDY, CLK	—	60	—	ns	*
CLK $\uparrow$ $\rightarrow$ RDY invalid time	$t_{CHYX}$			0	—	ns	*

\*: These characteristics are also applicable to the read cycle.

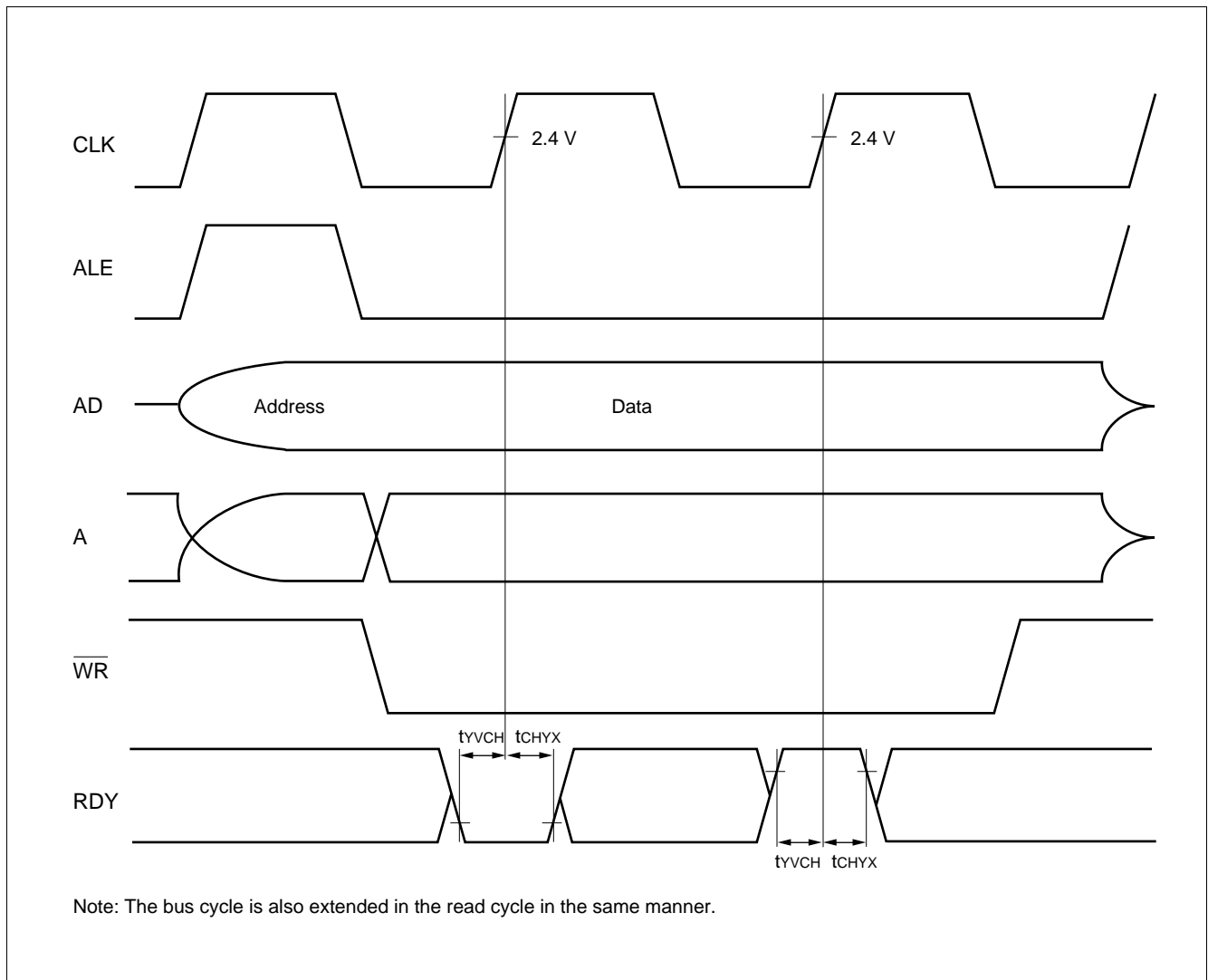

# MB89620 Series

## (10) Serial I/O Timing

( $V_{CC} = +5.0 V \pm 10\%$ ,  $AV_{SS} = V_{SS} = 0.0 V$ ,  $T_A = -40^\circ C$  to  $+85^\circ C$ )

Parameter	Symbol	Pin	Condition	Value		Unit	Remarks
				Min.	Max.		
Serial clock cycle time	$t_{SCYC}$	SCK1, SCK2	Internal shift clock mode	$2 t_{inst}^*$	—	$\mu s$	
SCK1 $\downarrow \rightarrow$ SO1 time SCK2 $\downarrow \rightarrow$ SO2 time	$t_{SLOV}$	SCK1, SO1 SCK2, SO2		-200	200	ns	
Valid SI1 $\rightarrow$ SCK1 $\uparrow$ Valid SI2 $\rightarrow$ SCK2 $\uparrow$	$t_{IVSH}$	SI1, SCK1 SI2, SCK2		$1/2 t_{inst}^*$	—	$\mu s$	
SCK1 $\uparrow \rightarrow$ valid SI1 hold time SCK2 $\uparrow \rightarrow$ valid SI2 hold time	$t_{SHIX}$	SCK1, SI1 SCK2, SI2		$1/2 t_{inst}^*$	—	$\mu s$	
Serial clock "H" pulse width	$t_{SHSL}$	SCK1, SCK2	External shift clock mode	$1 t_{inst}^*$	—	$\mu s$	
Serial clock "L" pulse width	$t_{LSLH}$	SCK1, SCK2		$1 t_{inst}^*$	—	$\mu s$	
SCK1 $\downarrow \rightarrow$ SO1 time SCK2 $\downarrow \rightarrow$ SO2 time	$t_{SLOV}$	SCK1, SO1 SCK2, SO2		0	200	ns	
Valid SI1 $\rightarrow$ SCK1 $\uparrow$ Valid SI2 $\rightarrow$ SCK2 $\uparrow$	$t_{IVSH}$	SI1, SCK1 SI2, SCK2		$1/2 t_{inst}^*$	—	$\mu s$	
SCK1 $\uparrow \rightarrow$ valid SI1 hold time SCK2 $\uparrow \rightarrow$ valid SI2 hold time	$t_{SHIX}$	SCK1, SI1 SCK2, SI2		$1/2 t_{inst}^*$	—	$\mu s$	

\*: For information on  $t_{inst}$ , see "(4) Instruction Cycle."



## Internal Shift Clock Mode

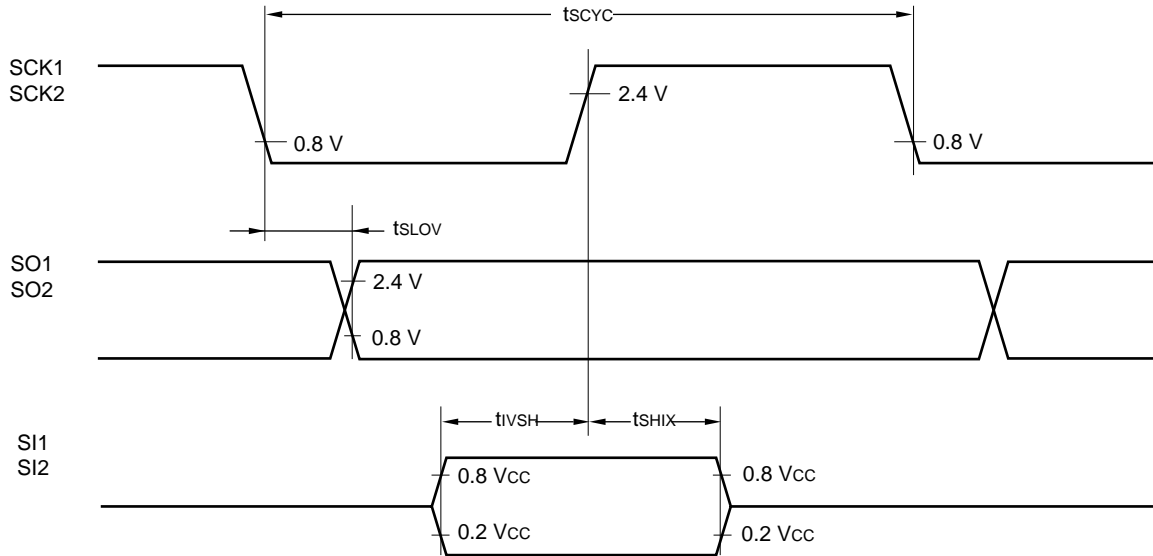

## External Shift Clock Mode

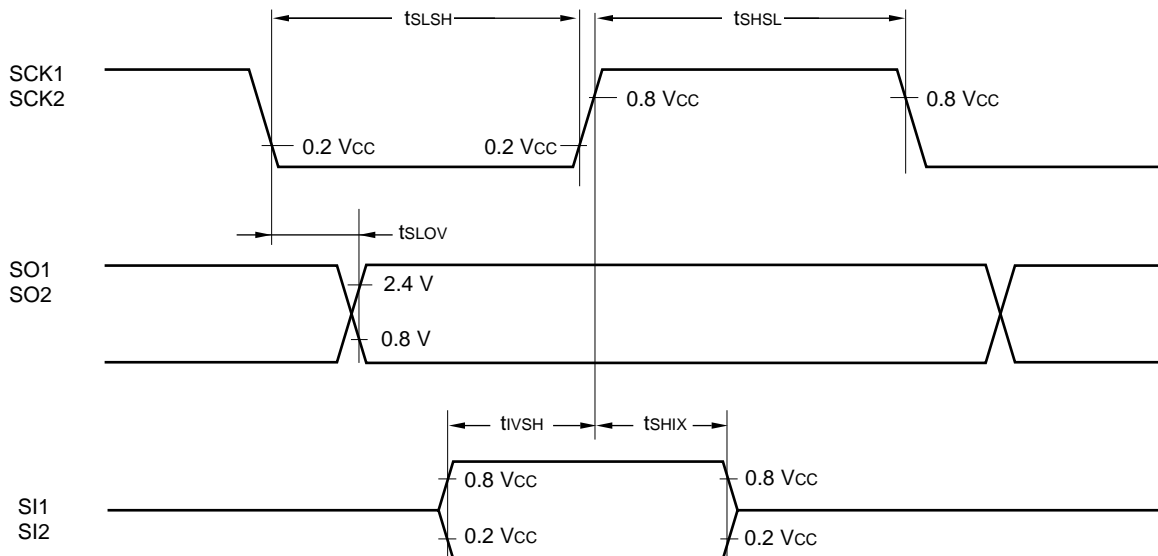

# MB89620 Series

## (11) Peripheral Input Timing

( $V_{CC} = +5.0 V \pm 10\%$ ,  $A_{V_{SS}} = V_{SS} = 0.0 V$ ,  $T_A = -40^\circ C$  to  $+85^\circ C$ )

Parameter	Symbol	Pin	Condition	Value		Unit	Remarks
				Min.	Max.		
Peripheral input "H" pulse width 1	$t_{ILIH1}$	PWC, EC, INT0 to INT3	—	$2 t_{inst}^*$	—	$\mu s$	
Peripheral input "L" pulse width 1	$t_{IHIL1}$			$2 t_{inst}^*$	—	$\mu s$	
Peripheral input "H" pulse width 2	$t_{ILIH2}$	ADST	A/D mode	$32 t_{inst}^*$	—	$\mu s$	
Peripheral input "L" pulse width 2	$t_{IHIL2}$			$32 t_{inst}^*$	—	$\mu s$	
Peripheral input "H" pulse width 2	$t_{ILIH2}$		Sense mode	$8 t_{inst}^*$	—	$\mu s$	
Peripheral input "L" pulse width 2	$t_{IHIL2}$			$8 t_{inst}^*$	—	$\mu s$	

\*: For information on  $t_{inst}$ , see "(4) Instruction Cycle."

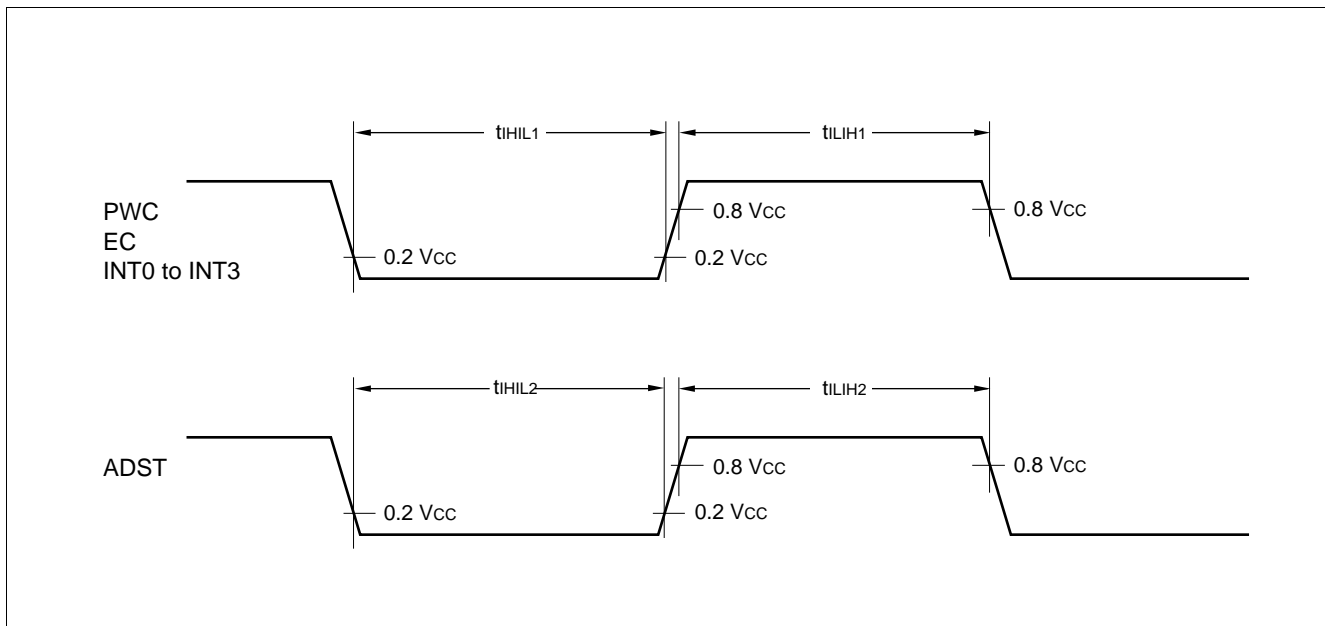

## 5. A/D Converter Electrical Characteristics

( $AV_{CC} = V_{CC} = +3.5\text{ V to }+6.0\text{ V}$ ,  $AV_{SS} = V_{SS} = 0.0\text{ V}$ ,  $T_A = -40^\circ\text{C to }+85^\circ\text{C}$ )

Parameter	Symbol	Pin	Condition	Value			Unit	Remarks
				Min.	Typ.	Max.		
Resolution			—	—	—	8	bit	
Total error			AVR = AV <sub>CC</sub>	—	—	±1.5	LSB	
Linearity error	—			—	—	±1.0	LSB	
Differential linearity error				—	—	±0.9	LSB	
Zero transition voltage	V <sub>OT</sub>			AV <sub>SS</sub> – 1.0 LSB	AV <sub>SS</sub> + 0.5 LSB	AV <sub>SS</sub> + 2.0 LSB	mV	
Full-scale transition voltage	V <sub>FST</sub>		AVR – 3.0 LSB	AVR – 1.5 LSB	AVR	mV		
Interchannel disparity				—	0.5	LSB		
A/D mode conversion time	—		—	—	44 t <sub>inst</sub> *	—	μs	
Sense mode conversion time				—	12 t <sub>inst</sub> *	—	μs	
Analog port input current	I <sub>AIN</sub>	AN0 to AN7		—	—	10	μA	
Analog input voltage	—			0.0	—	AVR	V	
Reference voltage	—			0.0	—	AV <sub>CC</sub>	V	
Reference voltage supply current	I <sub>R</sub>	AVR	AVR = 5.0 V, when A/D conversion is activated	—	100	—	μA	
	I <sub>RH</sub>		AVR = 5.0 V, when A/D conversion is stopped	—	—	1	μA	

\*: For information on t<sub>inst</sub>, see “(4) Instruction Cycle” in “4 AC Characteristics.”

### (1) A/D Glossary

- Resolution  
Analog changes that are identifiable with the A/D converter.  
When the number of bits is 8, analog voltage can be divided into  $2^8 = 256$ .
- Linearity error (unit: LSB)  
The deviation of the straight line connecting the zero transition point (“0000 0000” ↔ “0000 0001”) with the full-scale transition point (“1111 1111” ↔ “1111 1110”) from actual conversion characteristics
- Differential linearity error (unit: LSB)  
The deviation of input voltage needed to change the output code by 1 LSB from the theoretical value
- Total error (unit: LSB)  
The difference between theoretical and actual conversion values

# MB89620 Series

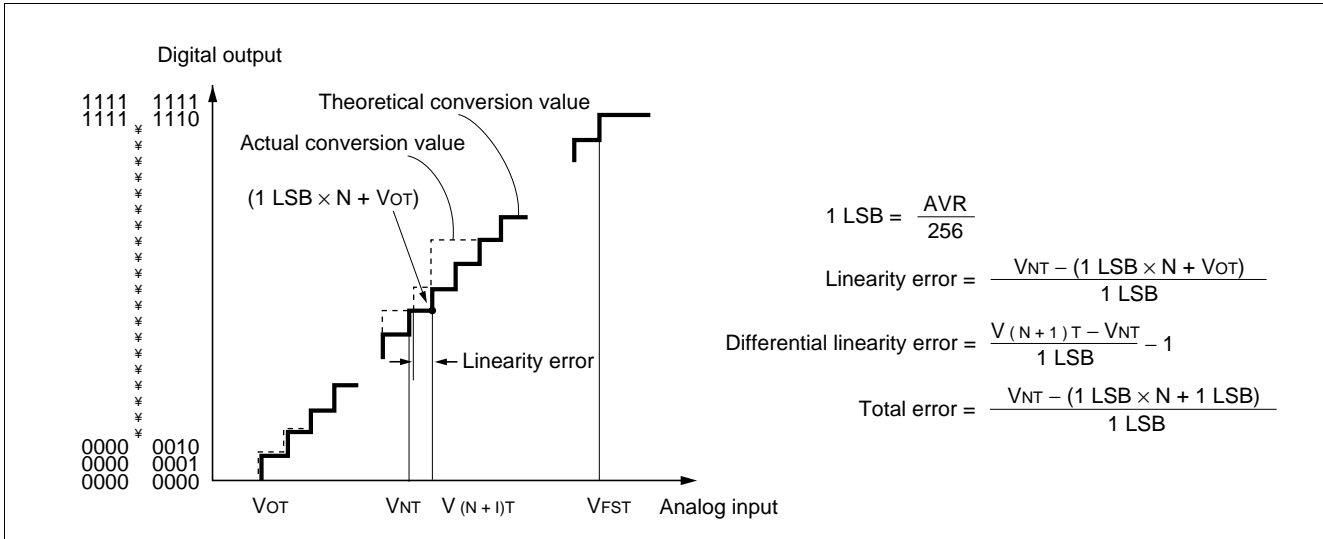

## (2) Precautions

### • Input impedance of the analog input pins

The A/D converter contains a sample hold circuit as illustrated below to fetch analog input voltage into the sample hold capacitor for eight instruction cycles after activating A/D conversion.

For this reason, if the output impedance of the external circuit for the analog input is high, analog input voltage might not stabilize within the analog input sampling period. Therefore, it is recommended to keep the output impedance of the external circuit low (below 10 kΩ).

Note that if the impedance cannot be kept low, it is recommended to connect an external capacitor of about 0.1 μF for the analog input pin.

### Analog Input Equivalent Circuit

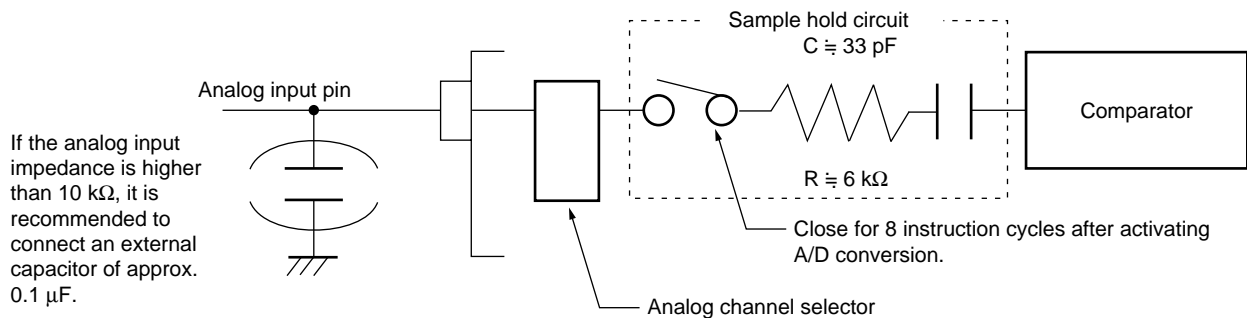

### • Error

The smaller the  $|AVR - AV_{SS}|$ , the greater the error would become relatively.

## EXAMPLE CHARACTERISTICS

(1) "L" Level Output Voltage

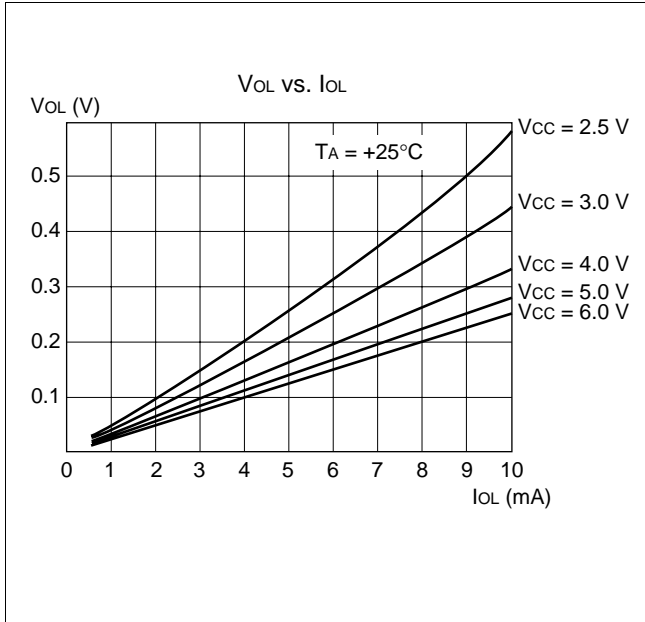

(2) "H" Level Output Voltage

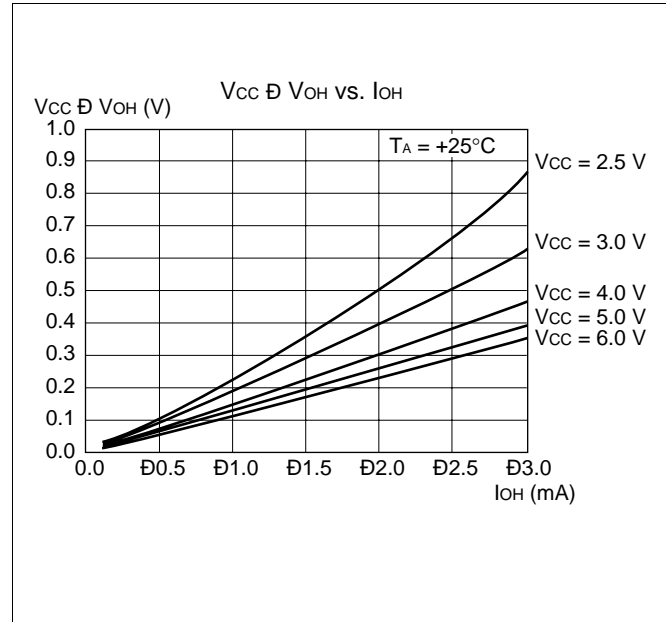

(3) "H" Level Input Voltage/"L" Level Input Voltage (CMOS Input)

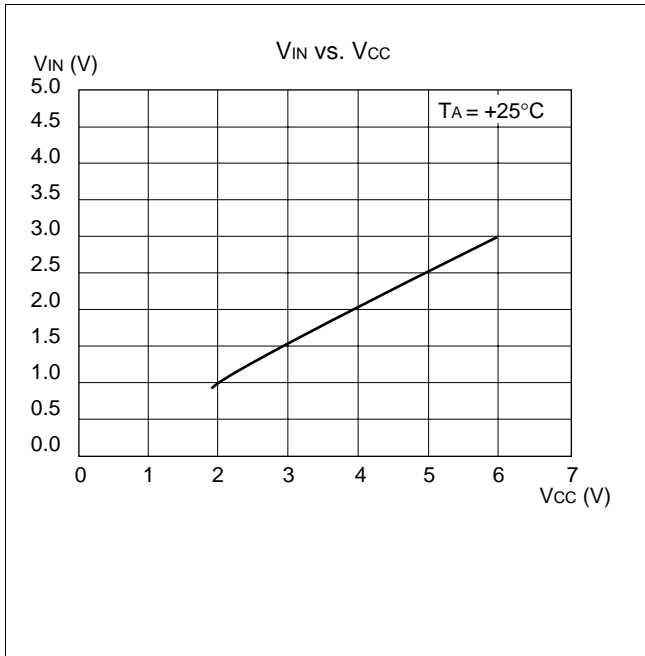

(4) "H" Level Input Voltage/"L" Level Input Voltage (Hysteresis Input)

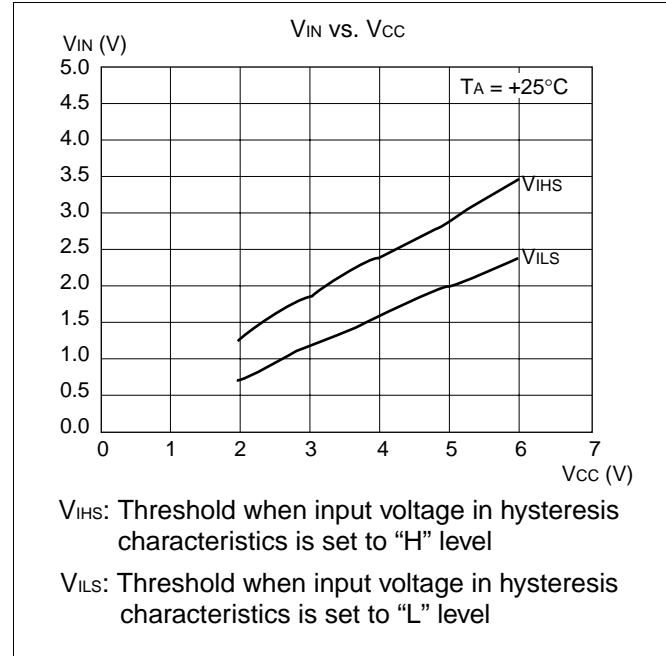

# MB89620 Series

## (5) Power Supply Current (External Clock)

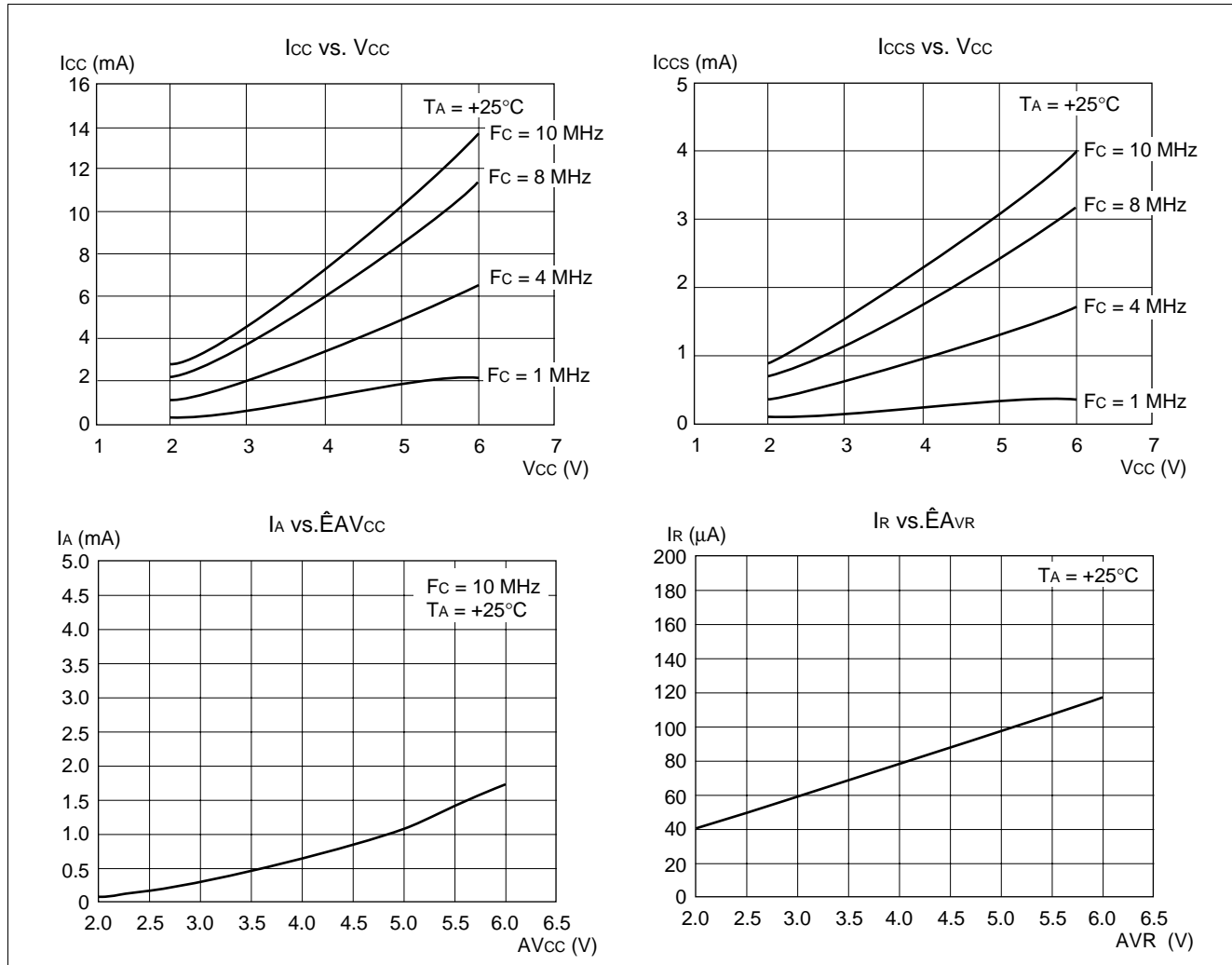

## (6) Pull-up Resistance

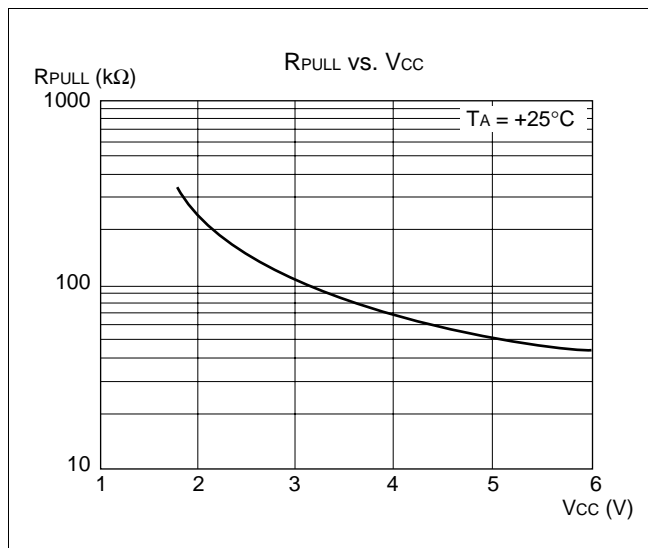

## ■ INSTRUCTIONS (136 INSTRUCTIONS)

Execution instructions can be divided into the following four groups:

- Transfer
- Arithmetic operation
- Branch
- Others

Table 1 lists symbols used for notation of instructions.

**Table 1 Instruction Symbols**

Symbol	Meaning
dir	Direct address (8 bits)
off	Offset (8 bits)
ext	Extended address (16 bits)
#vct	Vector table number (3 bits)
#d8	Immediate data (8 bits)
#d16	Immediate data (16 bits)
dir: b	Bit direct address (8:3 bits)
rel	Branch relative address (8 bits)
@	Register indirect (Example: @A, @IX, @EP)
A	Accumulator A (Whether its length is 8 or 16 bits is determined by the instruction in use.)
AH	Upper 8 bits of accumulator A (8 bits)
AL	Lower 8 bits of accumulator A (8 bits)
T	Temporary accumulator T (Whether its length is 8 or 16 bits is determined by the instruction in use.)
TH	Upper 8 bits of temporary accumulator T (8 bits)
TL	Lower 8 bits of temporary accumulator T (8 bits)
IX	Index register IX (16 bits)
EP	Extra pointer EP (16 bits)
PC	Program counter PC (16 bits)
SP	Stack pointer SP (16 bits)
PS	Program status PS (16 bits)
dr	Accumulator A or index register IX (16 bits)
CCR	Condition code register CCR (8 bits)
RP	Register bank pointer RP (5 bits)
Ri	General-purpose register Ri (8 bits, i = 0 to 7)
×	Indicates that the very × is the immediate data. (Whether its length is 8 or 16 bits is determined by the instruction in use.)
(×)	Indicates that the contents of × is the target of accessing. (Whether its length is 8 or 16 bits is determined by the instruction in use.)
((×))	The address indicated by the contents of × is the target of accessing. (Whether its length is 8 or 16 bits is determined by the instruction in use.)

Columns indicate the following:

Mnemonic: Assembler notation of an instruction

~: The number of instructions

#: The number of bytes

Operation: Operation of an instruction

TL, TH, AH: A content change when each of the TL, TH, and AH instructions is executed. Symbols in the column indicate the following:

- “—” indicates no change.
- dH is the 8 upper bits of operation description data.
- AL and AH must become the contents of AL and AH prior to the instruction executed.
- 00 becomes 00.

N, Z, V, C: An instruction of which the corresponding flag will change. If + is written in this column, the relevant instruction will change its corresponding flag.

OP code: Code of an instruction. If an instruction is more than one code, it is written according to the following rule:  
Example: 48 to 4F ← This indicates 48, 49, ... 4F.

# MB89620 Series

Table 2 Transfer Instructions (48 instructions)

Mnemonic	~	#	Operation	TL	TH	AH	NZVC	OP code
MOV dir,A	3	2	(dir) ← (A)	-	-	-	----	45
MOV @IX +off,A	4	2	((IX) +off) ← (A)	-	-	-	----	46
MOV ext,A	4	3	(ext) ← (A)	-	-	-	----	61
MOV @EP,A	3	1	((EP)) ← (A)	-	-	-	----	47
MOV Ri,A	3	1	(Ri) ← (A)	-	-	-	----	48 to 4F
MOV A,#d8	2	2	(A) ← d8	AL	-	-	++--	04
MOV A,dir	3	2	(A) ← (dir)	AL	-	-	++--	05
MOV A,@IX +off	4	2	(A) ← ((IX) +off)	AL	-	-	++--	06
MOV A,ext	4	3	(A) ← (ext)	AL	-	-	++--	60
MOV A,@A	3	1	(A) ← ((A))	AL	-	-	++--	92
MOV A,@EP	3	1	(A) ← ((EP))	AL	-	-	++--	07
MOV A,Ri	3	1	(A) ← (Ri)	AL	-	-	++--	08 to 0F
MOV dir,#d8	4	3	(dir) ← d8	-	-	-	----	85
MOV @IX +off,#d8	5	3	((IX) +off) ← d8	-	-	-	----	86
MOV @EP,#d8	4	2	((EP)) ← d8	-	-	-	----	87
MOV Ri,#d8	4	2	(Ri) ← d8	-	-	-	----	88 to 8F
MOVW dir,A	4	2	(dir) ← (AH),(dir + 1) ← (AL)	-	-	-	----	D5
MOVW @IX +off,A	5	2	((IX) +off) ← (AH), ((IX) +off + 1) ← (AL)	-	-	-	----	D6
MOVW ext,A	5	3	(ext) ← (AH), (ext + 1) ← (AL)	-	-	-	----	D4
MOVW @EP,A	4	1	((EP)) ← (AH),(EP) + 1) ← (AL)	-	-	-	----	D7
MOVW EP,A	2	1	(EP) ← (A)	-	-	-	----	E3
MOVW A,#d16	3	3	(A) ← d16	AL	AH	dH	++--	E4
MOVW A,dir	4	2	(AH) ← (dir), (AL) ← (dir + 1)	AL	AH	dH	++--	C5
MOVW A,@IX +off	5	2	(AH) ← ((IX) +off), (AL) ← ((IX) +off + 1)	AL	AH	dH	++--	C6
MOVW A,ext	5	3	(AH) ← (ext), (AL) ← (ext + 1)	AL	AH	dH	++--	C4
MOVW A,@A	4	1	(AH) ← ((A)), (AL) ← ((A) + 1)	AL	AH	dH	++--	93
MOVW A,@EP	4	1	(AH) ← ((EP)), (AL) ← ((EP) + 1)	AL	AH	dH	++--	C7
MOVW A,EP	2	1	(A) ← (EP)	-	-	dH	----	F3
MOVW EP,#d16	3	3	(EP) ← d16	-	-	-	----	E7
MOVW IX,A	2	1	(IX) ← (A)	-	-	-	----	E2
MOVW A,IX	2	1	(A) ← (IX)	-	-	dH	----	F2
MOVW SP,A	2	1	(SP) ← (A)	-	-	-	----	E1
MOVW A,SP	2	1	(A) ← (SP)	-	-	dH	----	F1
MOV @A,T	3	1	((A)) ← (T)	-	-	-	----	82
MOVW @A,T	4	1	((A)) ← (TH),(A) + 1) ← (TL)	-	-	-	----	83
MOVW IX,#d16	3	3	(IX) ← d16	-	-	-	----	E6
MOVW A,PS	2	1	(A) ← (PS)	-	-	dH	----	70
MOVW PS,A	2	1	(PS) ← (A)	-	-	-	++++	71
MOVW SP,#d16	3	3	(SP) ← d16	-	-	-	----	E5
SWAP	2	1	(AH) ↔ (AL)	-	-	AL	----	10
SETB dir: b	4	2	(dir): b ← 1	-	-	-	----	A8 to AF
CLRB dir: b	4	2	(dir): b ← 0	-	-	-	----	A0 to A7
XCH A,T	2	1	(A) ↔ (T)	AL	-	-	----	42
XCHW A,T	3	1	(A) ↔ (T)	AL	AH	dH	----	43
XCHW A,EP	3	1	(A) ↔ (EP)	-	-	dH	----	F7
XCHW A,IX	3	1	(A) ↔ (IX)	-	-	dH	----	F6
XCHW A,SP	3	1	(A) ↔ (SP)	-	-	dH	----	F5
MOVW A,PC	2	1	(A) ← (PC)	-	-	dH	----	F0

Note: During byte transfer to A, T ← A is restricted to low bytes.

Operands in more than one operand instruction must be stored in the order in which their mnemonics are written. (Reverse arrangement of F<sup>2</sup>MC-8 family)



**Table 3 Arithmetic Operation Instructions (62 instructions)**

Mnemonic	~	#	Operation	TL	TH	AH	NZVC	OP code
ADDC A,Ri	3	1	$(A) \leftarrow (A) + (Ri) + C$	-	-	-	++++	28 to 2F
ADDC A,#d8	2	2	$(A) \leftarrow (A) + d8 + C$	-	-	-	++++	24
ADDC A,dir	3	2	$(A) \leftarrow (A) + (dir) + C$	-	-	-	++++	25
ADDC A,@IX +off	4	2	$(A) \leftarrow (A) + ((IX) + off) + C$	-	-	-	++++	26
ADDC A,@EP	3	1	$(A) \leftarrow (A) + ((EP)) + C$	-	-	-	++++	27
ADDCW A	3	1	$(A) \leftarrow (A) + (T) + C$	-	-	dH	++++	23
ADDC A	2	1	$(AL) \leftarrow (AL) + (TL) + C$	-	-	-	++++	22
SUBC A,Ri	3	1	$(A) \leftarrow (A) - (Ri) - C$	-	-	-	++++	38 to 3F
SUBC A,#d8	2	2	$(A) \leftarrow (A) - d8 - C$	-	-	-	++++	34
SUBC A,dir	3	2	$(A) \leftarrow (A) - (dir) - C$	-	-	-	++++	35
SUBC A,@IX +off	4	2	$(A) \leftarrow (A) - ((IX) + off) - C$	-	-	-	++++	36
SUBC A,@EP	3	1	$(A) \leftarrow (A) - ((EP)) - C$	-	-	-	++++	37
SUBCW A	3	1	$(A) \leftarrow (T) - (A) - C$	-	-	dH	++++	33
SUBC A	2	1	$(AL) \leftarrow (TL) - (AL) - C$	-	-	-	++++	32
INC Ri	4	1	$(Ri) \leftarrow (Ri) + 1$	-	-	-	+++-	C8 to CF
INCW EP	3	1	$(EP) \leftarrow (EP) + 1$	-	-	-	----	C3
INCW IX	3	1	$(IX) \leftarrow (IX) + 1$	-	-	-	----	C2
INCW A	3	1	$(A) \leftarrow (A) + 1$	-	-	dH	+- - -	C0
DEC Ri	4	1	$(Ri) \leftarrow (Ri) - 1$	-	-	-	+++-	D8 to DF
DECW EP	3	1	$(EP) \leftarrow (EP) - 1$	-	-	-	----	D3
DECW IX	3	1	$(IX) \leftarrow (IX) - 1$	-	-	-	----	D2
DECW A	3	1	$(A) \leftarrow (A) - 1$	-	-	dH	+- - -	D0
MULU A	19	1	$(A) \leftarrow (AL) \times (TL)$	-	-	dH	----	01
DIVU A	21	1	$(A) \leftarrow (T) / (AL), MOD \rightarrow (T)$	dL	00	00	----	11
ANDW A	3	1	$(A) \leftarrow (A) \wedge (T)$	-	-	dH	++ R -	63
ORW A	3	1	$(A) \leftarrow (A) \vee (T)$	-	-	dH	++ R -	73
XORW A	3	1	$(A) \leftarrow (A) \nabla (T)$	-	-	dH	++ R -	53
CMP A	2	1	$(TL) - (AL)$	-	-	-	++++	12
CMPW A	3	1	$(T) - (A)$	-	-	-	++++	13
RORC A	2	1	<div style="border: 1px solid black; display: inline-block; padding: 2px;"> <math>\rightarrow C \rightarrow A</math> </div>	-	-	-	++ - +	03
ROLC A	2	1	<div style="border: 1px solid black; display: inline-block; padding: 2px;"> <math>C \leftarrow A \leftarrow</math> </div>	-	-	-	++ - +	02
CMP A,#d8	2	2	$(A) - d8$	-	-	-	++++	14
CMP A,dir	3	2	$(A) - (dir)$	-	-	-	++++	15
CMP A,@EP	3	1	$(A) - ((EP))$	-	-	-	++++	17
CMP A,@IX +off	4	2	$(A) - ((IX) + off)$	-	-	-	++++	16
CMP A,Ri	3	1	$(A) - (Ri)$	-	-	-	++++	18 to 1F
DAA	2	1	Decimal adjust for addition	-	-	-	++++	84
DAS	2	1	Decimal adjust for subtraction	-	-	-	++++	94
XOR A	2	1	$(A) \leftarrow (AL) \nabla (TL)$	-	-	-	++ R -	52
XOR A,#d8	2	2	$(A) \leftarrow (AL) \nabla d8$	-	-	-	++ R -	54
XOR A,dir	3	2	$(A) \leftarrow (AL) \nabla (dir)$	-	-	-	++ R -	55
XOR A,@EP	3	1	$(A) \leftarrow (AL) \nabla ((EP))$	-	-	-	++ R -	57
XOR A,@IX +off	4	2	$(A) \leftarrow (AL) \nabla ((IX) + off)$	-	-	-	++ R -	56
XOR A,Ri	3	1	$(A) \leftarrow (AL) \nabla (Ri)$	-	-	-	++ R -	58 to 5F
AND A	2	1	$(A) \leftarrow (AL) \wedge (TL)$	-	-	-	++ R -	62
AND A,#d8	2	2	$(A) \leftarrow (AL) \wedge d8$	-	-	-	++ R -	64
AND A,dir	3	2	$(A) \leftarrow (AL) \wedge (dir)$	-	-	-	++ R -	65

(Continued)

# MB89620 Series

(Continued)

Mnemonic	~	#	Operation	TL	TH	AH	NZVC	OP code
AND A,@EP	3	1	$(A) \leftarrow (AL) \wedge (EP)$	-	-	-	++R-	67
AND A,@IX +off	4	2	$(A) \leftarrow (AL) \wedge ((IX) + \text{off})$	-	-	-	++R-	66
AND A,Ri	3	1	$(A) \leftarrow (AL) \wedge (Ri)$	-	-	-	++R-	68 to 6F
OR A	2	1	$(A) \leftarrow (AL) \vee (TL)$	-	-	-	++R-	72
OR A,#d8	2	2	$(A) \leftarrow (AL) \vee d8$	-	-	-	++R-	74
OR A,dir	3	2	$(A) \leftarrow (AL) \vee (\text{dir})$	-	-	-	++R-	75
OR A,@EP	3	1	$(A) \leftarrow (AL) \vee (EP)$	-	-	-	++R-	77
OR A,@IX +off	4	2	$(A) \leftarrow (AL) \vee ((IX) + \text{off})$	-	-	-	++R-	76
OR A,Ri	3	1	$(A) \leftarrow (AL) \vee (Ri)$	-	-	-	++R-	78 to 7F
CMP dir,#d8	5	3	$(\text{dir}) - d8$	-	-	-	++++	95
CMP @EP,#d8	4	2	$(EP) - d8$	-	-	-	++++	97
CMP @IX +off,#d8	5	3	$((IX) + \text{off}) - d8$	-	-	-	++++	96
CMP Ri,#d8	4	2	$(Ri) - d8$	-	-	-	++++	98 to 9F
INCW SP	3	1	$(SP) \leftarrow (SP) + 1$	-	-	-	----	C1
DECW SP	3	1	$(SP) \leftarrow (SP) - 1$	-	-	-	----	D1

**Table 4 Branch Instructions (17 instructions)**

Mnemonic	~	#	Operation	TL	TH	AH	NZVC	OP code
BZ/BEQ rel	3	2	If $Z = 1$ then $PC \leftarrow PC + \text{rel}$	-	-	-	----	FD
BNZ/BNE rel	3	2	If $Z = 0$ then $PC \leftarrow PC + \text{rel}$	-	-	-	----	FC
BC/BLO rel	3	2	If $C = 1$ then $PC \leftarrow PC + \text{rel}$	-	-	-	----	F9
BNC/BHS rel	3	2	If $C = 0$ then $PC \leftarrow PC + \text{rel}$	-	-	-	----	F8
BN rel	3	2	If $N = 1$ then $PC \leftarrow PC + \text{rel}$	-	-	-	----	FB
BP rel	3	2	If $N = 0$ then $PC \leftarrow PC + \text{rel}$	-	-	-	----	FA
BLT rel	3	2	If $V \vee N = 1$ then $PC \leftarrow PC + \text{rel}$	-	-	-	----	FF
BGE rel	3	2	If $V \vee N = 0$ then $PC \leftarrow PC + \text{rel}$	-	-	-	----	FE
BBC dir: b,rel	5	3	If $(\text{dir: } b) = 0$ then $PC \leftarrow PC + \text{rel}$	-	-	-	-+---	B0 to B7
BBS dir: b,rel	5	3	If $(\text{dir: } b) = 1$ then $PC \leftarrow PC + \text{rel}$	-	-	-	-+---	B8 to BF
JMP @A	2	1	$(PC) \leftarrow (A)$	-	-	-	----	E0
JMP ext	3	3	$(PC) \leftarrow \text{ext}$	-	-	-	----	21
CALLV #vct	6	1	Vector call	-	-	-	----	E8 to EF
CALL ext	6	3	Subroutine call	-	-	-	----	31
XCHW A,PC	3	1	$(PC) \leftarrow (A), (A) \leftarrow (PC) + 1$	-	-	dH	----	F4
RET	4	1	Return from subroutine	-	-	-	----	20
RETI	6	1	Return from interrupt	-	-	-	Restore	30

**Table 5 Other Instructions (9 instructions)**

Mnemonic	~	#	Operation	TL	TH	AH	NZVC	OP code
PUSHW A	4	1		-	-	-	----	40
POPW A	4	1		-	-	dH	----	50
PUSHW IX	4	1		-	-	-	----	41
POPW IX	4	1		-	-	-	----	51
NOP	1	1		-	-	-	----	00
CLRC	1	1		-	-	-	----R	81
SETC	1	1		-	-	-	----S	91
CLRI	1	1		-	-	-	----	80
SETI	1	1		-	-	-	----	90

## INSTRUCTION MAP

L	H	0	1	2	3	4	5	6	7	8	9	A	B	C	D	E	F
0	NOP	SWAP	RET	RETI	PUSHW A	PUSHW IX	POPW A	MOV A,ext	MOVW A,PS	CLR I	SETI	CLRB dir: 0	BBC dir: 0,rel	INCW A	DECW A	JMP @A	MOVW A,PC
1	MULU A	DIVU A	JMP addr16	CALL addr16	PUSHW IX	PUSHW IX	POPW PS,A	MOV ext,A	MOVW PS,A	CLRC	SETC	CLRB dir: 1	BBC dir: 1,rel	INCW SP	DECW SP	MOVW SPA	MOVW A,SP
2	ROL A	CMP A	ADDC A	SUBC A	XCH A,T	XCH A,T	XOR A	AND A	OR A	MOV @A,T	MOV A,@A	CLRB dir: 2	BBC dir: 2,rel	INCW IX	DECW IX	MOVW IX,A	MOVW A,IX
3	RORC A	CMPW A	ADDCW A	SUBCW A	XCHW A,T	XCHW A,T	XORW A	ANDW A	ORW A	MOVW @A,T	MOVW A,@A	CLRB dir: 3	BBC dir: 3,rel	INCW EP	DECW EP	MOVW EPA	MOVW A,EP
4	MOV A,#d8	CMP A,#d8	ADDC A,#d8	SUBC A,#d8	XOR A,#d8	XOR A,#d8	XOR A,#d8	AND A,#d8	OR A,#d8	DAA	DAS	CLRB dir: 4	BBC dir: 4,rel	MOVW A,ext	MOVW ext,A	MOVW A,#d16	XCHW A,PC
5	MOV A,dir	CMP A,dir	ADDC A,dir	SUBC A,dir	XOR A,dir	XOR A,dir	XOR A,dir	AND A,dir	OR A,dir	MOV dir,#d8	CMP dir,#d8	CLRB dir: 5	BBC dir: 5,rel	MOVW A,dir	MOVW dir,A	MOVW SP#d16	XCHW A,SP
6	MOV A,@IX+d	CMP A,@IX+d	ADDC A,@IX+d	SUBC A,@IX+d	XOR A,@IX+d	XOR A,@IX+d	XOR A,@IX+d	AND A,@IX+d	OR A,@IX+d	MOV @IX+d,#d8	CMP @IX+d,#d8	CLRB dir: 6	BBC dir: 6,rel	MOVW A,@IX+d	MOVW @IX+d,A	MOVW IX,#d16	XCHW A,IX
7	MOV A,@EP	CMP A,@EP	ADDC A,@EP	SUBC A,@EP	XOR A,@EP	XOR A,@EP	XOR A,@EP	AND A,@EP	OR A,@EP	MOV @EP,#d8	CMP @EP,#d8	CLRB dir: 7	BBC dir: 7,rel	MOVW A,@EP	MOVW @EPA	MOVW EP#d16	XCHW A,EP
8	MOV A,R0	CMP A,R0	ADDC A,R0	SUBC A,R0	XOR R0,A	MOV R0,A	XOR A,R0	AND A,R0	OR A,R0	MOV R0,#d8	CMP R0,#d8	SETB dir: 0	BBS dir: 0,rel	INC R0	DEC R0	CALLV #0	BNC rel
9	MOV A,R1	CMP A,R1	ADDC A,R1	SUBC A,R1	MOV R1,A	MOV A,R1	XOR A,R1	AND A,R1	OR A,R1	MOV R1,#d8	CMP R1,#d8	SETB dir: 1	BBS dir: 1,rel	INC R1	DEC R1	CALLV #1	BC rel
A	MOV A,R2	CMP A,R2	ADDC A,R2	SUBC A,R2	MOV R2,A	MOV A,R2	XOR A,R2	AND A,R2	OR A,R2	MOV R2,#d8	CMP R2,#d8	SETB dir: 2	BBS dir: 2,rel	INC R2	DEC R2	CALLV #2	BP rel
B	MOV A,R3	CMP A,R3	ADDC A,R3	SUBC A,R3	MOV R3,A	MOV A,R3	XOR A,R3	AND A,R3	OR A,R3	MOV R3,#d8	CMP R3,#d8	SETB dir: 3	BBS dir: 3,rel	INC R3	DEC R3	CALLV #3	BN rel
C	MOV A,R4	CMP A,R4	ADDC A,R4	SUBC A,R4	MOV R4,A	MOV A,R4	XOR A,R4	AND A,R4	OR A,R4	MOV R4,#d8	CMP R4,#d8	SETB dir: 4	BBS dir: 4,rel	INC R4	DEC R4	CALLV #4	BNZ rel
D	MOV A,R5	CMP A,R5	ADDC A,R5	SUBC A,R5	MOV R5,A	MOV A,R5	XOR A,R5	AND A,R5	OR A,R5	MOV R5,#d8	CMP R5,#d8	SETB dir: 5	BBS dir: 5,rel	INC R5	DEC R5	CALLV #5	BZ rel
E	MOV A,R6	CMP A,R6	ADDC A,R6	SUBC A,R6	MOV R6,A	MOV A,R6	XOR A,R6	AND A,R6	OR A,R6	MOV R6,#d8	CMP R6,#d8	SETB dir: 6	BBS dir: 6,rel	INC R6	DEC R6	CALLV #6	BGE rel
F	MOV A,R7	CMP A,R7	ADDC A,R7	SUBC A,R7	MOV R7,A	MOV A,R7	XOR A,R7	AND A,R7	OR A,R7	MOV R7,#d8	CMP R7,#d8	SETB dir: 7	BBS dir: 7,rel	INC R7	DEC R7	CALLV #7	BLT rel

# MB89620 Series

## ■ MASK OPTIONS

No.	Part number	MB89623 MB89625 MB89626 MB89627	MB89P625 MB89W625 MB89P627 MB89W627	MB89PV620 MB89V623 MB89T623 MB89T625
	Specifying procedure	Specify when ordering masking	Set with EPROM programmer	Setting not possible
1	Pull-up resistors P00 to P07, P10 to P17, P30 to P37, P40 to P47, P50 to P57, P60 to P64	Selectable per pin. (P50 to P57 must be set to without a pull-up resistor when an A/D converter is used.)	Can be set per pin. (P40 to P47 are available only for without a pull-up resistor.)	Fixed to without pull-up resistor
2	Power-on reset selection With power-on reset Without power-on reset	Selectable	Setting possible	Fixed to with power-on reset
3	Oscillation stabilization time selection Crystal oscillator: $2^{18}/F_c(s)$ Ceramic oscillator: $2^{14}/F_c(s)$	Selectable	Setting possible	Crystal oscillator ( $2^{18}/F_c(s)$ )
4	Reset pin output With reset output Without reset output	Selectable	Setting possible	With reset output

Note: Reset is input asynchronized with the internal clock whether with or without power-on reset.

## ■ ORDERING INFORMATION

Part number	Package	Remarks
MB89623P-SH MB89625P-SH MB89626P-SH MB89627P-SH MB89P625P-SH MB89P627-SH MB89T623P-SH MB89T625P-SH MB89V623P-SH MB89V625P-SH	64-pin Plastic SH-DIP (DIP-64P-M01)	*
MB89623PFV MB89625PFV MB89T623PFV MB89T625PFV	64-pin Plastic SQFP (FPT-64P-M03)	Lead pitch: 0.5 mm *
MB89623PF MB89625PF MB89626PF MB89627PF MB89P625PF MB89P627PF MB89T623PF MB89T625PF	64-pin Plastic QFP (FPT-64P-M06)	Lead pitch: 1.0 mm *
MB89623PFM MB89625PFM MB89626PFM MB89627PFM MB89P625PFM MB89P627PFM MB89T623PFM MB89T625PFM	64-pin Plastic QFP (FPT-64P-M09)	Lead pitch: 0.65 mm *
MB89W625C-SH MB89W627C-SH	64-pin Ceramic SH-DIP (DIP-64C-A06)	
MB89PV620C-SH	64-pin Ceramic MDIP (MDP-64C-P02)	
MB89PV620CF	64-pin Ceramic MQFP (MQP-64C-P01)	

\*: MB89623x, MB89625x, MB89626x and MB89627x can not be ordered.  
Please order MB89620R instead of those.

# MB89620 Series

## ■ PACKAGE DIMENSIONS

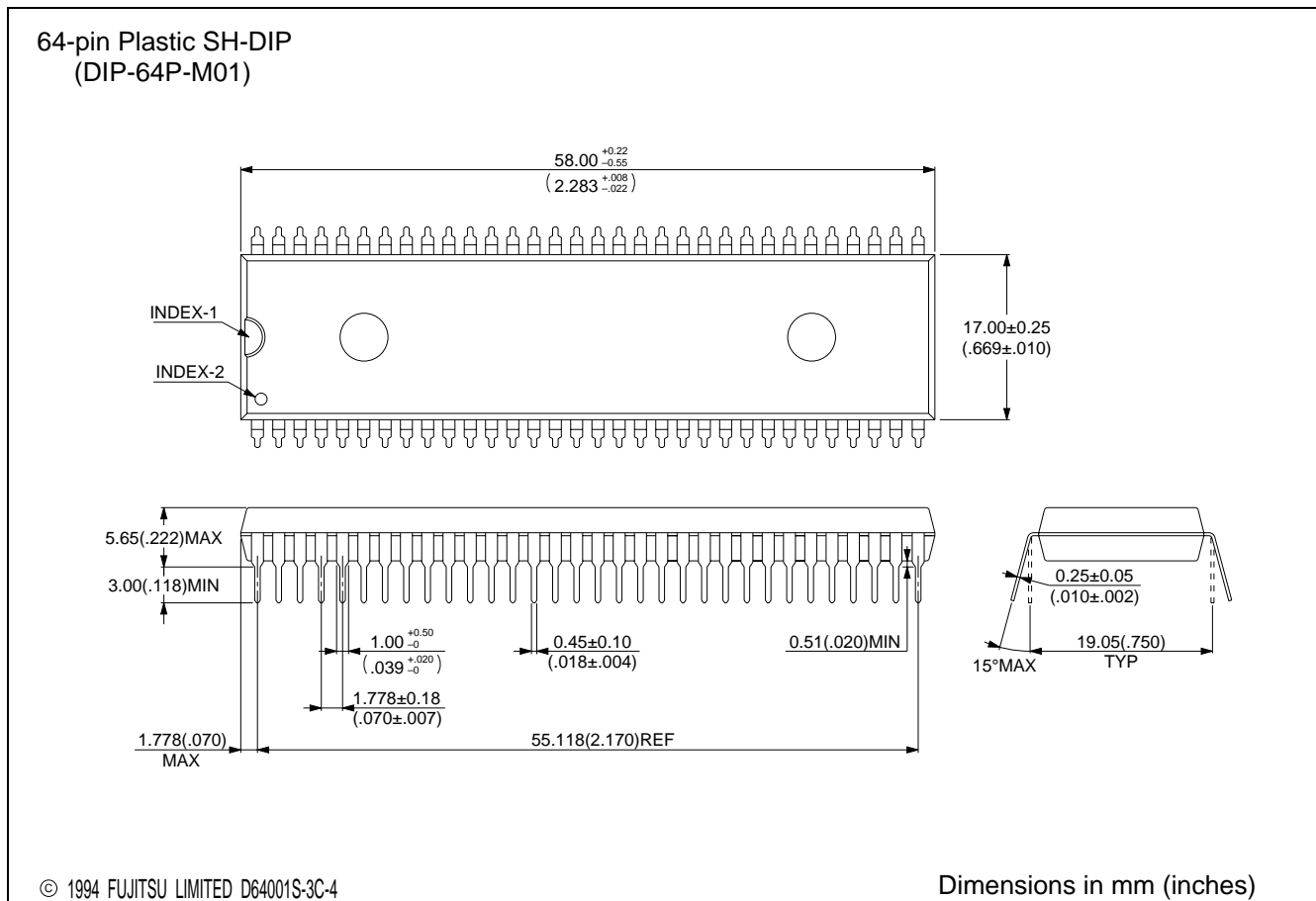

(Continued)

# MB89620 Series

(Continued)

## 64-pin Plastic SQFP (FPT-64P-M03)

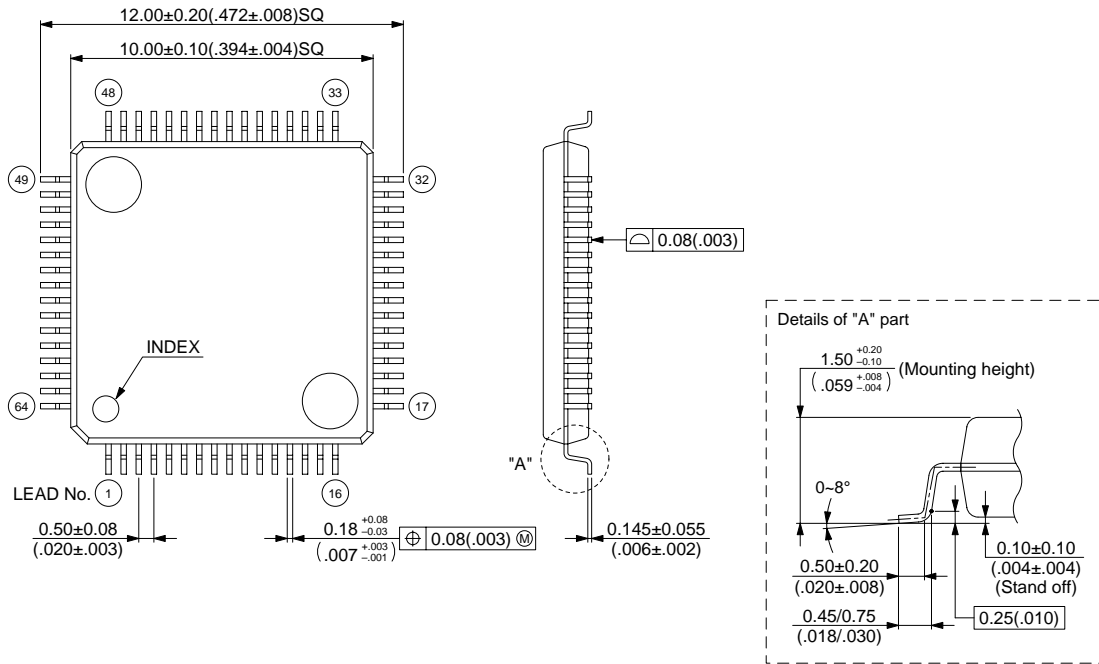

© 1998 FUJITSU LIMITED F64009S-3C-6

Dimensions in mm (inches)

(Continued)

# MB89620 Series

(Continued)

64-pin Plastic QFP  
(FPT-64P-M06)

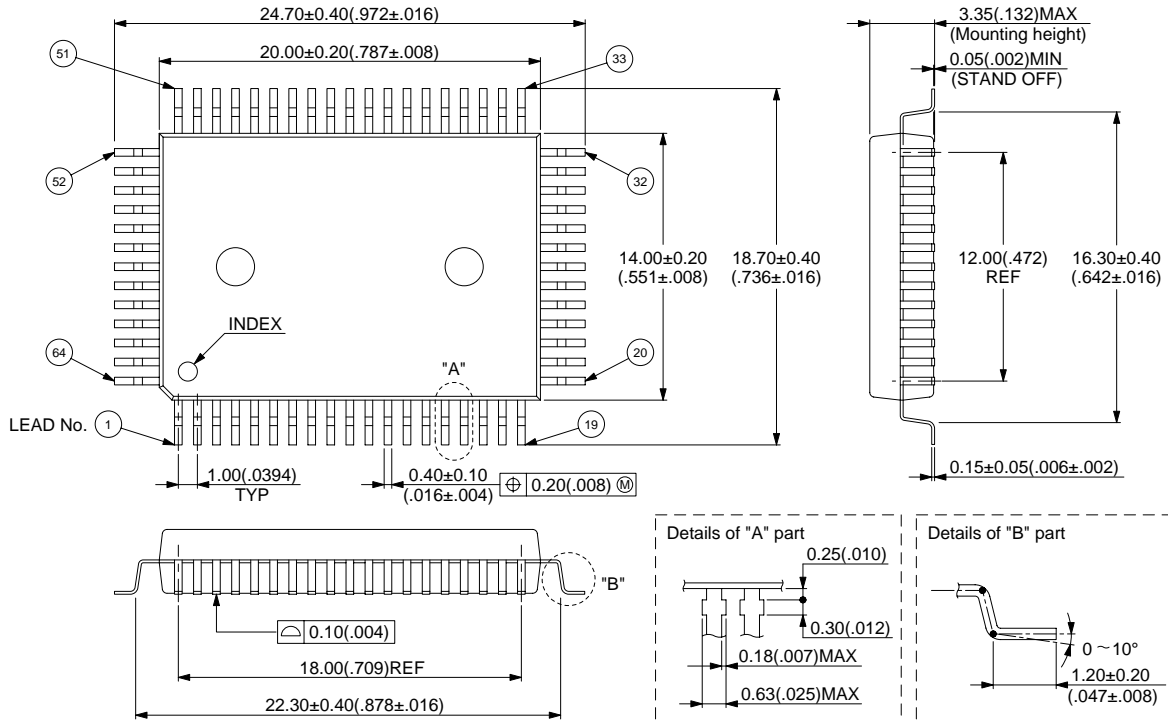

© 2000 FUJITSU LIMITED F64013S-3C-3

Dimensions in mm (inches)

(Continued)



(Continued)

64-pin Plastic QFP  
(FPT-64P-M09)

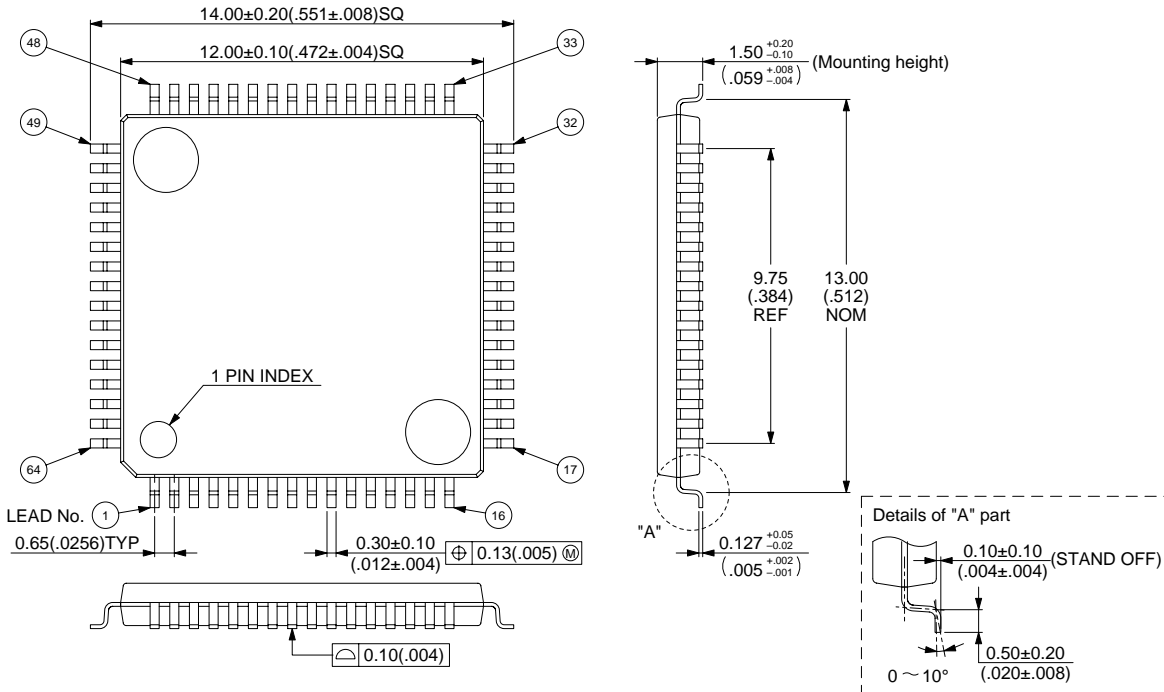

© 2000 FUJITSU LIMITED F64018S-1C-3

Dimensions in mm (inches)

(Continued)

# MB89620 Series

(Continued)

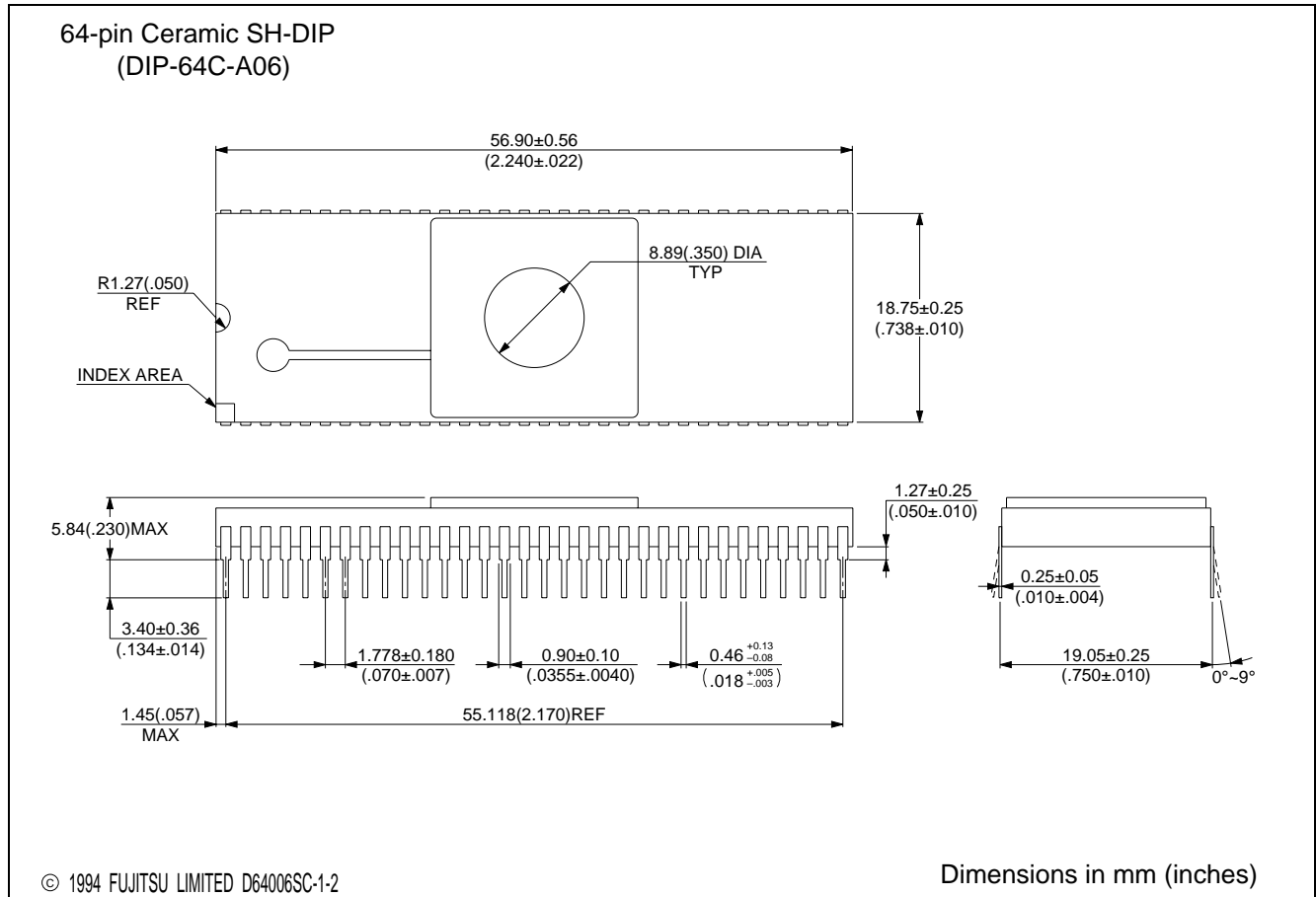

(Continued)

# MB89620 Series

(Continued)

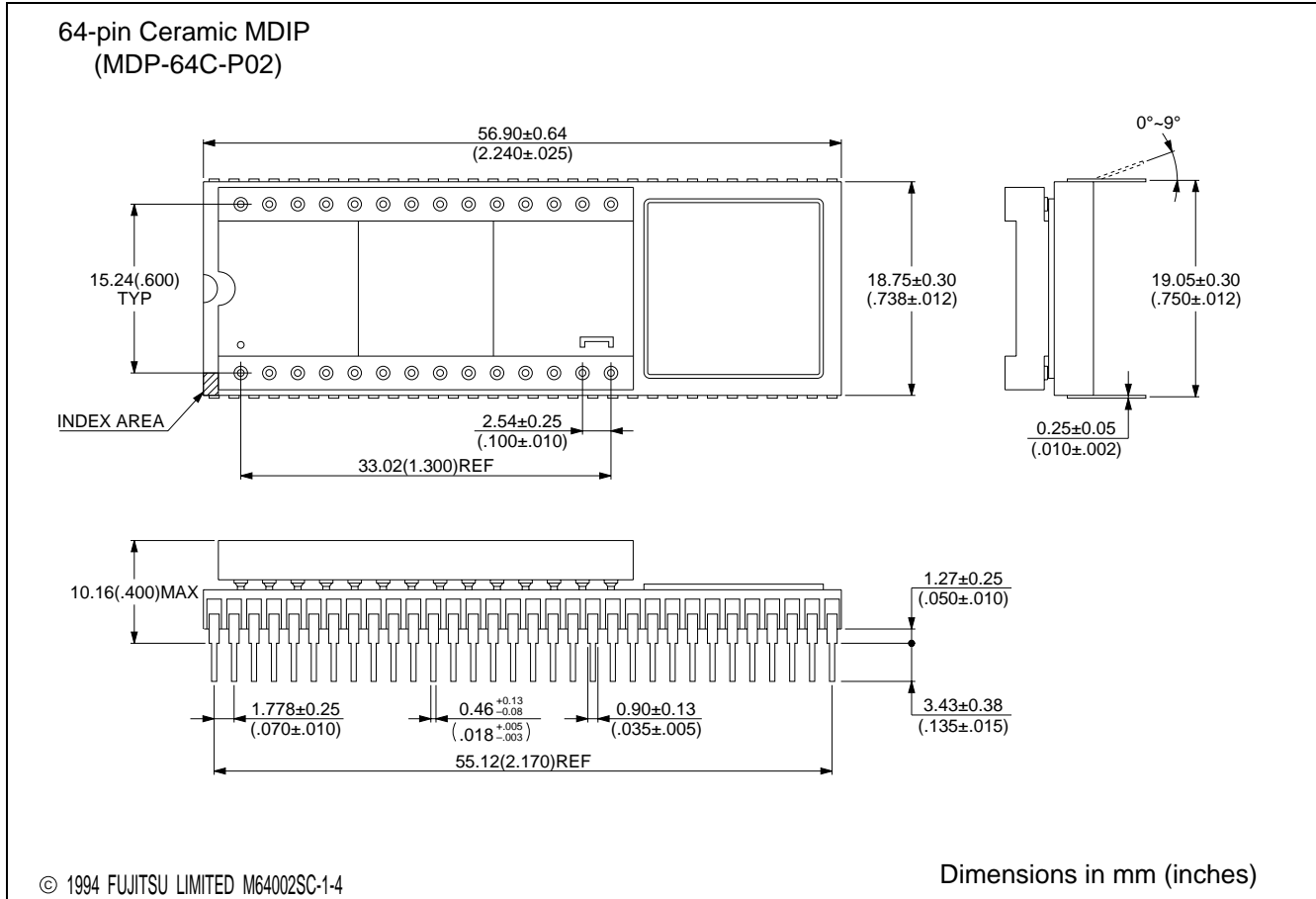

(Continued)

# MB89620 Series

(Continued)

64-pin Ceramic MQFP  
(MQP-64C-P01)

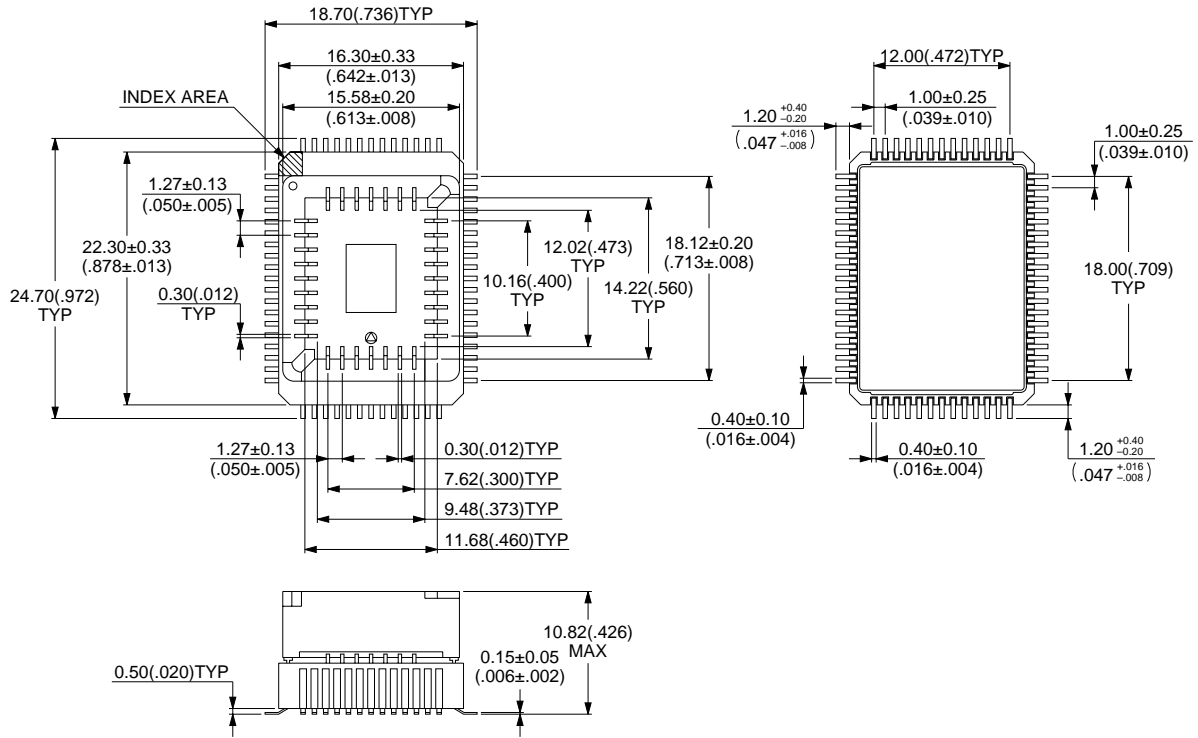

© 1994 FUJITSU LIMITED M64004SC-1-3

Dimensions in mm (inches)

## FUJITSU LIMITED

*For further information please contact:*

### **Japan**

FUJITSU LIMITED  
Corporate Global Business Support Division  
Electronic Devices  
Shinjuku Dai-Ichi Seimei Bldg. 7-1,  
Nishishinjuku 2-chome, Shinjuku-ku,  
Tokyo 163-0721, Japan  
Tel: +81-3-5322-3347  
Fax: +81-3-5322-3386

<http://edevice.fujitsu.com/>

### **North and South America**

FUJITSU MICROELECTRONICS, INC.  
3545 North First Street,  
San Jose, CA 95134-1804, U.S.A.  
Tel: +1-408-922-9000  
Fax: +1-408-922-9179

Customer Response Center  
*Mon. - Fri.: 7 am - 5 pm (PST)*  
Tel: +1-800-866-8608  
Fax: +1-408-922-9179

<http://www.fujitsumicro.com/>

### **Europe**

FUJITSU MICROELECTRONICS EUROPE GmbH  
Am Siebenstein 6-10,  
D-63303 Dreieich-Buchsschlag,  
Germany  
Tel: +49-6103-690-0  
Fax: +49-6103-690-122

<http://www.fujitsu-fme.com/>

### **Asia Pacific**

FUJITSU MICROELECTRONICS ASIA PTE. LTD.  
#05-08, 151 Lorong Chuan,  
New Tech Park,  
Singapore 556741  
Tel: +65-281-0770  
Fax: +65-281-0220

<http://www.fmap.com.sg/>

### **Korea**

FUJITSU MICROELECTRONICS KOREA LTD.  
1702 KOSMO TOWER, 1002 Daechi-Dong,  
Kangnam-Gu, Seoul 135-280  
Korea  
Tel: +82-2-3484-7100  
Fax: +82-2-3484-7111

F0012

© FUJITSU LIMITED Printed in Japan

All Rights Reserved.

The contents of this document are subject to change without notice. Customers are advised to consult with FUJITSU sales representatives before ordering.

The information and circuit diagrams in this document are presented as examples of semiconductor device applications, and are not intended to be incorporated in devices for actual use. Also, FUJITSU is unable to assume responsibility for infringement of any patent rights or other rights of third parties arising from the use of this information or circuit diagrams.

The contents of this document may not be reproduced or copied without the permission of FUJITSU LIMITED.

FUJITSU semiconductor devices are intended for use in standard applications (computers, office automation and other office equipments, industrial, communications, and measurement equipments, personal or household devices, etc.).

#### **CAUTION:**

Customers considering the use of our products in special applications where failure or abnormal operation may directly affect human lives or cause physical injury or property damage, or where extremely high levels of reliability are demanded (such as aerospace systems, atomic energy controls, sea floor repeaters, vehicle operating controls, medical devices for life support, etc.) are requested to consult with FUJITSU sales representatives before such use. The company will not be responsible for damages arising from such use without prior approval.

Any semiconductor devices have inherently a certain rate of failure. You must protect against injury, damage or loss from such failures by incorporating safety design measures into your facility and equipment such as redundancy, fire protection, and prevention of over-current levels and other abnormal operating conditions.

If any products described in this document represent goods or technologies subject to certain restrictions on export under the Foreign Exchange and Foreign Trade Control Law of Japan, the prior authorization by Japanese government should be required for export of those products from Japan.