



RF LDMOS Wideband Integrated Power Amplifiers

The MW6IC2240N wideband integrated circuit is designed with on-chip matching that makes it usable from 2110 to 2170 MHz. This multi-stage structure is rated for 26 to 32 Volt operation and covers all typical cellular base station modulation formats.

Final Application

- Typical 2-Carrier W-CDMA Performance: $V_{DD} = 28$ Volts, $I_{DQ1} = 210$ mA, $I_{DQ2} = 370$ mA, $P_{out} = 4.5$ Watts Avg., Full Frequency Band (2110-2170 MHz), Channel Bandwidth = 3.84 MHz, PAR = 8.5 dB @ 0.01% Probability on CCDF.
 Power Gain — 28 dB
 Power Added Efficiency — 15%
 IM3 @ 10 MHz Offset — -43 dBc in 3.84 MHz Bandwidth
 ACPR @ 5 MHz Offset — -46 dBc in 3.84 MHz Bandwidth

Driver Application

- Typical 2-Carrier W-CDMA Performance: $V_{DD} = 28$ Volts, $I_{DQ1} = 300$ mA, $I_{DQ2} = 320$ mA, $P_{out} = 25$ dBm, Full Frequency Band (2110-2170 MHz), Channel Bandwidth = 3.84 MHz, PAR = 8.5 dB @ 0.01% Probability on CCDF.
 Power Gain — 29 dB
 IM3 @ 10 MHz Offset — -59 dBc in 3.84 MHz Bandwidth
 ACPR @ 5 MHz Offset — -62 dBc in 3.84 MHz Bandwidth
- Capable of Handling 3:1 VSWR, @ 28 Vdc, 2170 MHz, 20 Watts CW Output Power
- Stable into a 3:1 VSWR. All Spurs Below -60 dBc @ 100 mW to 10 W CW P_{out} .
- Characterized with Series Equivalent Large-Signal Impedance Parameters and Common Source Scattering Parameters
- On-Chip Matching (50 Ohm Input, DC Blocked, >3 Ohm Output)
- Integrated Quiescent Current Temperature Compensation with Enable/Disable Function
- Integrated ESD Protection
- 200°C Capable Plastic Package
- N Suffix Indicates Lead-Free Terminations. RoHS Compliant.
- In Tape and Reel. R1 Suffix = 500 Units per 44 mm, 13 inch Reel

MW6IC2240NBR1
MW6IC2240GNBR1

2110-2170 MHz, 4.5 W AVG., 28 V
2 x W-CDMA
RF LDMOS WIDEBAND
INTEGRATED POWER AMPLIFIERS

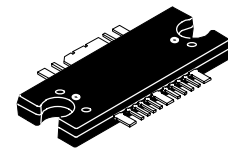

CASE 1329-09
TO-272 WB-16
PLASTIC
MW6IC2240NBR1

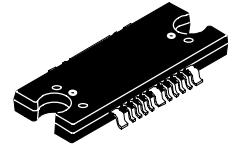

CASE 1329A-03
TO-272 WB-16 GULL
PLASTIC
MW6IC2240GNBR1

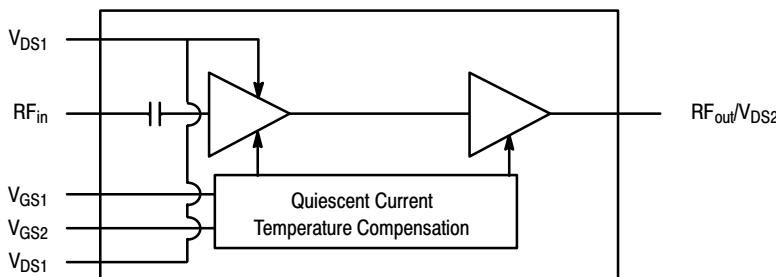
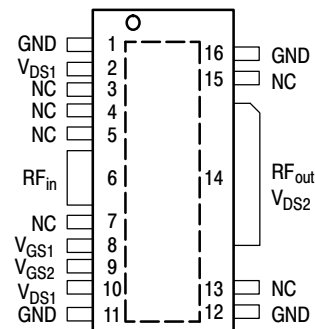

Figure 1. Functional Block Diagram



(Top View)

Note: Exposed backside flag is source terminal for transistors.

Figure 2. Pin Connections

Table 1. Maximum Ratings

Rating	Symbol	Value	Unit
Drain-Source Voltage	V_{DSS}	-0.5, +68	Vdc
Gate-Source Voltage	V_{GS}	-0.5, +6	Vdc
Storage Temperature Range	T_{stg}	-65 to +200	°C
Operating Junction Temperature	T_J	200	°C
Input Power	P_{in}	23	dBm

Table 2. Thermal Characteristics

Characteristic	Symbol	Value (1,2)	Unit
Thermal Resistance, Junction to Case	$R_{\theta JC}$		°C/W
W-CDMA Application ($P_{out} = 4.5$ W Avg.)	Stage 1, 28 Vdc, $I_{DQ} = 210$ mA Stage 2, 28 Vdc, $I_{DQ} = 370$ mA	1.8 1.0	
W-CDMA Application ($P_{out} = 40$ W CW)	Stage 1, 28 Vdc, $I_{DQ} = 110$ mA Stage 2, 28 Vdc, $I_{DQ} = 370$ mA	2.0 0.87	

Table 3. ESD Protection Characteristics

Test Methodology	Class
Human Body Model (per JESD22-A114)	1A (Minimum)
Machine Model (per EIA/JESD22-A115)	A (Minimum)
Charge Device Model (per JESD22-C101)	III (Minimum)

Table 4. Moisture Sensitivity Level

Test Methodology	Rating	Package Peak Temperature	Unit
Per JESD 22-A113, IPC/JEDEC J-STD-020	3	260	°C

Table 5. Electrical Characteristics ($T_C = 25^\circ\text{C}$ unless otherwise noted)

Characteristic	Symbol	Min	Typ	Max	Unit
----------------	--------	-----	-----	-----	------

Functional Tests (In Freescale Wideband 2110-2170 MHz Test Fixture, 50 ohm system) $V_{DD} = 28$ Vdc, $I_{DQ1} = 210$ mA, $I_{DQ2} = 370$ mA, $P_{out} = 4.5$ W Avg., $f_1 = 2112.5$ MHz, $f_2 = 2122.5$ MHz and $f_1 = 2157.5$ MHz, $f_2 = 2167.5$ MHz, 2-Carrier W-CDMA, 3.84 MHz Channel Bandwidth Carriers. ACPR measured in 3.84 MHz Channel Bandwidth @ ± 5 MHz Offset. IM3 measured in 3.84 MHz Channel Bandwidth @ ± 10 MHz Offset. PAR = 8.5 dB @ 0.01% Probability on CCDF.

Power Gain	G_{ps}	25.5	28	30	dB
Power Added Efficiency	PAE	13.7	15	—	%
Intermodulation Distortion	IM3	—	-43	-40	dBc
Adjacent Channel Power Ratio	ACPR	—	-46	-43	dBc
Input Return Loss	IRL	—	-15	-10	dB

1. MTF calculator available at <http://www.freescale.com/rf>. Select Tools/Software/Application Software/Calculators to access the MTF calculators by product.
2. Refer to AN1955, *Thermal Measurement Methodology of RF Power Amplifiers*. Go to <http://www.freescale.com/rf>. Select Documentation/Application Notes - AN1955.

(continued)

Table 5. Electrical Characteristics ($T_C = 25^\circ\text{C}$ unless otherwise noted) (continued)

Characteristic	Symbol	Min	Typ	Max	Unit
Typical Performances (In Freescale Test Fixture, 50 ohm system) $V_{DD} = 28\text{ Vdc}$, $I_{DQ1} = 210\text{ mA}$, $I_{DQ2} = 370\text{ mA}$, 2110 MHz < Frequency < 2170 MHz					
Video Bandwidth (Tone Spacing from 100 kHz to VBW) $\Delta\text{IMD3} = \text{IMD3 @ VBW frequency} - \text{IMD3 @ 100 kHz} < 1\text{ dBc}$ (both sidebands)	VBW	—	30	—	MHz
Quiescent Current Accuracy over Temperature with 18 k Ω Gate Feed Resistors (-10 to 85 $^\circ\text{C}$) (1)	ΔI_{QT}	—	± 5	—	%
Gain Flatness in 30 MHz Bandwidth @ $P_{out} = 1\text{ W CW}$	G_F	—	0.2	—	dB
Deviation from Linear Phase in 30 MHz Bandwidth @ $P_{out} = 1\text{ W CW}$	Φ	—	± 1	—	$^\circ$
Delay @ $P_{out} = 1\text{ W CW}$ Including Output Matching	Delay	—	2.8	—	ns
Part-to-Part Phase Variation @ $P_{out} = 1\text{ W CW}$	$\Delta\Phi$	—	± 9	—	$^\circ$

Table 6. Electrical Characteristics ($T_C = 25^\circ\text{C}$ unless otherwise noted)

Characteristic	Symbol	Min	Typ	Max	Unit
Typical Performances (In Freescale Test Fixture, 50 ohm system) $V_{DD} = 28\text{ Vdc}$, $I_{DQ1} = 110\text{ mA}$, $I_{DQ2} = 370\text{ mA}$, 2110 MHz < Frequency < 2170 MHz					
Saturated Pulsed Output Power (8 μsec (on), 1 msec (off))	P_{sat}	—	60	—	W

1. Refer to AN1977, *Quiescent Current Thermal Tracking Circuit in the RF Integrated Circuit Family*. Go to <http://www.freescale.com/rf>. Select Documentation/ApplicationNotes - AN1977.

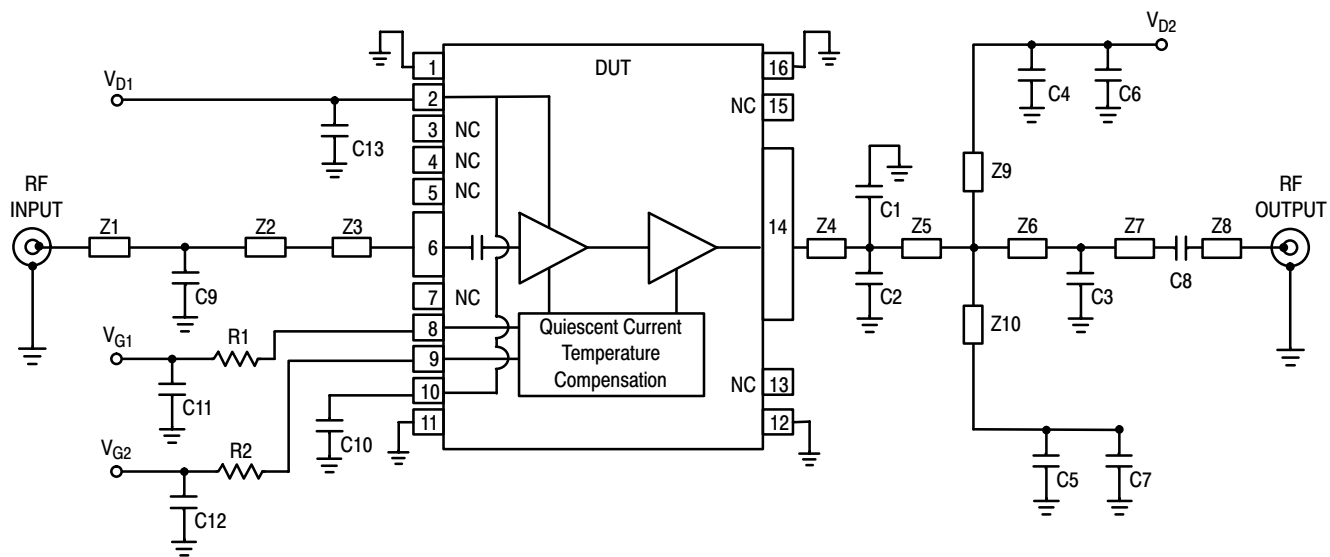

Z1* 1.73" x 0.090" Microstrip
 Z2* 0.47" x 0.090" Microstrip
 Z3 0.13" x 0.040" Microstrip
 Z4* 0.22" x 0.315" Microstrip
 Z5* 0.34" x 0.315" Microstrip
 Z6* 0.34" x 0.090" Microstrip

Z7* 0.94" x 0.090" Microstrip
 Z8 0.34" x 0.090" Microstrip
 Z9, Z10 1.00" x 0.080" Microstrip
 PCB Taconic TLX8-0300, 0.030", $\epsilon_r = 2.55$
 * Variable for tuning

Figure 3. MW6IC2240NBR1(GNBR1) Test Circuit Schematic

Table 7. MW6IC2240NBR1(GNBR1) Test Circuit Component Designations and Values

Part	Description	Part Number	Manufacturer
C1, C2	1.5 pF 100B Chip Capacitors	100B1R5BW	ATC
C3	1.8 pF 100B Chip Capacitor	100B1R8BW	ATC
C4, C5	6.8 pF 100B Chip Capacitors	100B6R8CW	ATC
C6, C7, C10, C11, C12, C13	4.7 μ F Chip Capacitors (1812)	C4532X5R1H475MT	TDK
C8	8.2 pF 100B Chip Capacitor	100B8R2CW	ATC
C9	0.5 pF 100B Chip Capacitor	100B0R5BW	ATC
R1	18 k Ω , 1/4 W Chip Resistor (1206)		
R2	8.2 k Ω , 1/4 W Chip Resistor (1206)		

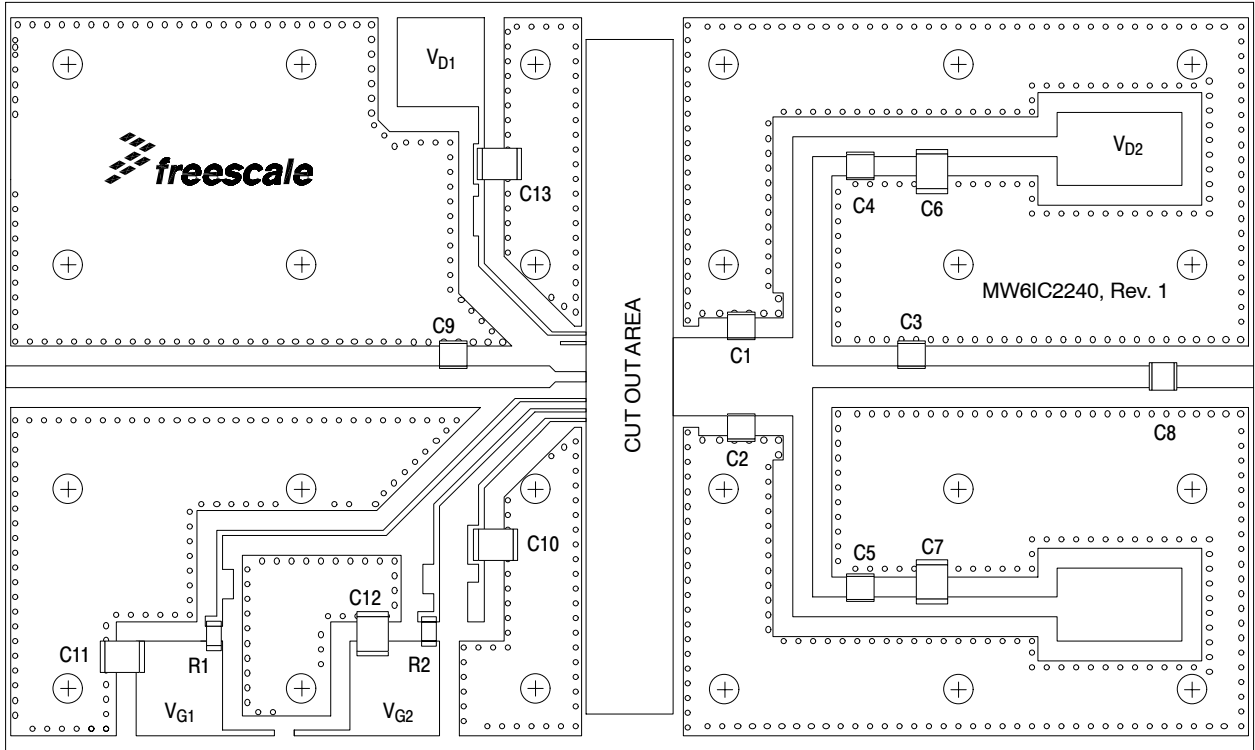
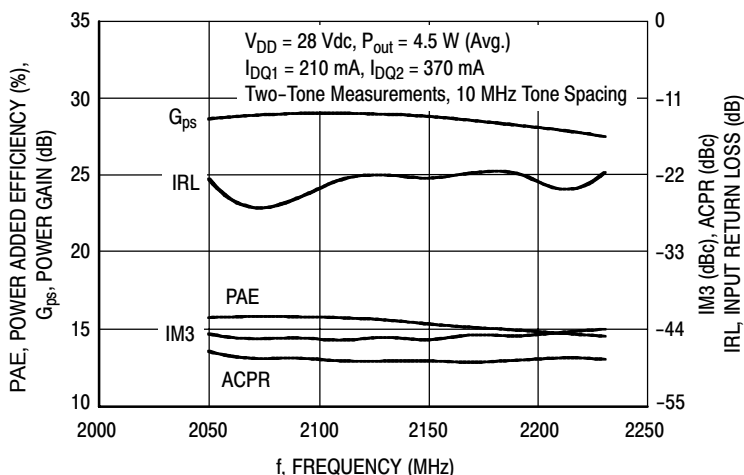
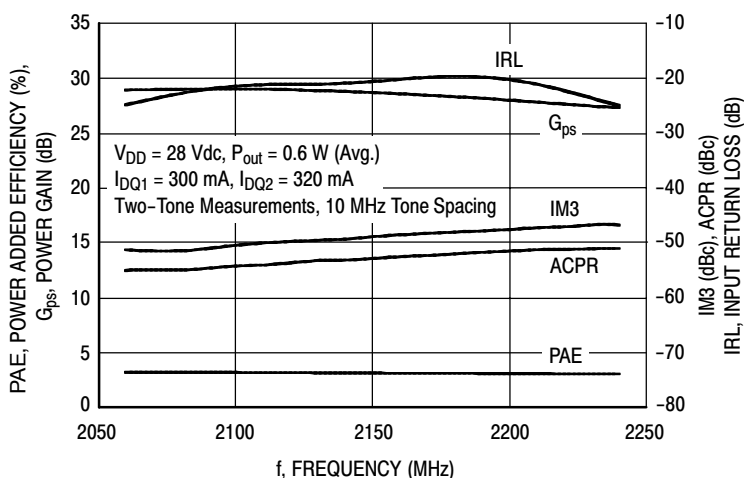

Figure 4. MW6IC2240NBR1(GNBR1) Test Circuit Component Layout

TYPICAL CHARACTERISTICS



**Figure 5. 2-Carrier W-CDMA Wideband Performance
@ $P_{out} = 4.5$ Watts Avg.**



**Figure 6. 2-Carrier W-CDMA Wideband Performance
@ $P_{out} = 0.6$ Watts Avg.**

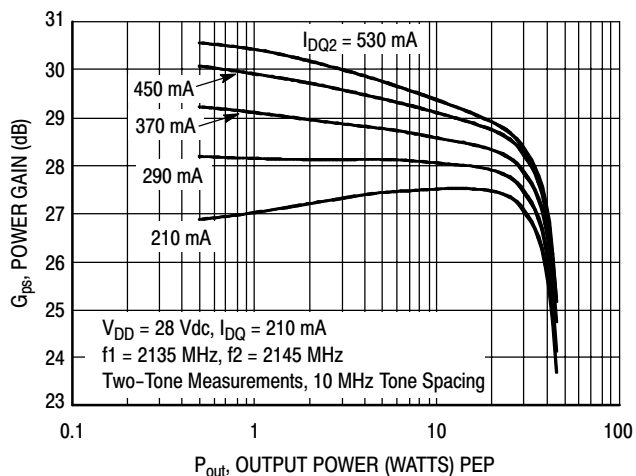

**Figure 7. Two-Tone Power Gain versus
Output Power**

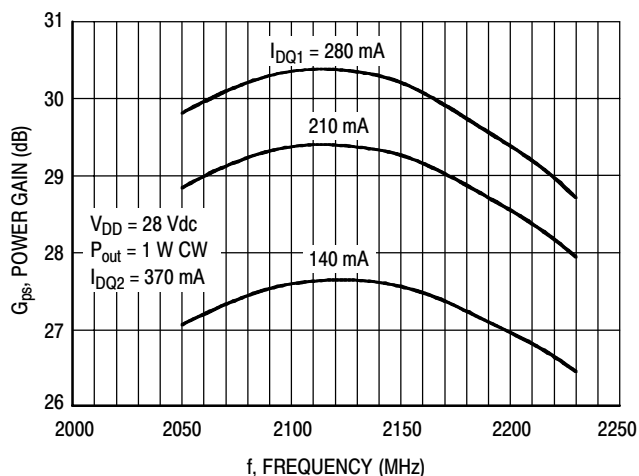

Figure 8. Frequency Response versus Current

TYPICAL CHARACTERISTICS

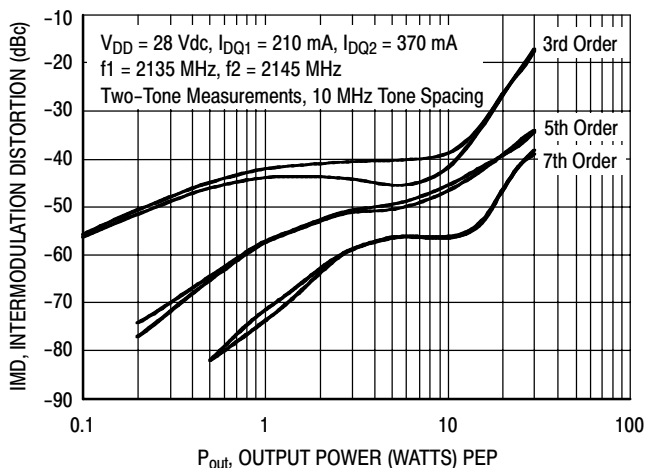

Figure 9. Intermodulation Distortion Products versus Output Power

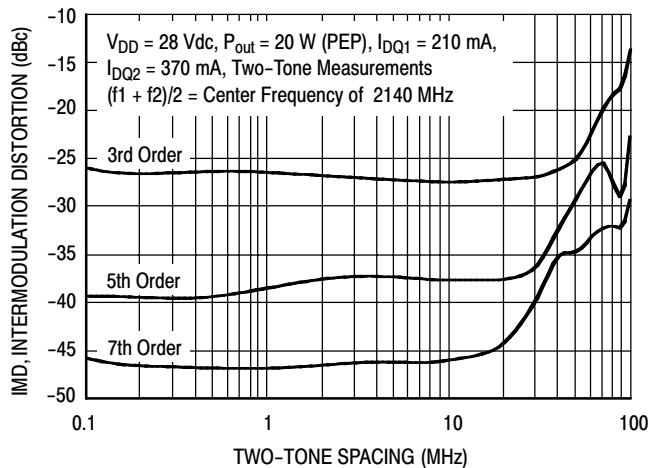

Figure 10. Intermodulation Distortion Products versus Tone Spacing

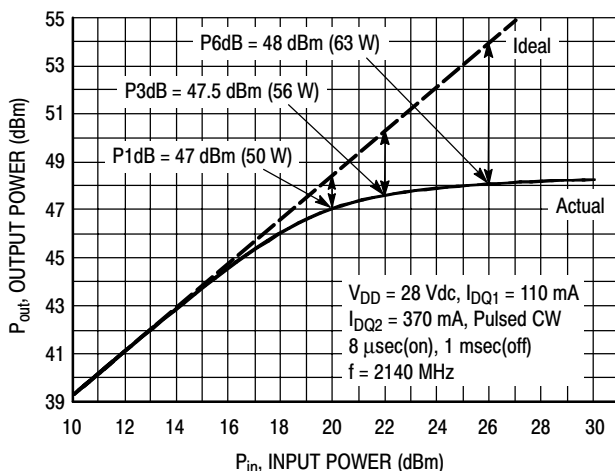

Figure 11. Pulse CW Output Power versus Input Power

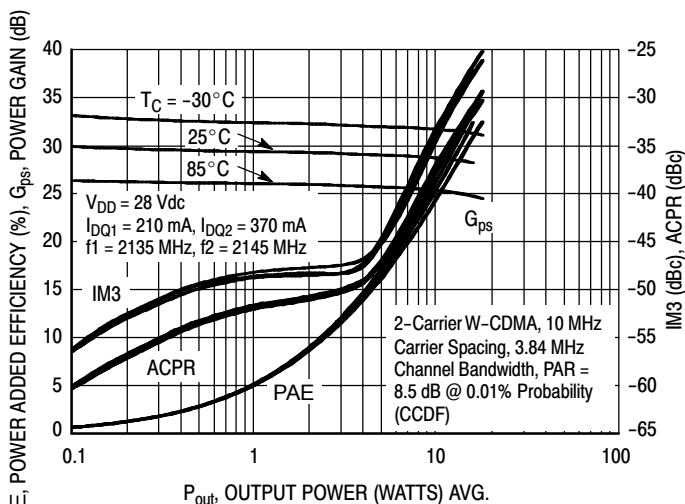

Figure 12. 2-Carrier W-CDMA ACPR, IM3, Power Gain and Power Added Efficiency versus Output Power

TYPICAL CHARACTERISTICS

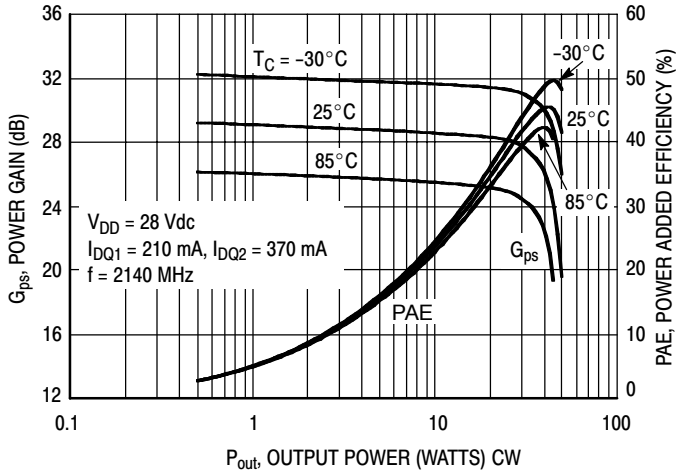

Figure 13. Power Gain and Power Added Efficiency versus Output Power

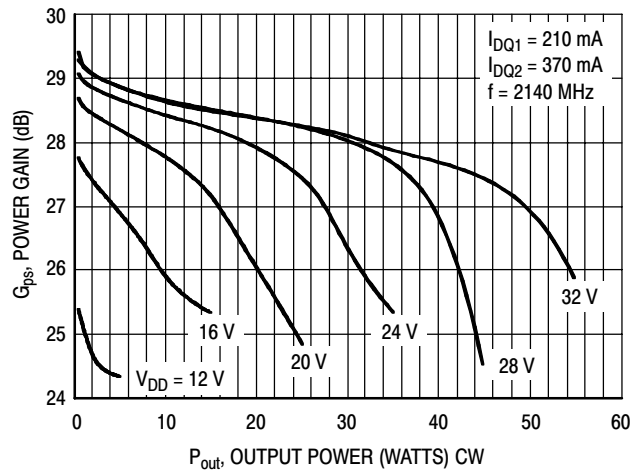
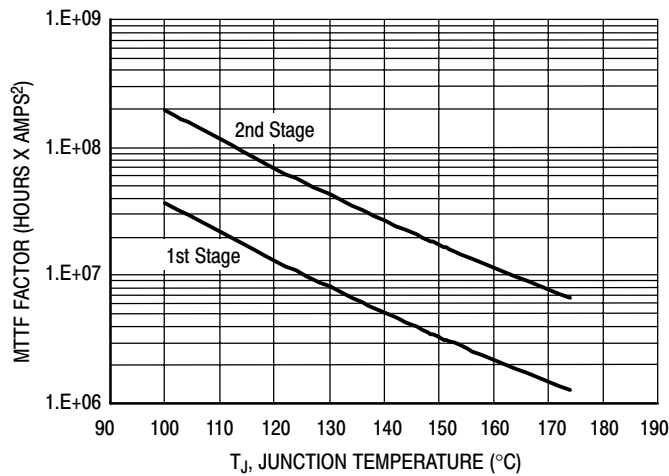
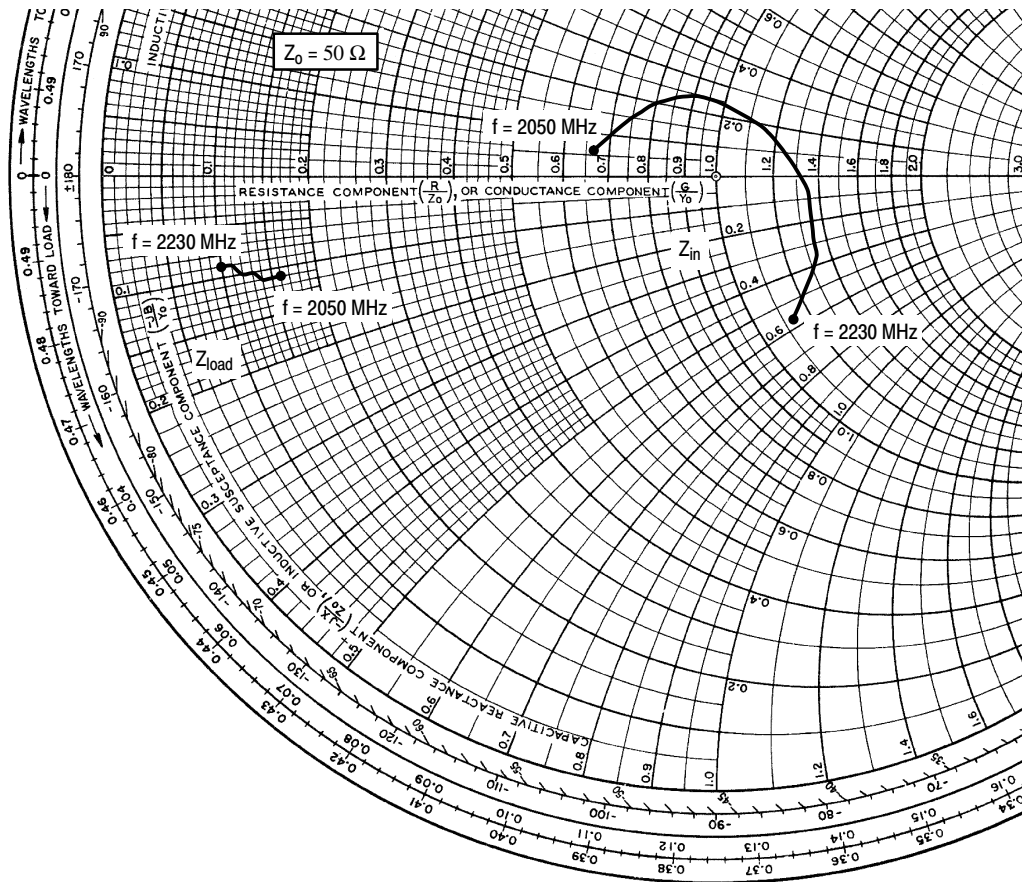

Figure 14. Power Gain versus Output Power



This above graph displays calculated MTTF in hours x ampere² drain current. Life tests at elevated temperatures have correlated to better than $\pm 10\%$ of the theoretical prediction for metal failure. Divide MTTF factor by I_D^2 for MTTF in a particular application.

Figure 15. MTTF Factor versus Junction Temperature



$V_{DD} = 28 \text{ Vdc}$, $I_{DQ1} = 210 \text{ mA}$, $I_{DQ2} = 370 \text{ mA}$, $P_{out} = 4.5 \text{ W Avg.}$

f MHz	Z_{in} Ω	Z_{load} Ω
2050	$33.723 + j3.048$	$7.971 - j5.705$
2080	$38.052 + j8.201$	$7.559 - j5.532$
2110	$45.972 + j12.306$	$7.117 - j5.345$
2140	$59.075 + 9.272$	$6.642 - j5.119$
2170	$68.368 - j3.227$	$6.132 - j4.891$
2200	$67.177 - j19.071$	$5.626 - j4.619$
2230	$58.213 - j28.879$	$5.118 - j4.305$

Z_{in} = Device input impedance as measured from gate to ground.

Z_{load} = Test circuit impedance as measured from drain to ground.

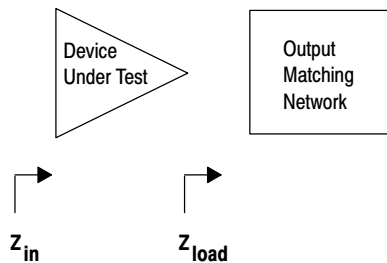

Figure 16. Series Equivalent Input and Load Impedance

MW6IC2240NBR1 MW6IC2240GNBR1

Table 8. Common Source Scattering Parameters ($V_{DD} = 28\text{ V}$, 50 ohm system)

$I_{DQ1} = 210\text{ mA}$, $I_{DQ2} = 370\text{ mA}$

f MHz	S ₁₁		S ₂₁		S ₁₂		S ₂₂	
	S ₁₁	∠φ	S ₂₁	∠φ	S ₁₂	∠φ	S ₂₂	∠φ
1000	0.788	131.360	0.0013	63.602	0.0020	25.353	0.9940	172.664
1200	0.713	113.326	0.0012	42.219	0.0094	10.742	0.9910	169.954
1400	0.584	86.885	0.0007	55.210	0.1180	-39.325	0.9850	166.452
1600	0.389	41.593	0.0006	117.726	0.6690	-92.822	0.9780	161.752
1800	0.239	-54.753	0.0022	122.409	4.9300	-164.584	0.9310	152.388
2000	0.221	-162.180	0.0036	118.178	21.396	49.432	0.6120	151.441
2200	0.216	-38.746	0.0057	68.626	19.739	-105.946	0.7530	-177.800
2400	0.467	-113.440	0.0043	64.758	7.8281	166.887	0.9010	171.868
2600	0.539	-153.020	0.0044	48.498	3.8868	113.310	0.9350	167.252
2800	0.635	-171.630	0.0044	52.829	2.4331	69.460	0.9480	164.137
3000	0.716	169.263	0.0049	56.398	1.6119	29.135	0.9570	161.593

NOTES

NOTES

NOTES

PACKAGE DIMENSIONS

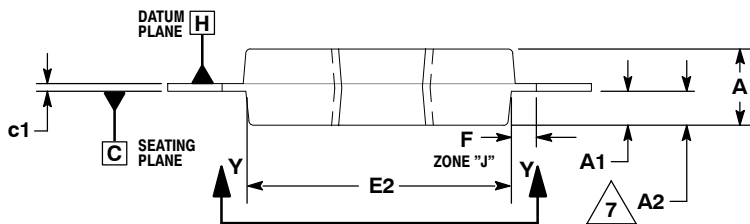
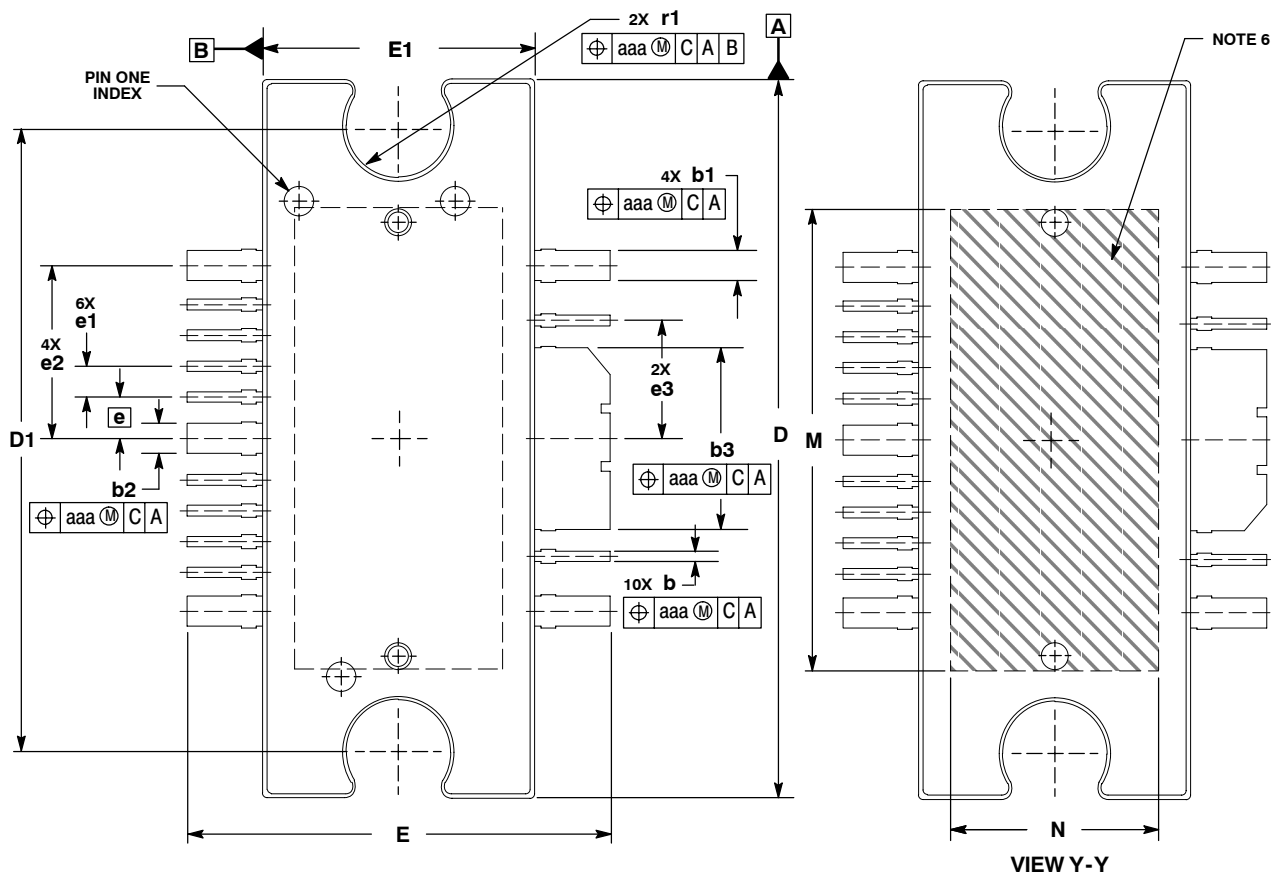

- NOTES:
1. CONTROLLING DIMENSION: INCH.
 2. INTERPRET DIMENSIONS AND TOLERANCES PER ASME Y14.5M-1994.
 3. DATUM PLANE -H- IS LOCATED AT TOP OF LEAD AND IS COINCIDENT WITH THE LEAD WHERE THE LEAD EXITS THE PLASTIC BODY AT THE TOP OF THE PARTING LINE.
 4. DIMENSIONS "D" AND "E1" DO NOT INCLUDE MOLD PROTRUSION. ALLOWABLE PROTRUSION IS .006 (0.15) PER SIDE. DIMENSIONS "D" AND "E1" DO INCLUDE MOLD MISMATCH AND ARE DETERMINED AT DATUM PLANE -H-.
 5. DIMENSIONS "b", "b1", "b2" AND "b3" DO NOT INCLUDE DAMBAR PROTRUSION. ALLOWABLE DAMBAR PROTRUSION SHALL BE .005 (0.13) TOTAL IN EXCESS OF THE "b", "b1", "b2" AND "b3" DIMENSIONS AT MAXIMUM MATERIAL CONDITION.
 6. HATCHING REPRESENTS THE EXPOSED AREA OF THE HEAT SLUG.
 7. DIM A2 APPLIES WITHIN ZONE "J" ONLY.

DIM	INCHES		MILLIMETERS	
	MIN	MAX	MIN	MAX
A	.100	.104	2.54	2.64
A1	.038	.044	0.96	1.12
A2	.040	.042	1.02	1.07
D	.928	.932	23.57	23.67
D1	.810 BSC		20.57 BSC	
E	.551	.559	14.00	14.20
E1	.353	.357	8.97	9.07
E2	.346	.350	8.79	8.89
F	.025 BSC		0.64 BSC	
M	.600	---	15.24	---
N	.270	---	6.86	---
b	.011	.017	0.28	0.43
b1	.037	.043	0.94	1.09
b2	.037	.043	0.94	1.09
b3	.225	.231	5.72	5.87
c1	.007	.011	.18	.28
e	.054 BSC		1.37 BSC	
e1	.040 BSC		1.02 BSC	
e2	.224 BSC		5.69 BSC	
e3	.150 BSC		3.81 BSC	
r1	.063	.068	1.6	1.73
aaa	.004		.10	

**CASE 1329-09
ISSUE K
TO-272 WB-16
PLASTIC
MW6IC2240NBR1**

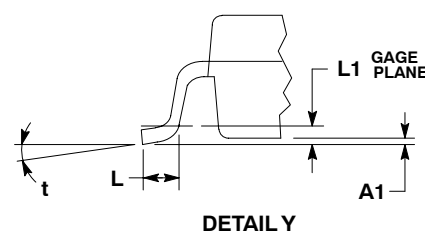
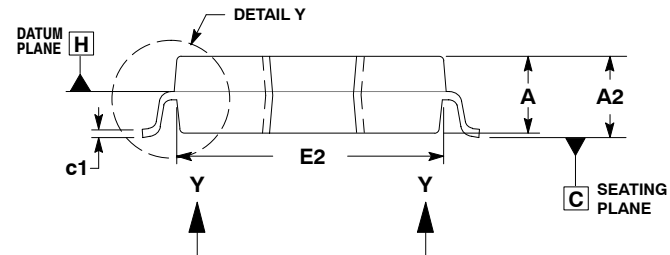
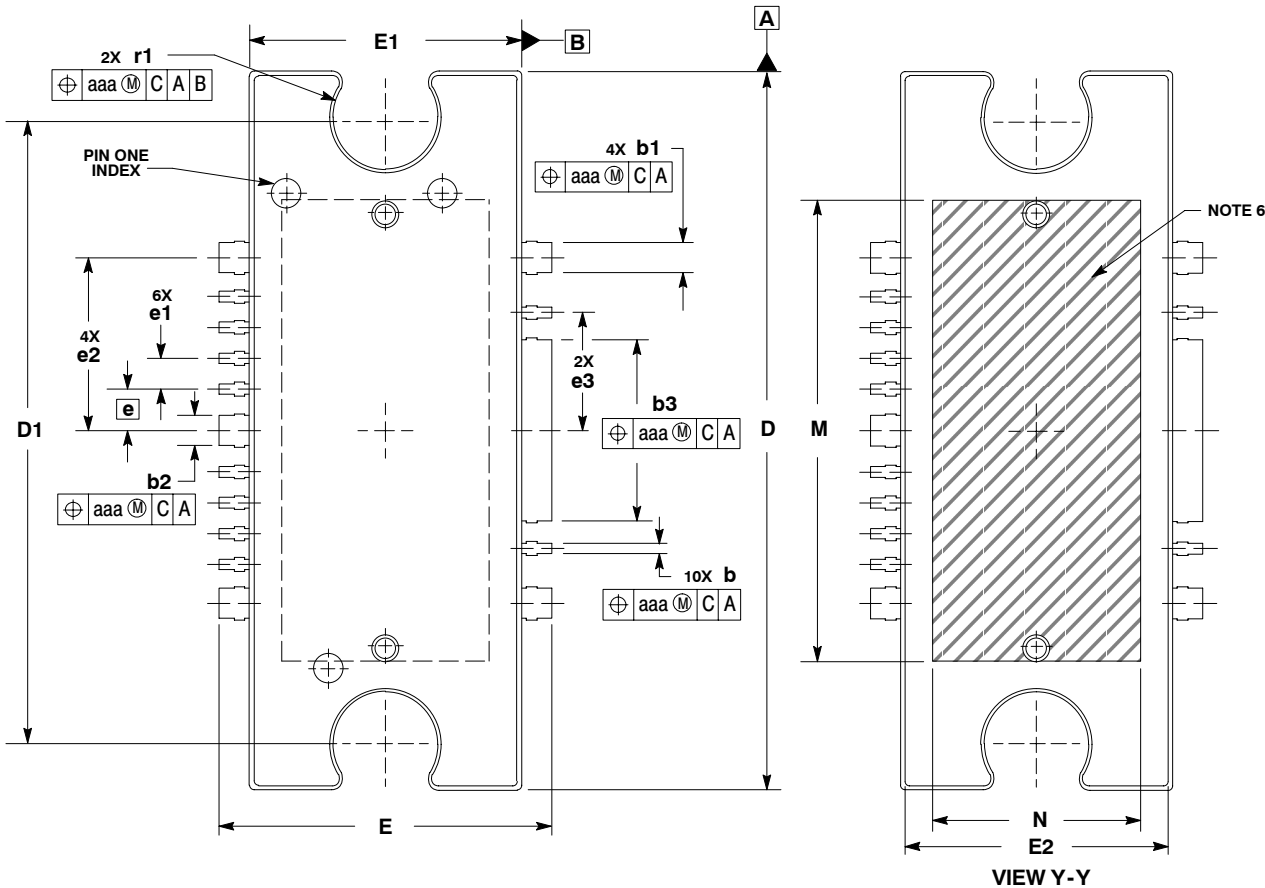

- NOTES:
1. CONTROLLING DIMENSION: INCH.
 2. INTERPRET DIMENSIONS AND TOLERANCES PER ASME Y14.5M-1994.
 3. DATUM PLANE -H- IS LOCATED AT TOP OF LEAD AND IS COINCIDENT WITH THE LEAD WHERE THE LEAD EXITS THE PLASTIC BODY AT THE TOP OF THE PARTING LINE.
 4. DIMENSIONS "D" AND "E1" DO NOT INCLUDE MOLD PROTRUSION. ALLOWABLE PROTRUSION IS .006 (0.15) PER SIDE. DIMENSIONS "D" AND "E1" DO INCLUDE MOLD MISMATCH AND ARE DETERMINED AT DATUM PLANE -H-.
 5. DIMENSIONS "b", "b1", "b2" AND "b3" DO NOT INCLUDE DAMBAR PROTRUSION. ALLOWABLE DAMBAR PROTRUSION SHALL BE .005 (0.13) TOTAL IN EXCESS OF THE "b", "b1", "b2" AND "b3" DIMENSIONS AT MAXIMUM MATERIAL CONDITION.
 6. HATCHING REPRESENTS THE EXPOSED AREA OF THE HEAT SINK.

DIM	INCHES		MILLIMETERS	
	MIN	MAX	MIN	MAX
A	.100	.104	2.54	2.64
A1	.001	.004	0.02	0.10
A2	.099	.110	2.51	2.79
D	.928	.932	23.57	23.67
D1	.810 BSC		20.57 BSC	
E	.429	.437	10.90	11.10
E1	.353	.357	8.97	9.07
E2	.346	.350	8.79	8.89
L	.018	.024	4.90	5.06
L1	.01 BSC		0.25 BSC	
M	.600	---	15.24	---
N	.270	---	6.86	---
b	.011	.017	0.28	0.43
b1	.037	.043	0.94	1.09
b2	.037	.043	0.94	1.09
b3	.225	.231	5.72	5.87
c1	.007	.011	.18	.28
e	.054 BSC		1.37 BSC	
e1	.040 BSC		1.02 BSC	
e2	.224 BSC		5.69 BSC	
e3	.150 BSC		3.81 BSC	
r1	.063	.068	1.6	1.73
t	2°	8°	2°	8°
aaa	.004		.10	

**CASE 1329A-03
ISSUE D
TO-272 WB-16 GULL
PLASTIC
MW6IC2240GNBR1**

MW6IC2240NBR1 MW6IC2240GNBR1

How to Reach Us:

Home Page:

www.freescale.com

E-mail:

support@freescale.com

USA/Europe or Locations Not Listed:

Freescale Semiconductor
Technical Information Center, CH370
1300 N. Alma School Road
Chandler, Arizona 85224
+1-800-521-6274 or +1-480-768-2130
support@freescale.com

Europe, Middle East, and Africa:

Freescale Halbleiter Deutschland GmbH
Technical Information Center
Schatzbogen 7
81829 Muenchen, Germany
+44 1296 380 456 (English)
+46 8 52200080 (English)
+49 89 92103 559 (German)
+33 1 69 35 48 48 (French)
support@freescale.com

Japan:

Freescale Semiconductor Japan Ltd.
Headquarters
ARCO Tower 15F
1-8-1, Shimo-Meguro, Meguro-ku,
Tokyo 153-0064
Japan
0120 191014 or +81 3 5437 9125
support.japan@freescale.com

Asia/Pacific:

Freescale Semiconductor Hong Kong Ltd.
Technical Information Center
2 Dai King Street
Tai Po Industrial Estate
Tai Po, N.T., Hong Kong
+800 2666 8080
support.asia@freescale.com

For Literature Requests Only:

Freescale Semiconductor Literature Distribution Center
P.O. Box 5405
Denver, Colorado 80217
1-800-441-2447 or 303-675-2140
Fax: 303-675-2150
LDCForFreescaleSemiconductor@hibbertgroup.com

Information in this document is provided solely to enable system and software implementers to use Freescale Semiconductor products. There are no express or implied copyright licenses granted hereunder to design or fabricate any integrated circuits or integrated circuits based on the information in this document.

Freescale Semiconductor reserves the right to make changes without further notice to any products herein. Freescale Semiconductor makes no warranty, representation or guarantee regarding the suitability of its products for any particular purpose, nor does Freescale Semiconductor assume any liability arising out of the application or use of any product or circuit, and specifically disclaims any and all liability, including without limitation consequential or incidental damages. "Typical" parameters that may be provided in Freescale Semiconductor data sheets and/or specifications can and do vary in different applications and actual performance may vary over time. All operating parameters, including "Typicals", must be validated for each customer application by customer's technical experts. Freescale Semiconductor does not convey any license under its patent rights nor the rights of others. Freescale Semiconductor products are not designed, intended, or authorized for use as components in systems intended for surgical implant into the body, or other applications intended to support or sustain life, or for any other application in which the failure of the Freescale Semiconductor product could create a situation where personal injury or death may occur. Should Buyer purchase or use Freescale Semiconductor products for any such unintended or unauthorized application, Buyer shall indemnify and hold Freescale Semiconductor and its officers, employees, subsidiaries, affiliates, and distributors harmless against all claims, costs, damages, and expenses, and reasonable attorney fees arising out of, directly or indirectly, any claim of personal injury or death associated with such unintended or unauthorized use, even if such claim alleges that Freescale Semiconductor was negligent regarding the design or manufacture of the part.

Freescale™ and the Freescale logo are trademarks of Freescale Semiconductor, Inc. All other product or service names are the property of their respective owners.
© Freescale Semiconductor, Inc. 2006. All rights reserved.

RoHS-compliant and/or Pb-free versions of Freescale products have the functionality and electrical characteristics of their non-RoHS-compliant and/or non-Pb-free counterparts. For further information, see <http://www.freescale.com> or contact your Freescale sales representative.

For information on Freescale's Environmental Products program, go to <http://www.freescale.com/epp>.

