

DIAC

Features

1. V_{BO} : 32V
2. Breakover voltage range: 28 to 36V

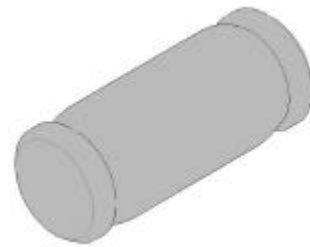

Applications

Functioning as a trigger diode with a fixed voltage reference, the LLDB3 can be used in conjunction with triacs for simplified gate control circuits or as a starting element in fluorescent lamp ballasts.

Absolute Maximum Ratings

(Limiting values)

Parameter	Symbol	Value	Unit
Repetitive peak on-state current ($t_p=20\mu s$ $F=120$ Hz)	I_{TRM}	2	A
Operating junction temperature range	T_j	-40 ~ +125	?
Storage temperature range	T_{stg}	-40 ~ +125	?

Electrical Characteristics

($T_j=25^\circ\text{C}$ unless otherwise specified)

Parameter	Symbol	Test Conditions		Value	Unit
Breakover voltage*	V_{BO}	$C=22\text{nF}^{**}$	MIN.	28	V
			TYP.	32	
			MAX.	36	
Breakover voltage symmetry	$ V_{BO1}-V_{BO2} $	$C=22\text{nF}^{**}$	MAX.	± 3	V
Dynamic breakover voltage*	? V	V_{BO} and V_F at 10mA	MIN.	5	V
Output voltage*	V_O	see diagram 2($R=200\ \Omega$)	MIN.	5	V
Breakover current*	I_{BO}	$C=22\text{nF}^{**}$	MAX.	50	μA
Rise time*	t_r	see diagram 3	MAX.	2	μs
Leakage current*	I_R	$V_R=0.5V_{BO}$ max	MAX.	10	μA

*Applicable to both forward and reverse directions.

**Connected in parallel to the device.

Diagram 1: Voltage - current characteristic curve.

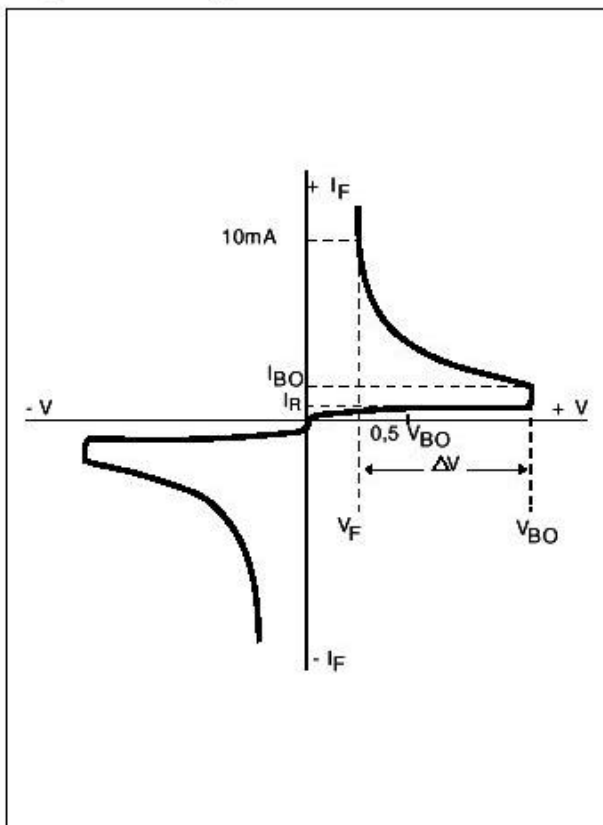

Diagram 2: Test circuit.

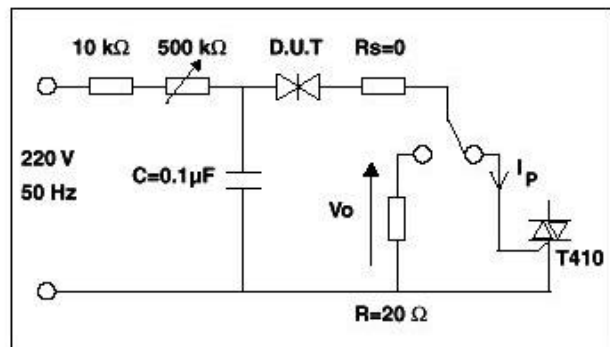

Diagram 3: Rise time measurement.

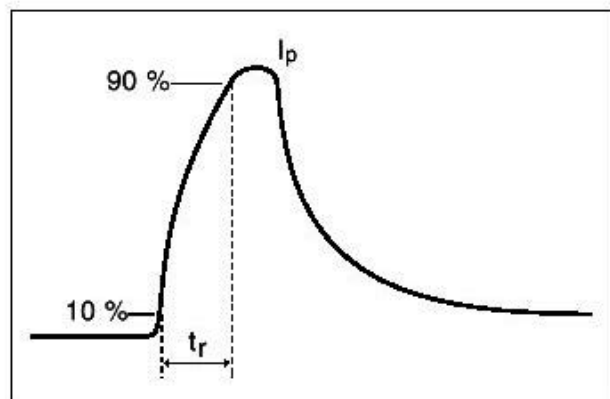

Fig. 1: Relative variation of VBO versus junction temperature (typical values)

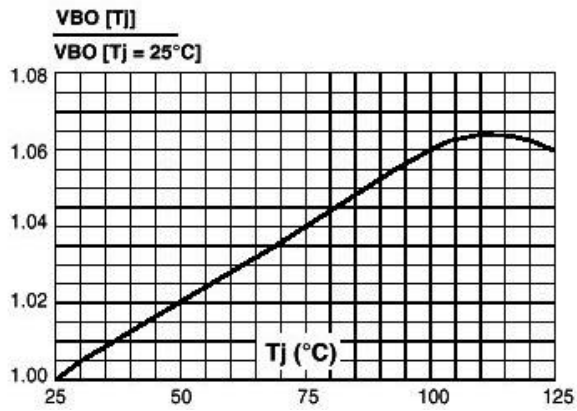

Fig. 2: Repetitive peak pulse current versus pulse duration (maximum values).

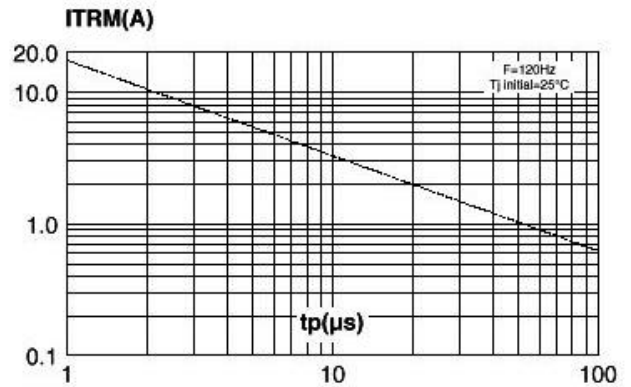
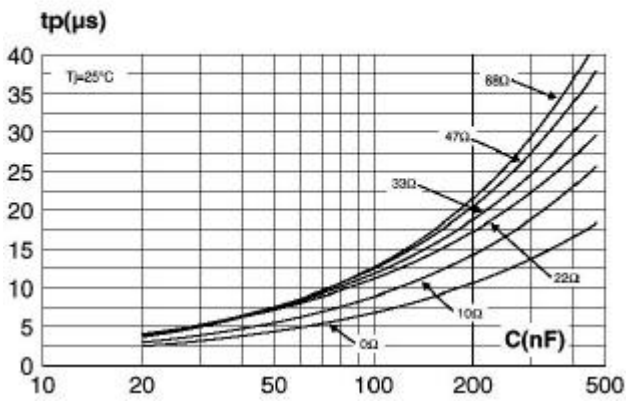
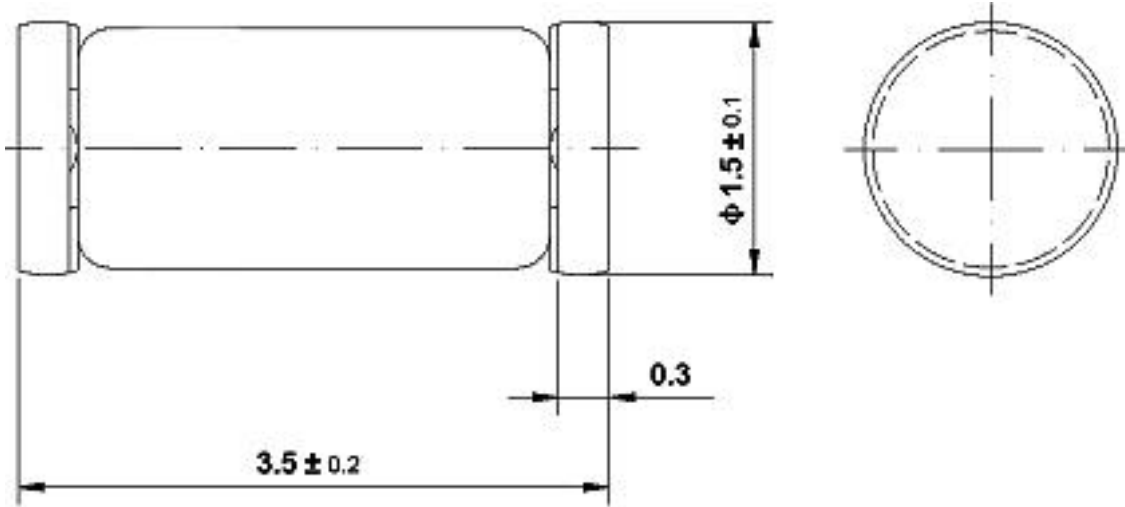

Fig. 3: Time duration while current pulse is higher 50mA versus C and Rs (typical values).



Dimensions in mm



Glass Case
Mini Melf / SOD 80
JEDEC DO 213 AA