

MM74HC02 Quad 2-Input NOR Gate

General Description

The MM74HC02 NOR gates utilize advanced silicon-gate CMOS technology to achieve operating speeds similar to LS-TTL gates with the low power consumption of standard CMOS integrated circuits. All gates have buffered outputs, providing high noise immunity and the ability to drive 10 LS-TTL loads. The 74HC logic family is functionally as well as pin-out compatible with the standard 74LS logic family. All inputs are protected from damage due to static discharge by internal diode clamps to V_{CC} and ground.

Features

- Typical propagation delay: 8 ns
- Wide power supply range: 2–6V
- Low quiescent supply current: 20 μ A maximum (74HC Series)
- Low input current: 1 μ A maximum
- High output current: 4 mA minimum

Ordering Code:

Order Number	Package Number	Package Description
MM74HC02M	M14A	14-Lead Small Outline Integrated Circuit (SOIC), JEDEC MS-120, 0.150" Narrow Body
MM74HC02SJ	M14D	14-Lead Small Outline Package (SOP), EIAJ TYPE II, 5.3mm Wide
MM74HC02MTC	MTC14	14-Lead Thin Shrink Small Outline Package (TSSOP), JEDEC MO-153, 4.4mm Wide
MM74HC02N	N14A	14-Lead Plastic Dual-In-Line Package (PDIP), JEDEC MS-001, 0.300" Wide

Devices also available in Tape and Reel. Specify by appending the suffix letter "X" to the ordering code. (Tape and Reel not available in N14A.)

Connection Diagram

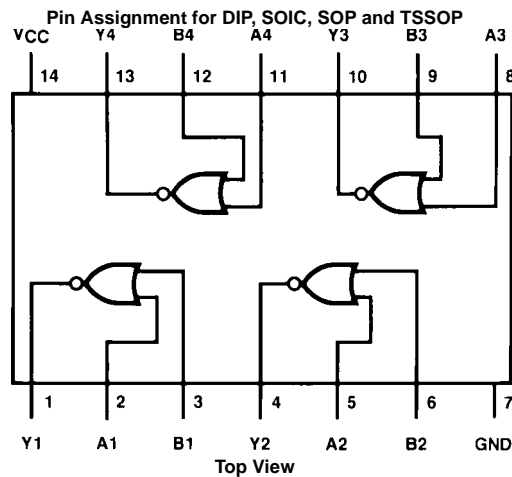

Logic Diagram



Absolute Maximum Ratings (Note 1)

(Note 2)

Supply Voltage (V_{CC})	-0.5 to +7.0V
DC Input Voltage (V_{IN})	-1.5 to $V_{CC} + 1.5V$
DC Output Voltage (V_{OUT})	-0.5 to $V_{CC} + 0.5V$
Clamp Diode Current (I_{IK}, I_{OK})	± 20 mA
DC Output Current, per pin (I_{OUT})	± 25 mA
DC V_{CC} or GND Current, per pin (I_{CC})	± 50 mA
Storage Temperature Range (T_{STG})	-65°C to +150°C
Power Dissipation (P_D)	
(Note 3)	600 mW
S.O. Package only	500 mW
Lead Temperature (T_L)	
(Soldering 10 seconds)	260°C

Recommended Operating Conditions

	Min	Max	Units
Supply Voltage (V_{CC})	2	6	V
DC Input or Output Voltage (V_{IN}, V_{OUT})	0	V_{CC}	V
Operating Temperature Range (T_A)	-40	+125	°C
Input Rise or Fall Times (t_r, t_f)			
$V_{CC} = 2.0V$		1000	ns
$V_{CC} = 4.5V$		500	ns
$V_{CC} = 6.0V$		400	ns

Note 1: Absolute Maximum Ratings are those values beyond which damage to the device may occur.

Note 2: Unless otherwise specified all voltages are referenced to ground.

Note 3: Power Dissipation temperature derating — plastic "N" package: -12 mW/°C from 65°C to 85°C.

DC Electrical Characteristics (Note 4)

Symbol	Parameter	Conditions	V_{CC}	$T_A = 25^\circ\text{C}$			Units	
				Typ	Guaranteed Limits			
V_{IH}	Minimum HIGH Level Input Voltage		2.0V		1.5	1.5	V	
			4.5V		3.15	3.15	V	
			6.0V		4.2	4.2	V	
V_{IL}	Maximum LOW Level Input Voltage		2.0V		0.5	0.5	V	
			4.5V		1.35	1.35	V	
			6.0V		1.8	1.8	V	
V_{OH}	Minimum HIGH Level Output Voltage	$V_{IN} = V_{IL}$ $ I_{OUT} \leq 20 \mu\text{A}$	2.0V	2.0	1.9	1.9	V	
			4.5V	4.5	4.4	4.4	V	
			6.0V	6.0	5.9	5.9	V	
		$V_{IN} = V_{IL}$ $ I_{OUT} \leq 4.0 \text{ mA}$ $ I_{OUT} \leq 5.2 \text{ mA}$	4.5V	4.2	3.98	3.84	3.7	V
			6.0V	5.7	5.48	5.34	5.2	V
V_{OL}	Maximum LOW Level Output Voltage	$V_{IN} = V_{IH}$ or V_{IL} $ I_{OUT} \leq 20 \mu\text{A}$	2.0V	0	0.1	0.1	0.1	V
			4.5V	0	0.1	0.1	0.1	V
			6.0V	0	0.1	0.1	0.1	V
		$V_{IN} = V_{IH}$ or V_{IL} $ I_{OUT} \leq 4.0 \text{ mA}$ $ I_{OUT} \leq 5.2 \text{ mA}$	4.5V	0.2	0.26	0.33	0.4	V
			6.0V	0.2	0.26	0.33	0.4	V
I_{IN}	Maximum Input Current	$V_{IN} = V_{CC}$ or GND	6.0V		± 0.1	± 1.0	± 1.0	μA
I_{CC}	Maximum Quiescent Supply Current	$V_{IN} = V_{CC}$ or GND $I_{OUT} = 0 \mu\text{A}$	6.0V		2.0	20	40	μA

Note 4: For a power supply of 5V $\pm 10\%$ the worst case output voltages (V_{OH} , and V_{OL}) occur for HC at 4.5V. Thus the 4.5V values should be used when designing with this supply. Worst case V_{IH} and V_{IL} occur at $V_{CC} = 5.5V$ and 4.5V respectively. (The V_{IH} value at 5.5V is 3.85V.) The worst case leakage current (I_{IN} , I_{CC} , and I_{OZ}) occur for CMOS at the higher voltage and so the 6.0V values should be used.

AC Electrical Characteristics								
V _{CC} = 5V, T _A = 25°C, C _L = 15 pF, t _r = t _f = 6 ns								
Symbol	Parameter	Conditions	Typ	Guaranteed Limit		Units		
t _{PHL} , t _{PLH}	Maximum Propagation Delay		8	15		ns		
AC Electrical Characteristics								
V _{CC} = 2.0V to 6.0V, C _L = 50 pF, t _r = t _f = 6 ns (unless otherwise specified)								
Symbol	Parameter	Conditions	V _{CC}	T _A = 25°C		T _A = -40 to 85°C	T _A = -55 to 125°C	Units
				Typ	Guaranteed Limits			
t _{PHL} , t _{PLH}	Maximum Propagation Delay		2.0V	45	90	113	134	ns
			4.5V	9	18	23	27	ns
			6.0V	8	15	19	23	ns
t _{TLH} , t _{THL}	Maximum Output Rise and Fall Time		2.0V	30	75	95	110	ns
			4.5V	8	15	19	22	ns
			6.0V	7	13	16	19	ns
C _{PD}	Power Dissipation Capacitance (Note 5)	(per gate)		20				pF
C _{IN}	Maximum Input Capacitance			5	10	10	10	pF
<p>Note 5: C_{PD} determines the no load dynamic power consumption, P_D = C_{PD} V_{CC}² f + I_{CC} V_{CC}, and the no load dynamic current consumption, I_S = C_{PD} V_{CC} f + I_{CC}.</p>								

Physical Dimensions inches (millimeters) unless otherwise noted

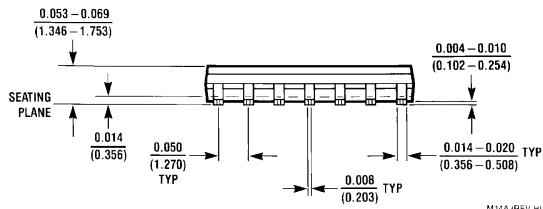
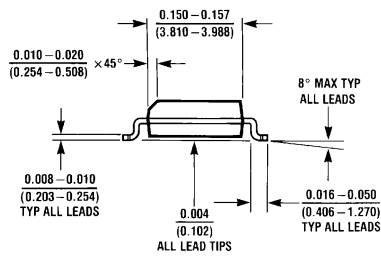
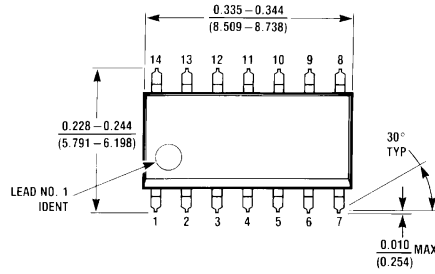

M14A (REV HI)

**14-Lead Small Outline Integrated Circuit (SOIC), JEDEC MS-120, 0.150" Narrow Body
Package Number M14A**

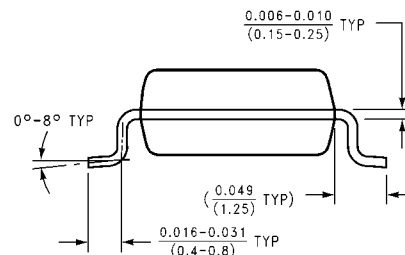
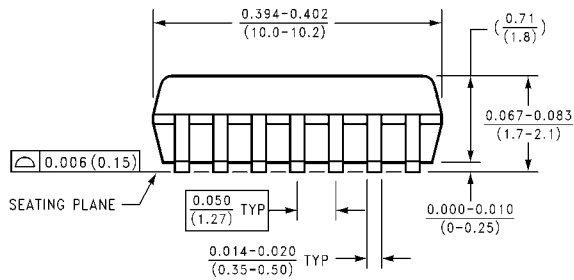
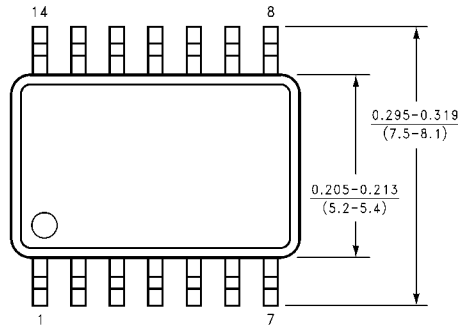

M14D (REV B)

**14-Lead Small Outline Package (SOP), EIAJ TYPE II, 5.3mm Wide
Package Number M14D**

Physical Dimensions inches (millimeters) unless otherwise noted (Continued)

14LD, TSSOP, JEDEC MO-153, 4.4MM WIDE

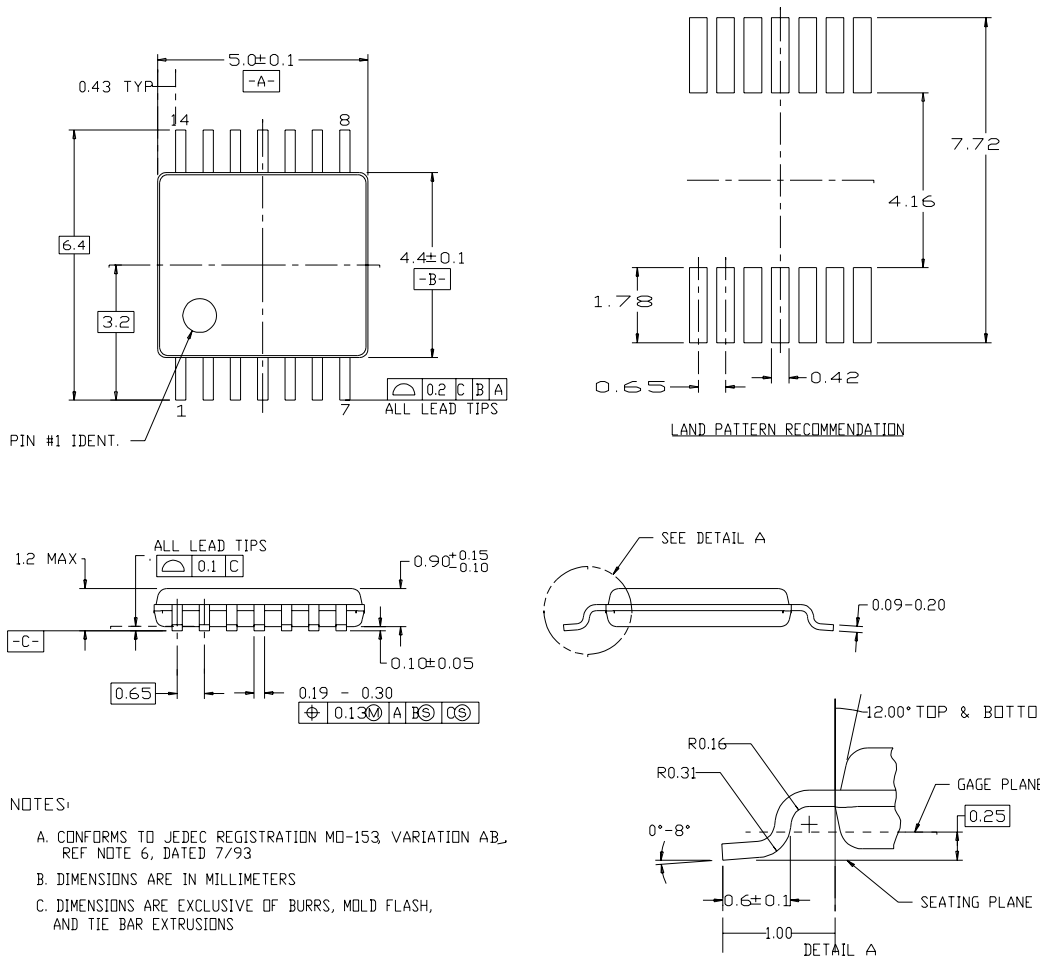

**14-Lead Thin Shrink Small Outline Package (TSSOP), JEDEC MO-153, 4.4mm Wide
Package Number MTC14**

Physical Dimensions inches (millimeters) unless otherwise noted (Continued)



14-Lead Plastic Dual-In-Line Package (PDIP), JEDEC MS-001, 0.300" Wide Package Number N14A

LIFE SUPPORT POLICY

FAIRCHILD'S PRODUCTS ARE NOT AUTHORIZED FOR USE AS CRITICAL COMPONENTS IN LIFE SUPPORT DEVICES OR SYSTEMS WITHOUT THE EXPRESS WRITTEN APPROVAL OF THE PRESIDENT OF FAIRCHILD SEMICONDUCTOR CORPORATION. As used herein:

1. Life support devices or systems are devices or systems which, (a) are intended for surgical implant into the body, or (b) support or sustain life, and (c) whose failure to perform when properly used in accordance with instructions for use provided in the labeling, can be reasonably expected to result in a significant injury to the user.
2. A critical component in any component of a life support device or system whose failure to perform can be reasonably expected to cause the failure of the life support device or system, or to affect its safety or effectiveness.

www.fairchildsemi.com