

KA431S/KA431SA/KA431SL

Programmable Shunt Regulator

Features

- Programmable Output Voltage to 36 Volts
- Low Dynamic Output Impedance 0.20 Typical
- Sink Current Capability of 1.0 to 100mA
- Equivalent Full-Range Temperature Coefficient of 50ppm/°C Typical
- Temperature Compensated for Operation Over Full Rated Operating Temperature Range
- Low Output Noise Voltage
- Fast Turn-on Response

Description

The KA431S/KA431SA/KA431SL are three-terminal adjustable regulator series with a guaranteed thermal stability over applicable temperature ranges. The output voltage may be set to any value between V_{REF} (approximately 2.5 volts) and 36 volts with two external resistors. These devices have a typical dynamic output impedance of 0.2W. Active output circuitry provides a very sharp turn on characteristic, making these devices excellent replacement for zener diodes in many applications.

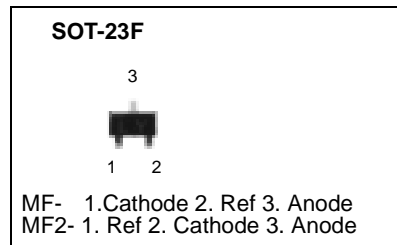

Internal Block Diagram

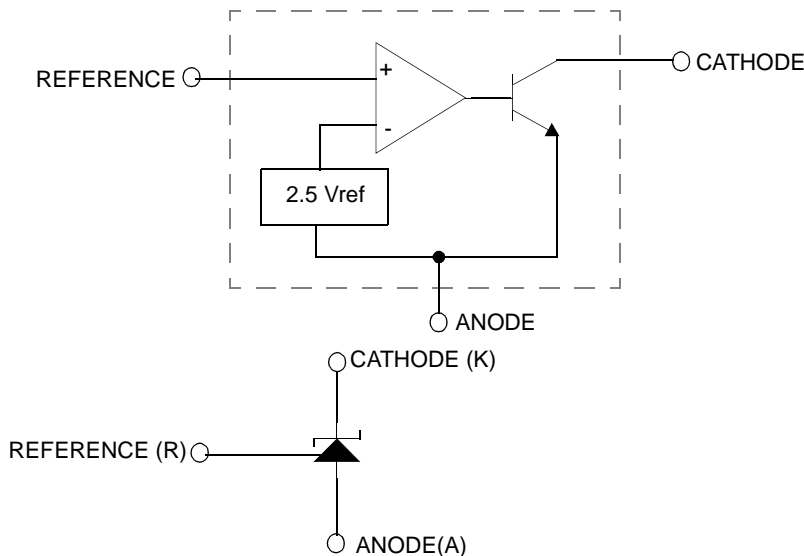

Absolute Maximum Ratings

(Operating temperature range applies unless otherwise specified.)

Parameter	Symbol	Value	Unit
Cathode Voltage	V _{KA}	37	V
Cathode Current Range (Continuous)	I _{KA}	-100 ~ +150	mA
Reference Input Current Range	I _{REF}	-0.05 ~ +10	mA
Thermal Resistance Junction-Air (Note1,2) MF Suffix Package	R _{θJA}	350	°C/W
Power Dissipation (Note3,4) MF Suffix Package	P _D	350	mW
Junction Temperature	T _J	150	°C
Operating Temperature Range	T _{OPR}	-25 ~ +85	°C
Storage Temperature Range	T _{STG}	-65 ~ +150	°C

Note :

- Thermal resistance test board
Size: 76.2mm * 114.3mm * 1.6mm (1S0P)
JEDEC Standard: JESD51-3, JESD51-7
- Assume no ambient airflow.
- T_{JMAX} = 150 °C, Ratings apply to ambient temperature at 25 °C
- Power dissipation calculation: $P_D = (T_J - T_A)/R_{\theta JA}$

Recommended Operating Conditions

Parameter	Symbol	Min.	Typ.	Max.	Unit
Cathode Voltage	V _{KA}	V _{REF}	-	36	V
Cathode Current	I _{KA}	1.0	-	100	mA

Electrical Characteristics

($T_A = +25^\circ\text{C}$, unless otherwise specified)

Parameter	Symbol	Conditions	KA431S			KA431SA			KA431SL			Unit
			Min.	Typ.	Max.	Min.	Typ.	Max.	Min.	Typ.	Max.	
Reference Input Voltage	V_{REF}	$V_{KA}=V_{REF}$, $I_{KA}=10\text{mA}$	2.450	2.500	2.550	2.470	2.495	2.520	2.482	2.495	2.508	V
Deviation of Reference Input Voltage Over-Temperature	$\Delta V_{REF}/\Delta T$	$V_{KA}=V_{REF}$, $I_{KA}=10\text{mA}$ $T_{MIN}\leq T_A\leq T_{MAX}$	-	4.5	17	-	4.5	17	-	4.5	17	mV
Ratio of Change in Reference Input Voltage to the Change in Cathode Voltage	$\Delta V_{REF}/\Delta V_{KA}$	$I_{KA}=10\text{mA}$ $\Delta V_{KA}=10\text{V}-V_{REF}$	-	-1.0	-2.7	-	-1.0	-2.7	-	-1.0	-2.7	mV/V
		$\Delta V_{KA}=36\text{V}-10\text{V}$	-	-0.5	-2.0	-	-0.5	-2.0	-	-0.5	-2.0	
Reference Input Current	I_{REF}	$I_{KA}=10\text{mA}$, $R_1=10\text{k}\Omega$, $R_2=\infty$	-	1.5	4	-	1.5	4	-	1.5	4	μA
Deviation of Reference Input Current Over Full Temperature Range	$\Delta I_{REF}/\Delta T$	$I_{KA}=10\text{mA}$, $R_1=10\text{k}\Omega$, $R_2=\infty$ $T_A = \text{Full Range}$	-	0.4	1.2	-	0.4	1.2	-	0.4	1.2	μA
Minimum Cathode Current for Regulation	$I_{KA(MIN)}$	$V_{KA}=V_{REF}$	-	0.45	1.0	-	0.45	1.0	-	0.45	1.0	mA
Off - Stage Cathode Current	$I_{KA(OFF)}$	$V_{KA}=36\text{V}$, $V_{REF}=0$	-	0.05	1.0	-	0.05	1.0	-	0.05	1.0	μA
Dynamic Impedance	Z_{KA}	$V_{KA}=V_{REF}$, $I_{KA}=1\text{ to }100\text{mA}$ $f\geq 1.0\text{kHz}$	-	0.15	0.5	-	0.15	0.5	-	0.15	0.5	Ω

- $T_{MIN} = -25^\circ\text{C}$, $T_{MAX} = +85^\circ\text{C}$

Test Circuits

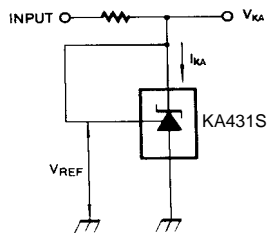

Figure 1. Test Circuit for $V_{KA} = V_{REF}$

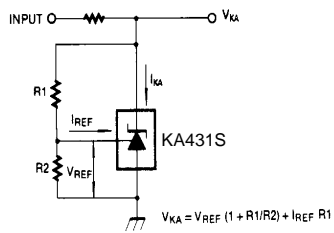

Figure 2. Test Circuit for $V_{KA} \geq V_{REF}$

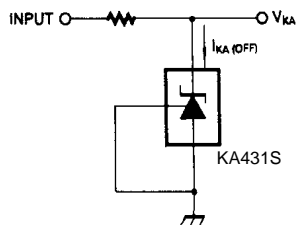

Figure 3. Test Circuit for $I_{KA(OFF)}$

Typical Performance Characteristics

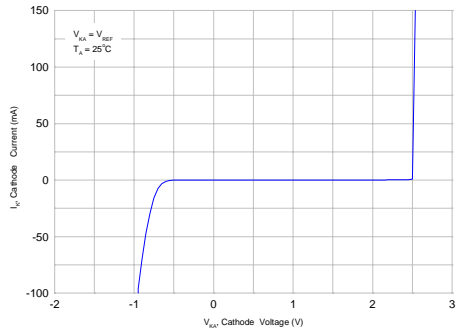

Figure 4. Cathode Current vs. Cathode Voltage

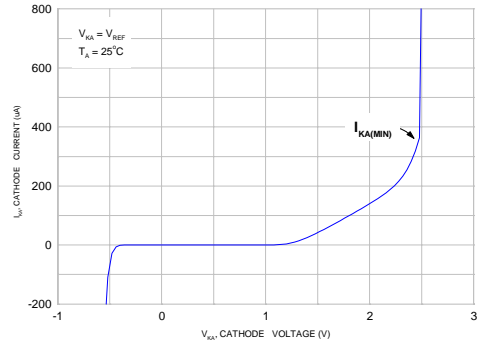

Figure 5. Cathode Current vs. Cathode Voltage

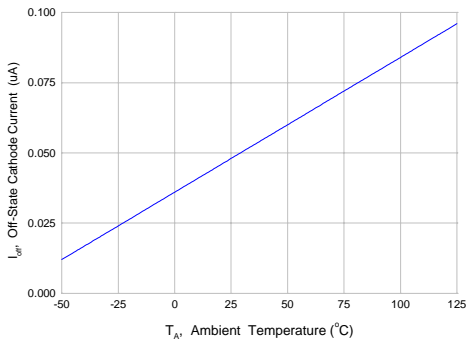

Figure 6. OFF-State Cathode Current vs. Ambient Temperature

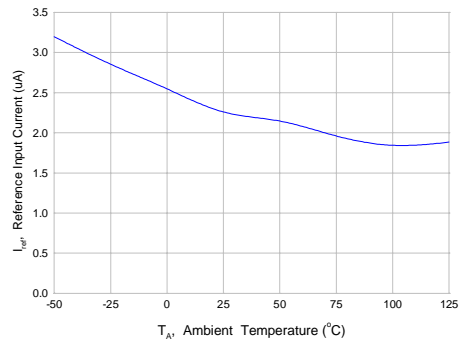

Figure 7. Reference Input Current vs. Ambient Temperature

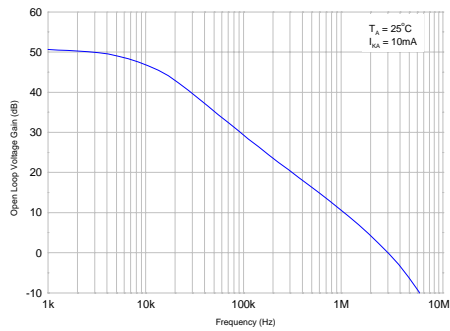

Figure 8. Small Signal Voltage Amplification vs. Frequency

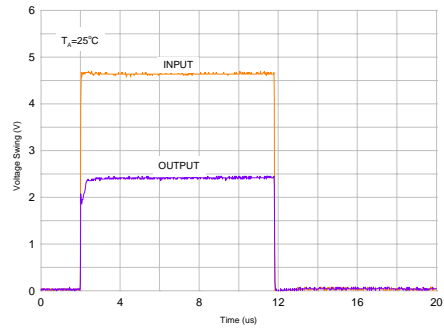

Figure 9. Pulse Response

Typical Performance Characteristics (Continued)

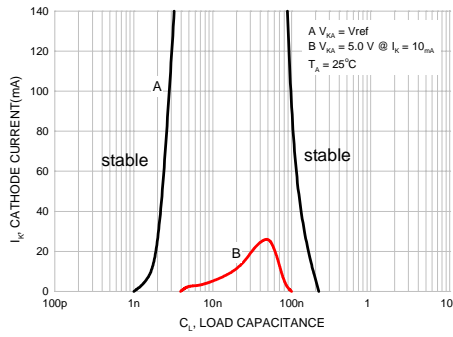

Figure 10. Stability Boundary Conditions

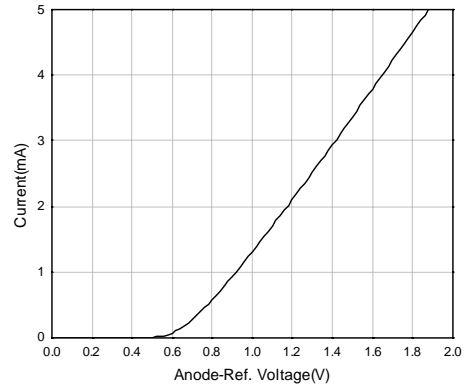

Figure 11. Anode-Reference Diode Curve

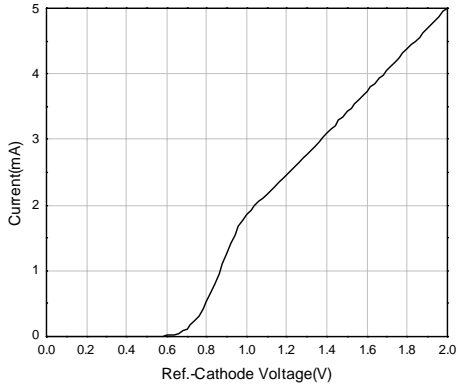

Figure 12. Reference-Cathode Diode Curve

Typical Application

$$V_O = \left(1 + \frac{R_1}{R_2}\right) V_{ref}$$

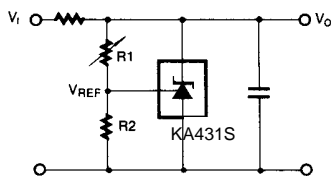

Figure 13. Shunt Regulator

$$V_O = V_{ref} \left(1 + \frac{R_1}{R_2}\right)$$

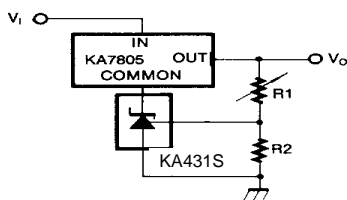

Figure 14. Output Control for Three-Terminal Fixed Regulator

$$V_O = \left(1 + \frac{R_1}{R_2}\right) V_{ref}$$

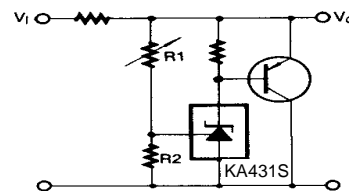

Figure 15. High Current Shunt Regulator

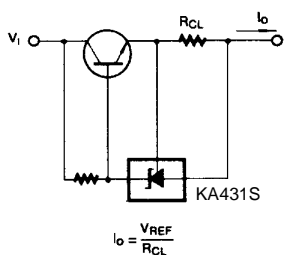

Figure 16. Current Limit or Current Source

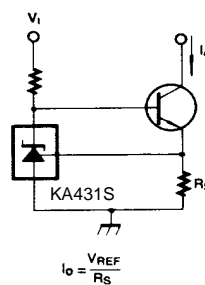

Figure 17. Constant-Current Sink

Mechanical Dimensions

Package

Dimensions in millimeters

SOT-23F

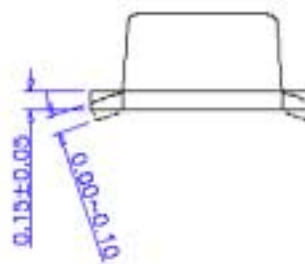
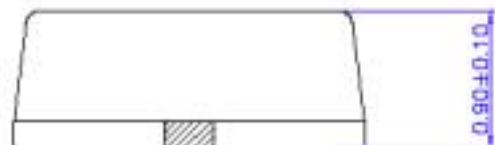
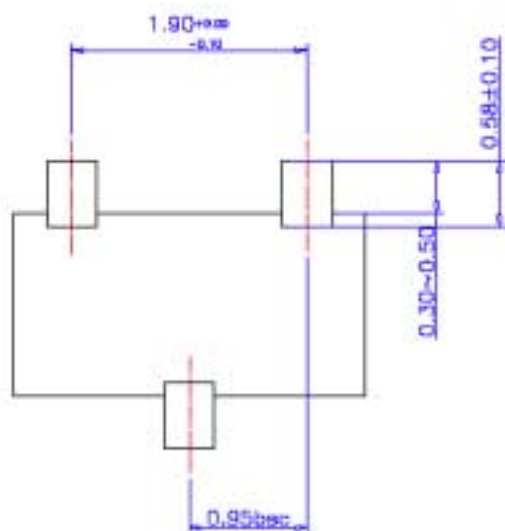
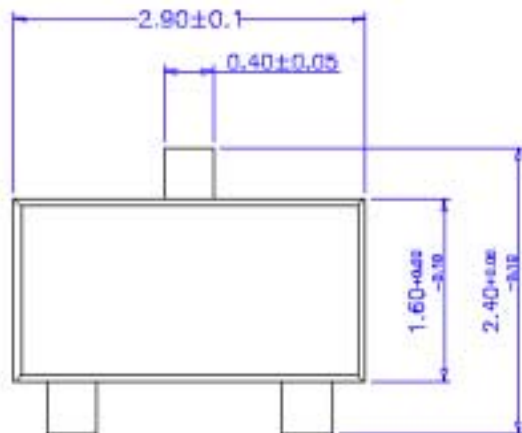

Marking

Ordering Information

Product Number	Output Voltage Tolerance	Package	Operating Temperature
KA431SLMF	0.5%	SOT-23F	-25 ~ +85°C
KA431SAMF	1%	SOT-23F	
KA431SMF	2%	SOT-23F	
KA431SLMF2	0.5%	SOT-23F	
KA431SAMF2	1%	SOT-23F	
KA431SMF2	2%	SOT-23F	

DISCLAIMER

FAIRCHILD SEMICONDUCTOR RESERVES THE RIGHT TO MAKE CHANGES WITHOUT FURTHER NOTICE TO ANY PRODUCTS HEREIN TO IMPROVE RELIABILITY, FUNCTION OR DESIGN. FAIRCHILD DOES NOT ASSUME ANY LIABILITY ARISING OUT OF THE APPLICATION OR USE OF ANY PRODUCT OR CIRCUIT DESCRIBED HEREIN; NEITHER DOES IT CONVEY ANY LICENSE UNDER ITS PATENT RIGHTS, NOR THE RIGHTS OF OTHERS.

LIFE SUPPORT POLICY

FAIRCHILD'S PRODUCTS ARE NOT AUTHORIZED FOR USE AS CRITICAL COMPONENTS IN LIFE SUPPORT DEVICES OR SYSTEMS WITHOUT THE EXPRESS WRITTEN APPROVAL OF THE PRESIDENT OF FAIRCHILD SEMICONDUCTOR CORPORATION. As used herein:

1. Life support devices or systems are devices or systems which, (a) are intended for surgical implant into the body, or (b) support or sustain life, and (c) whose failure to perform when properly used in accordance with instructions for use provided in the labeling, can be reasonably expected to result in a significant injury of the user.
2. A critical component in any component of a life support device or system whose failure to perform can be reasonably expected to cause the failure of the life support device or system, or to affect its safety or effectiveness.