



**IRF330-333/IRF730-733**  
**MTM/MTP5N35/5N40**  
**N-Channel Power MOSFETs,**  
**5.5 A, 350 V/400 V**

Power And Discrete Division

T-39-11

**Description**

These devices are n-channel, enhancement mode, power MOSFETs designed especially for high voltage, high speed applications, such as off-line switching power supplies, UPS, AC and DC motor controls, relay and solenoid drivers.

- $V_{GS}$  Rated at  $\pm 20$  V
- Silicon Gate for Fast Switching Speeds
- $I_{DSS}$ ,  $V_{DS(on)}$ , SOA and  $V_{GS(th)}$  Specified at Elevated Temperature
- Rugged

TO-204AA

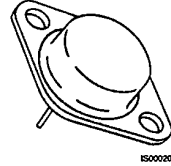

TO-220AB

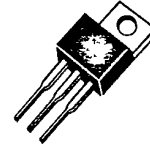

IRF330  
 IRF331  
 IRF332  
 IRF333  
 MTM5N35  
 MTM5N40

IRF730  
 IRF731  
 IRF732  
 IRF733  
 MTP5N35  
 MTP5N40

**Maximum Ratings**

Symbol	Characteristic	Rating IRF330/332 IRF730/732 MTM/MTP5N40	Rating IRF331/333 IRF731/733 MTM/MTP5N35	Unit
$V_{DSS}$	Drain to Source Voltage	400	350	V
$V_{DGR}$	Drain to Gate Voltage $R_{GS} = 1.0 M\Omega$	400	350	V
$V_{GS}$	Gate to Source Voltage	$\pm 20$	$\pm 20$	V
$T_J, T_{stg}$	Operating Junction and Storage Temperature	-55 to +150	-55 to +150	$^{\circ}C$
$T_L$	Maximum Lead Temperature for Soldering Purposes, 1/8" From Case for 5 s	275	275	$^{\circ}C$

**Maximum On-State Characteristics**

		IRF330/331 IRF730/731	IRF332/333 IRF732/733	MTM5N35/40 MTP5N35/40	
$R_{DS(on)}$	Static Drain-to-Source On Resistance	1.0	1.5	1.0	$\Omega$
$I_D$	Drain Current Continuous Pulsed	5.5 22	4.5 22	5.0 22	A

**Maximum Thermal Characteristics**

		1.67	1.67	1.67	$^{\circ}C/W$
$R_{\theta JC}$	Thermal Resistance, Junction to Case				
$P_D$	Total Power Dissipation at $T_C = 25^{\circ}C$	75	75	75	W

**Notes**  
 For information concerning connection diagram and package outline, refer to Section 7.

## IRF330-333/IRF730-733

T-39-11

Electrical Characteristics ( $T_C = 25^\circ\text{C}$  unless otherwise noted)

Symbol	Characteristic	Min	Max	Unit	Test Conditions
--------	----------------	-----	-----	------	-----------------

## Off Characteristics

$V_{(BR)DSS}$	Drain Source Breakdown Voltage <sup>1</sup>			V	$V_{GS} = 0\text{ V}, I_D = 250\ \mu\text{A}$
	IRF330/332/730/732	400			
	IRF331/333/731/733	350			
$I_{DSS}$	Zero Gate Voltage Drain Current		250	$\mu\text{A}$	$V_{DS} = \text{Rated } V_{DSS}, V_{GS} = 0\text{ V}$
			1000	$\mu\text{A}$	$V_{DS} = 0.8 \times \text{Rated } V_{DSS}, V_{GS} = 0\text{ V}, T_C = 125^\circ\text{C}$
$I_{GSS}$	Gate-Body Leakage Current IRF330-333 IRF730-733		$\pm 100$ $\pm 500$	nA	$V_{GS} = \pm 20\text{ V}, V_{DS} = 0\text{ V}$

## On Characteristics

$V_{GS(th)}$	Gate Threshold Voltage	2.0	4.0	V	$I_D = 250\ \mu\text{A}, V_{DS} = V_{GS}$
$R_{DS(on)}$	Static Drain-Source On-Resistance <sup>2</sup>			$\Omega$	$V_{GS} = 10\text{ V}, I_D = 3.0\text{ A}$
			1.0		
			1.5		
$g_{fs}$	Forward Transconductance	3.0		S ( $\Omega$ )	$V_{DS} = 10\text{ V}, I_D = 3.0\text{ A}$

## Dynamic Characteristics

$C_{iss}$	Input Capacitance		900	pF	$V_{DS} = 25\text{ V}, V_{GS} = 0\text{ V}$ $f = 1.0\text{ MHz}$
$C_{oss}$	Output Capacitance		300	pF	
$C_{rss}$	Reverse Transfer Capacitance		80	pF	

Switching Characteristics ( $T_C = 25^\circ\text{C}$ , Figures 12, 13)

$t_{d(on)}$	Turn-On Delay Time		30	ns	$V_{DD} = 175\text{ V}, I_D = 3.0\text{ A}$ $V_{GS} = 10\text{ V}, R_{GEN} = 15\ \Omega$ $R_{GS} = 15\ \Omega$
$t_r$	Rise Time		35	ns	
$t_{d(off)}$	Turn-Off Delay Time		55	ns	
$t_f$	Fall Time		35	ns	
$Q_g$	Total Gate Charge		30	nC	$V_{GS} = 10\text{ V}, I_D = 7.0\text{ A}$ $V_{DD} = 180\text{ V}$

Symbol	Characteristic	Typ	Max	Unit	Test Conditions
--------	----------------	-----	-----	------	-----------------

## Source-Drain Diode Characteristics

$V_{SD}$	Diode Forward Voltage IRF330/331/730/731		1.6	V	$I_S = 5.5\text{ A}; V_{GS} = 0\text{ V}$
	IRF332/333/732/733		1.5	V	$I_S = 4.5\text{ A}; V_{GS} = 0\text{ V}$
$t_{rr}$	Reverse Recovery Time	400		ns	$I_S = 5.5\text{ A}; di_S/dt = 100\text{ A}/\mu\text{S}$

## MTM/MTP5N35/5N40

T-39-11

Electrical Characteristics ( $T_C = 25^\circ\text{C}$  unless otherwise noted)

Symbol	Characteristic	Min	Max	Unit	Test Conditions
<b>Off Characteristics</b>					
$V_{(BR)DSS}$	Drain Source Breakdown Voltage <sup>1</sup>			V	$V_{GS} = 0\text{ V}, I_D = 5.0\text{ mA}$
	MTM/MTP5N40	400			
	MTM/MTP5N35	350			
$I_{DSS}$	Zero Gate Voltage Drain Current		0.25	mA	$V_{DS} = 0.85 \times \text{Rated } V_{DSS}, V_{GS} = 0\text{ V}$
			2.5	mA	$V_{DS} = 0.85 \times \text{Rated } V_{DSS}, V_{GS} = 0\text{ V}, T_C = 100^\circ\text{C}$
$I_{GSS}$	Gate-Body Leakage Current		$\pm 500$	nA	$V_{GS} = \pm 20\text{ V}, V_{DS} = 0\text{ V}$
<b>On Characteristics</b>					
$V_{GS(th)}$	Gate Threshold Voltage	2.0	4.5	V	$I_D = 1.0\text{ mA}, V_{DS} = V_{GS}$
		1.5	4.0	V	$I_D = 1.0\text{ mA}, V_{DS} = V_{GS}, T_C = 100^\circ\text{C}$
$R_{DS(on)}$	Static Drain-Source On-Resistance <sup>2</sup>		1.0	$\Omega$	$V_{GS} = 10\text{ V}, I_D = 2.5\text{ A}$
$V_{DS(on)}$	Drain-Source On-Voltage <sup>2</sup>		2.5	V	$V_{GS} = 10\text{ V}; I_D = 2.5\text{ A}$
			6.2	V	$V_{GS} = 10\text{ V}, I_D = 5.0\text{ A}$
			5.0	V	$V_{GS} = 10\text{ V}, I_D = 2.5\text{ A}, T_C = 100^\circ\text{C}$
$g_{fs}$	Forward Transconductance	2.0		S ( $\Omega$ )	$V_{DS} = 10\text{ V}, I_D = 2.5\text{ A}$
<b>Dynamic Characteristics</b>					
$C_{iss}$	Input Capacitance		1200	pF	$V_{DS} = 25\text{ V}, V_{GS} = 0\text{ V}, f = 1.0\text{ MHz}$
$C_{oss}$	Output Capacitance		300	pF	
$C_{rss}$	Reverse Transfer Capacitance		80	pF	
<b>Switching Characteristics (<math>T_C = 25^\circ\text{C}</math>, Figures 12, 13)<sup>3</sup></b>					
$t_{d(on)}$	Turn-On Delay Time		50	ns	$V_{DD} = 25\text{ V}, I_D = 2.5\text{ A}, V_{GS} = 10\text{ V}, R_{GEN} = 50\ \Omega, R_{GS} = 50\ \Omega$
$t_r$	Rise Time		100	ns	
$t_{d(off)}$	Turn-Off Delay Time		200	ns	
$t_f$	Fall Time		100	ns	
$Q_g$	Total Gate Charge		30	nC	$V_{GS} = 10\text{ V}, I_D = 7.0\text{ A}, V_{DD} = 180\text{ V}$

## Notes

- $T_J = +25^\circ\text{C}$  to  $+150^\circ\text{C}$
- Pulse test: Pulse width  $\leq 80\ \mu\text{s}$ , Duty cycle  $\leq 1\%$
- Switching time measurements performed on LEM TR-58 test equipment.

IRF330-333/IRF730-733  
MTM/MTP5N35/5N40

T-39-11

Typical Performance Curves

Figures 4-6 for IRF332/333/732/733 only.

Figure 1 Output Characteristics

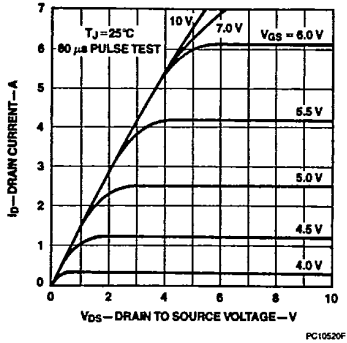

Figure 2 Static Drain to Source Resistance vs Drain Current

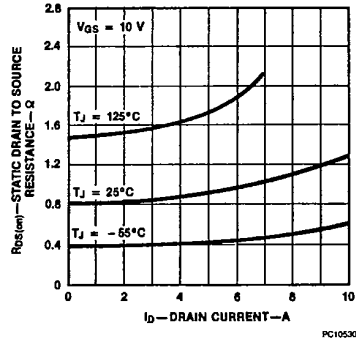

Figure 3 Transfer Characteristics

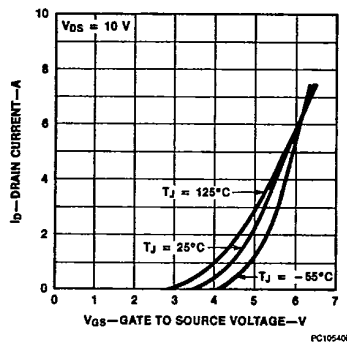

Figure 4 Output Characteristics

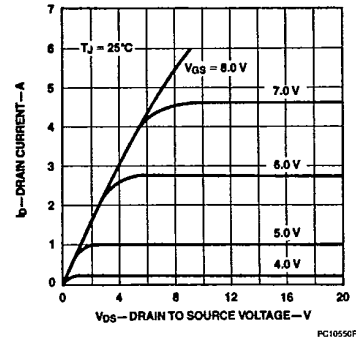

Figure 5 Static Drain to Source On-Resistance vs Drain Current

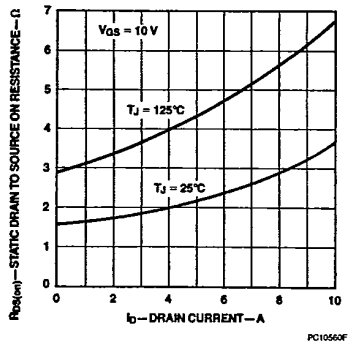
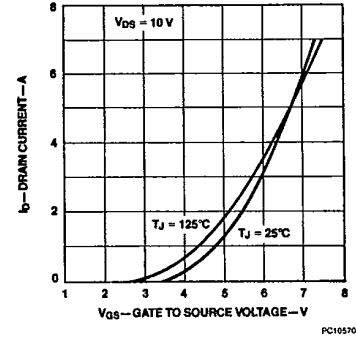

Figure 6 Transfer Characteristics



**IRF330-333/IRF730-733**  
**MTM/MTP5N35/5N40**

T-39-11

Typical Performance Curves (Cont.)

Figure 7 Temperature Variation of Gate to Source Threshold Voltage

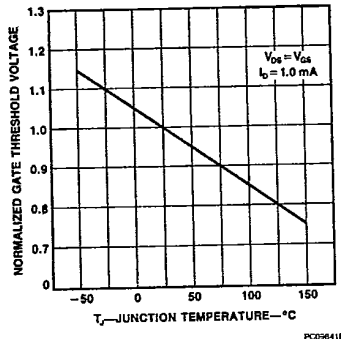

PC09641F

Figure 8 Capacitance vs Drain to Source Voltage

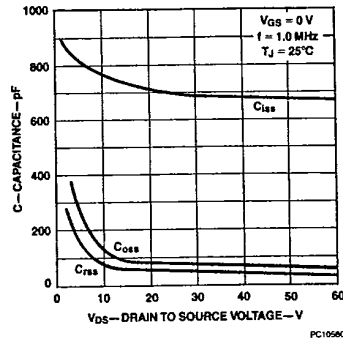

PC10560F

Figure 9 Gate to Source Voltage vs Total Gate Charge

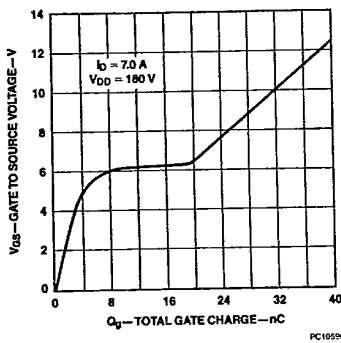

PC10550F

Figure 10 Forward Biased Safe Operating Area

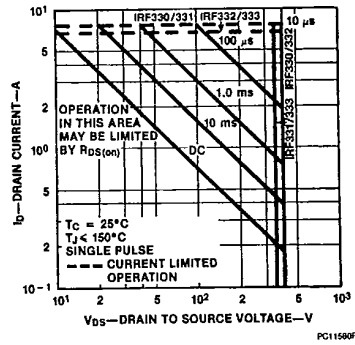

PC11560F

Figure 11 Transient Thermal Resistance

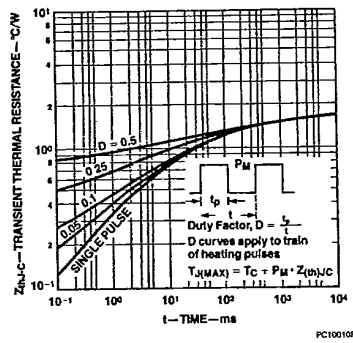

PC10010F

IRF330-333/IRF730-733  
MTM/MTP5N35/5N40

T-39-11

Typical Electrical Characteristics

Figure 12 Switching Test Circuit

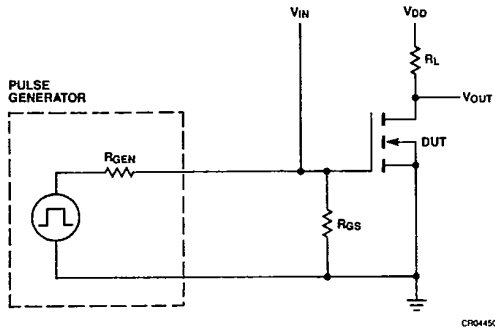
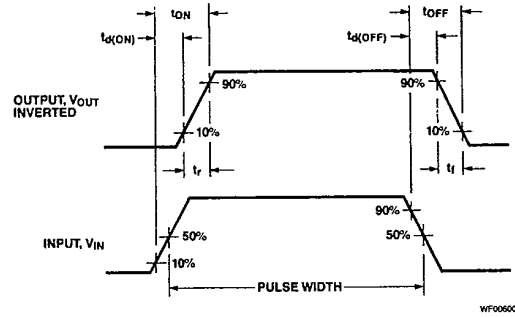

Figure 13 Switching Waveforms



2