

**FAIRCHILD**

A Schlumberger Company

**IRF120-123/IRF520-523 T-39-11**

**MTP10N08/10N10**

**N-Channel Power MOSFETs,  
11 A, 60-100 V**

Power And Discrete Division

**Description**

These devices are n-channel, enhancement mode, power MOSFETs designed especially for high speed applications, such as switching power supplies, converters, AC and DC motor controls, relay and solenoid drivers and other pulse circuits.

- Low  $R_{DS(on)}$
- $V_{GS}$  Rated at  $\pm 20$  V
- Silicon Gate for Fast Switching Speeds
- $I_{DSS}$ ,  $V_{DS(on)}$ , Specified at Elevated Temperature
- Rugged
- Low Drive Requirements
- Ease of Paralleling

TO-204AA

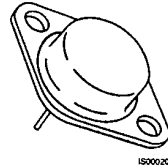

- IRF120
- IRF121
- IRF122
- IRF123

TO-220AB

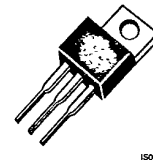

- IRF520
- IRF521
- IRF522
- IRF523
- MTP10N08
- MTP10N10

2

**Product Summary**

Part Number	$V_{DSS}$	$R_{DS(on)}$	$I_D$ at $T_C = 25^\circ C$	$I_D$ at $T_C = 100^\circ C$	Case Style
IRF120	100 V	0.30 $\Omega$	8.0 A	5.0 A	TO-204AA
IRF121	60 V	0.30 $\Omega$	8.0 A	5.0 A	
IRF122	100 V	0.40 $\Omega$	7.0 A	4.0 A	
IRF123	60 V	0.40 $\Omega$	7.0 A	4.0 A	
IRF520	100 V	0.30 $\Omega$	8.0 A	5.0 A	TO-220AB
IRF521	60 V	0.30 $\Omega$	8.0 A	5.0 A	
IRF522	100 V	0.40 $\Omega$	7.0 A	4.0 A	
IRF523	60 V	0.40 $\Omega$	7.0 A	4.0 A	
MTP10N08	80 V	0.33 $\Omega$	10 A	6.4 A	
MTP10N10	100 V	0.33 $\Omega$	10 A	6.4 A	

**Notes**

For information concerning connection diagram and package outline, refer to Section 7.

**IRF120-123/IRF520-523**  
**MTP10N08/10N10**

.T-39-11

**Maximum Ratings**

Symbol	Characteristic	Rating IRF120/122 IRF520/522 MTP10N10	Rating MTP10N08	Rating IRF122/123 IRF522/523	Unit
V <sub>DSS</sub>	Drain to Source Voltage <sup>1</sup>	100	80	60	V
V <sub>DGR</sub>	Drain to Gate Voltage <sup>1</sup> R <sub>GS</sub> = 20 kΩ	100	80	60	V
V <sub>GS</sub>	Gate to Source Voltage	± 20	± 20	± 20	V
T <sub>J</sub> , T <sub>stg</sub>	Operating Junction and Storage Temperatures	-55 to +150	-55 to +150	-55 to +150	°C
T <sub>L</sub>	Maximum Lead Temperature for Soldering Purposes, 1/8" From Case for 5 s	275	275	275	°C

**Maximum Thermal Characteristics**

		IRF120-123/IRF520-523	MTP10N08/10	
R <sub>θJC</sub>	Thermal Resistance, Junction to Case	3.12	1.67	°C/W
R <sub>θJA</sub>	Thermal Resistance, Junction to Ambient	30/80	80	°C/W
P <sub>D</sub>	Total Power Dissipation at T <sub>C</sub> = 25°C	40	75	W
I <sub>DM</sub>	Pulsed Drain Current <sup>2</sup>	20	32	A

**Electrical Characteristics (T<sub>C</sub> = 25°C unless otherwise noted)**

Symbol	Characteristic	Min	Max	Unit	Test Conditions
<b>Off Characteristics</b>					
V <sub>(BR)DSS</sub>	Drain Source Breakdown Voltage <sup>1</sup> IRF120/122/520/522/ MTP10N10 MTP10N08 IRF121/123/521/523	100 80 60		V	V <sub>GS</sub> = 0 V, I <sub>D</sub> = 250 μA
I <sub>DSS</sub>	Zero Gate Voltage Drain Current		250 1000	μA μA	V <sub>DS</sub> = Rated V <sub>DSS</sub> , V <sub>GS</sub> = 0 V V <sub>DS</sub> = 0.8 x Rated V <sub>DSS</sub> , V <sub>GS</sub> = 0 V, T <sub>C</sub> = 125°C
I <sub>GSS</sub>	Gate-Body Leakage Current IRF120-123 IRF520-523/MTP10N08/10		± 100 ± 500	nA	V <sub>GS</sub> = ± 20 V, V <sub>DS</sub> = 0 V

**IRF120-123/IRF520-523**  
**MTP10N08/10N10**

T-39-11

**Electrical Characteristics (Cont.)** ( $T_C = 25^\circ\text{C}$  unless otherwise noted)

Symbol	Characteristic	Min	Max	Unit	Test Conditions
<b>On Characteristics</b>					
$V_{GS(th)}$	Gate Threshold Voltage			V	$I_D = 250 \mu\text{A}$ , $V_{DS} = V_{GS}$ $I_D = 1 \text{ mA}$ , $V_{DS} = V_{GS}$
	IRF120-123/IRF520-523	2.0	4.0		
	MTP10N08/10N10	2.0	4.5		
$R_{DS(on)}$	Static Drain-Source On-Resistance <sup>2</sup>			$\Omega$	$V_{GS} = 10 \text{ V}$ $I_D = 4.0 \text{ A}$ $I_D = 5.0 \text{ A}$ $I_D = 4.0 \text{ A}$
	IRF120/121/520/521		0.30		
	MTP10N08/10N10		0.33		
	IRF122/123/522/523		0.40		
$V_{DS(on)}$	Drain-Source On-Voltage <sup>2</sup>		4.0	V	$V_{GS} = 10 \text{ V}$ ; $I_D = 10.0 \text{ A}$
	MTP 10N08/10N10		3.3	V	$V_{GS} = 10 \text{ V}$ , $I_D = 5.0 \text{ A}$ $T_C = 100^\circ\text{C}$
$g_{fs}$	Forward Transconductance	1.5		S ( $\Omega$ )	$V_{DS} = 10 \text{ V}$ , $I_D = 4.0 \text{ A}$

**Dynamic Characteristics**

$C_{iss}$	Input Capacitance		600	pF	$V_{DS} = 25 \text{ V}$ , $V_{GS} = 0 \text{ V}$ $f = 1.0 \text{ MHz}$
$C_{oss}$	Output Capacitance		400	pF	
$C_{rss}$	Reverse Transfer Capacitance		100	pF	

**Switching Characteristics** ( $T_C = 25^\circ\text{C}$ , Figures 1, 2)<sup>3</sup>

$t_{d(on)}$	Turn-On Delay Time		40	ns	$V_{DD} = 50 \text{ V}$ , $I_D = 4.0 \text{ A}$ $V_{GS} = 10 \text{ V}$ , $R_{GEN} = 50 \Omega$ $R_{GS} = 50 \Omega$
$t_r$	Rise Time		70	ns	
$t_{d(off)}$	Turn-Off Delay Time		100	ns	
$t_f$	Fall Time		70	ns	
$Q_g$	Total Gate Charge		15	nC	$V_{GS} = 10 \text{ V}$ , $I_D = 10 \text{ A}$ $V_{DD} = 50 \text{ V}$

Symbol	Characteristic	Typ	Max	Unit	Test Conditions
<b>Source-Drain Diode Characteristics</b>					
$V_{SD}$	Diode Forward Voltage		2.5	V	$I_S = 8.0 \text{ A}$ ; $V_{GS} = 0 \text{ V}$
	IRF120/121/520/521		2.3	V	$I_S = 7.0 \text{ A}$ ; $V_{GS} = 0 \text{ V}$
$t_{rr}$	Reverse Recovery Time	280		ns	$I_S = 4.0 \text{ A}$ ; $di_S/dt = 25 \text{ A}/\mu\text{S}$

**Notes**

- $T_J = +25^\circ\text{C}$  to  $+150^\circ\text{C}$
- Pulse width limited by  $T_J$
- Switching time measurements performed on LEM TR-58 test equipment.

IRF120-123/IRF520-523  
MTP10N08/10N10

T-39-11

Typical Electrical Characteristics

Figure 1 Switching Test Circuit

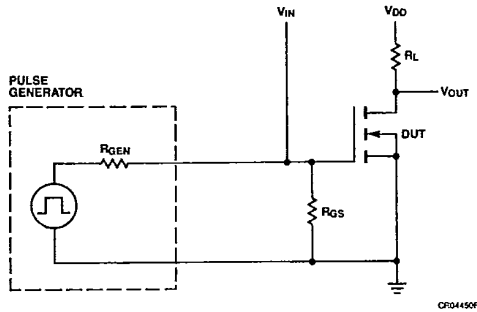
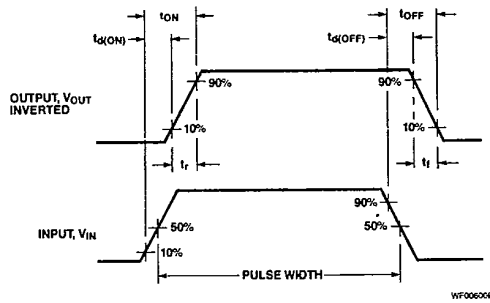

Figure 2 Switching Waveforms



Typical Performance Curves

Figure 3 Output Characteristics

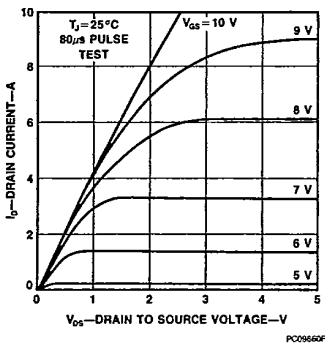

Figure 4 Static Drain to Source Resistance vs Drain Current

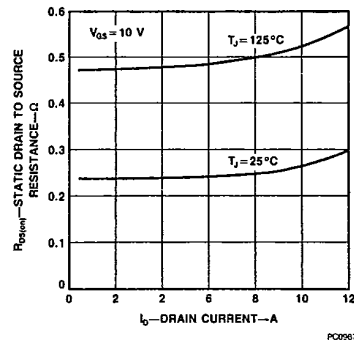

Figure 5 Transfer Characteristics

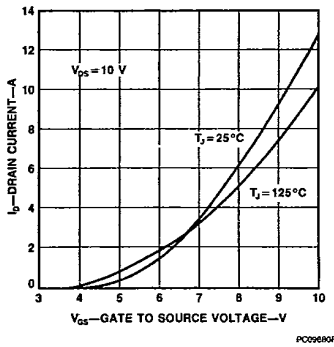
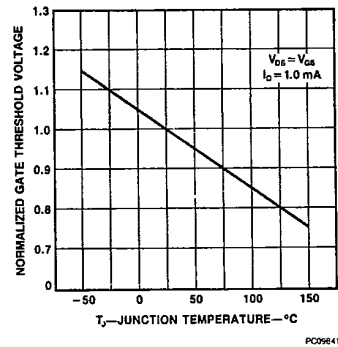

Figure 6 Temperature Variation of Gate to Source Threshold Voltage



IRF120-123/IRF520-523  
MTP10N08/10N10

T-39-11

Typical Performance Curves (Cont.)

Figure 7 Capacitance vs Drain to Source Voltage

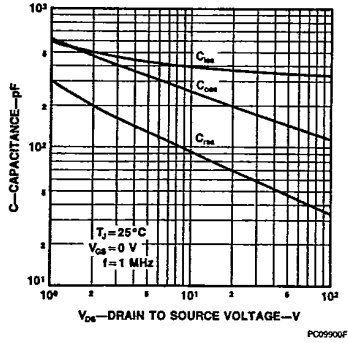

Figure 8 Gate to Source Voltage vs Total Gate Charge

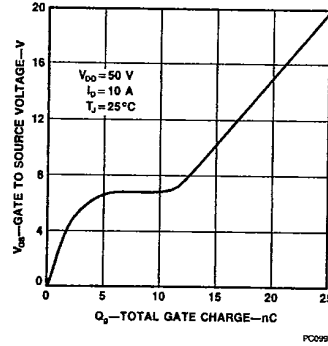

Figure 9 Forward Biased Safe Operating Area for IRF120-123 And IRF520-523

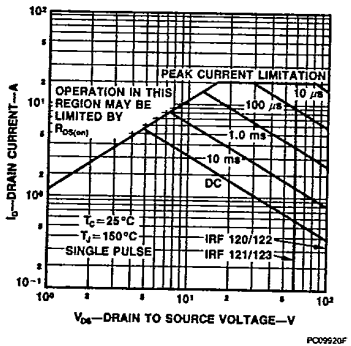

Figure 10 Transient Thermal Resistance vs Time for IRF120-123 And IRF520-523

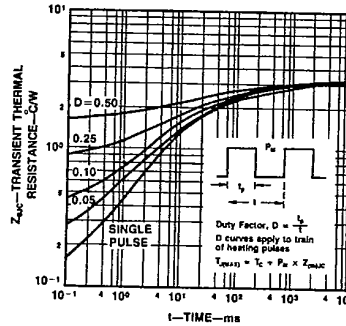

Figure 11 Forward Biased Safe Operating Area for MTP10N08/10N10

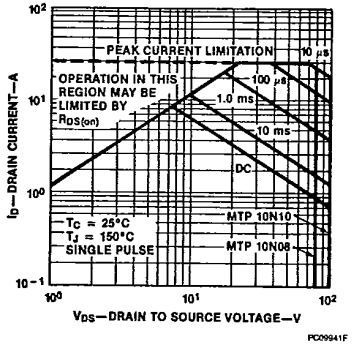

Figure 12 Transient Thermal Resistance vs Time for MTP10N08/10N10

