

**5.8A, 30V, 0.037 Ohm, Dual N-Channel, Logic Level Power MOSFET**

This power MOSFET is manufactured using an innovative process. This advanced process technology achieves the lowest possible on-resistance per silicon area, resulting in outstanding performance. This device is capable of withstanding high energy in the avalanche mode and the diode exhibits very low reverse recovery time and stored charge. It was designed for use in applications where power efficiency is important, such as switching regulators, switching converters, motor drivers, relay drivers, low-voltage bus switches, and power management in portable and battery-operated products.

**Ordering Information**

PART NUMBER	PACKAGE	BRAND
HP4936DY	SO-8	P4936DY

NOTE: When ordering, use the entire part number. Add the suffix T to obtain the variant in tape and reel, e.g., HP4936DYT.

**Features**

- Logic Level Gate Drive
- 5.8A, 30V
- $r_{DS(ON)} = 0.037\Omega$  at  $I_D = 5.8A, V_{GS} = 10V$
- $r_{DS(ON)} = 0.055\Omega$  at  $I_D = 4.7A, V_{GS} = 4.5V$
- Related Literature
  - TB334, "Guidelines for Soldering Surface Mount Components to PC Boards"

**Symbol**

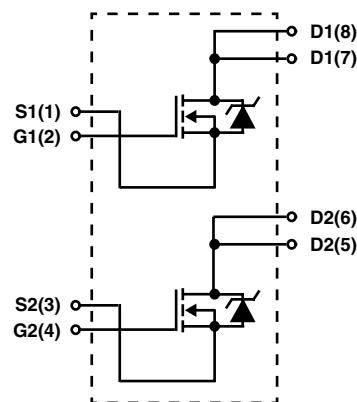

**Packaging**

SO-8

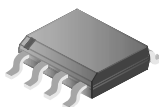

# HP4936DY

## Absolute Maximum Ratings $T_A = 25^\circ\text{C}$ , Unless Otherwise Specified

	HP4936DY	UNITS
Drain to Source Voltage (Note 1) . . . . .	$V_{DSS}$	30 V
Drain to Gate Voltage ( $R_{GS} = 20k\Omega$ ) (Note 1) . . . . .	$V_{DGR}$	30 V
Gate to Source Voltage . . . . .	$V_{GS}$	$\pm 16$ V
Drain Current		
Continuous . . . . .	$I_D$	5.8 A
Pulsed Drain Current (10 $\mu$ s Pulse Width) . . . . .	$I_{DM}$	30 A
Power Dissipation . . . . .	$P_D$	2 W
Derate Above $25^\circ\text{C}$ . . . . .		0.02 W/ $^\circ\text{C}$
Operating and Storage Temperature . . . . .	$T_J, T_{STG}$	-55 to 150 $^\circ\text{C}$
Maximum Temperature for Soldering		
Leads at 0.063in (1.6mm) from Case for 10s. . . . .	$T_L$	300 $^\circ\text{C}$
Package Body for 10s, See Techbrief 334 . . . . .	$T_{pkg}$	260 $^\circ\text{C}$

CAUTION: Stresses above those listed in "Absolute Maximum Ratings" may cause permanent damage to the device. This is a stress only rating and operation of the device at these or any other conditions above those indicated in the operational sections of this specification is not implied.

### NOTE:

- $T_A = 25^\circ\text{C}$  to  $125^\circ\text{C}$ .

## Electrical Specifications $T_A = 25^\circ\text{C}$ , Unless Otherwise Specified

PARAMETER	SYMBOL	TEST CONDITIONS	MIN	TYP	MAX	UNITS
Drain to Source Breakdown Voltage	$BV_{DSS}$	$I_D = 250\mu\text{A}, V_{GS} = 0\text{V}$	30	-	-	V
Gate to Source Threshold Voltage	$V_{GS(TH)}$	$V_{GS} = V_{DS}, I_D = 250\mu\text{A}$ (Figure 9)	1	-	-	V
Zero Gate Voltage Drain Current	$I_{DSS}$	$V_{DS} = 30\text{V}, V_{GS} = 0\text{V}$	-	-	1	$\mu\text{A}$
		$V_{DS} = 30\text{V}, V_{GS} = 0\text{V}, T_A = 55^\circ\text{C}$	-	-	25	$\mu\text{A}$
Gate to Source Leakage Current	$I_{GSS}$	$V_{GS} = \pm 16\text{V}$	-	-	100	nA
Drain to Source On Resistance	$r_{DS(ON)}$	$I_D = 4.7\text{A}, V_{GS} = 4.5\text{V}$ (Figures 6, 8)	-	0.042	0.055	$\Omega$
		$I_D = 5.8\text{A}, V_{GS} = 10\text{V}$ (Figures 6, 8)	-	0.030	0.037	$\Omega$
Turn-On Delay Time	$t_{d(ON)}$	$V_{DD} = 15\text{V}, I_D \cong 1\text{A},$ $R_L = 15\Omega, V_{GEN} = 10\text{V},$ $R_{GS} = 6\Omega$ (Figures 12, 13)	-	10	16	ns
Rise Time	$t_r$		-	10	16	ns
Turn-Off Delay Time	$t_{d(OFF)}$		-	27	40	ns
Fall Time	$t_f$		-	24	35	ns
Total Gate Charge	$Q_g$	$V_{DS} = 15\text{V}, V_{GS} = 10\text{V}, I_D \cong 5.8\text{A}$ (Figures 14, 15)	-	18	25	nC
Gate to Source Charge	$Q_{gs}$		-	4.5	-	nC
Gate to Drain Charge	$Q_{gd}$		-	2.5	-	nC
Input Capacitance	$C_{ISS}$	$V_{DS} = 25\text{V}, V_{GS} = 0\text{V},$ $f = 1\text{MHz}$ (Figure 4)	-	625	-	pF
Output Capacitance	$C_{OSS}$		-	270	-	pF
Reverse Transfer Capacitance	$C_{RSS}$		-	50	-	pF
Thermal Resistance Junction to Ambient	$R_{\theta JA}$	Pulse Width <10s (Figure 11) Device Mounted on FR-4 Material	-	-	62.5	$^\circ\text{C/W}$

## Source to Drain Diode Specifications

PARAMETER	SYMBOL	TEST CONDITIONS	MIN	TYP	MAX	UNITS
Source to Drain Diode Voltage	$V_{SD}$	$I_{SD} = 1.7\text{A}$ (Figure 7)	-	0.8	1.2	V
Reverse Recovery Time	$t_{rr}$	$I_{SD} = 1.7\text{A}, dI_{SD}/dt = 100\text{A}/\mu\text{s}$	-	45	80	ns

Typical Performance Curves Unless Otherwise Specified

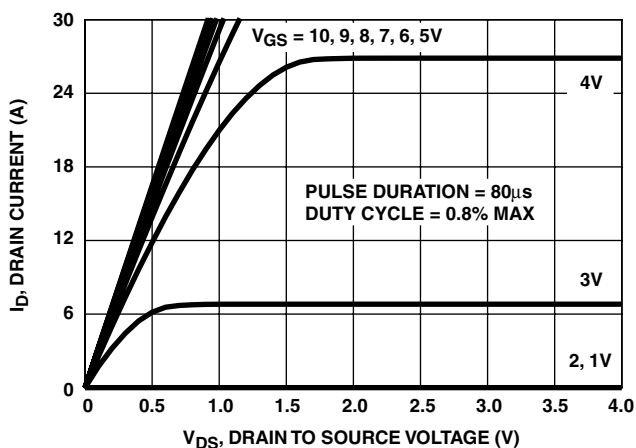

FIGURE 1. OUTPUT CHARACTERISTICS

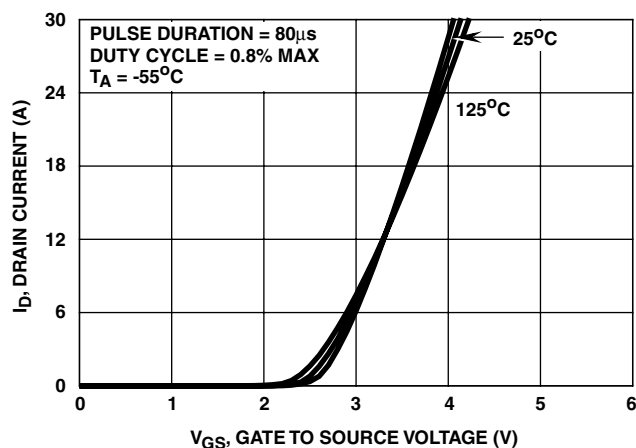

FIGURE 2. TRANSFER CHARACTERISTICS

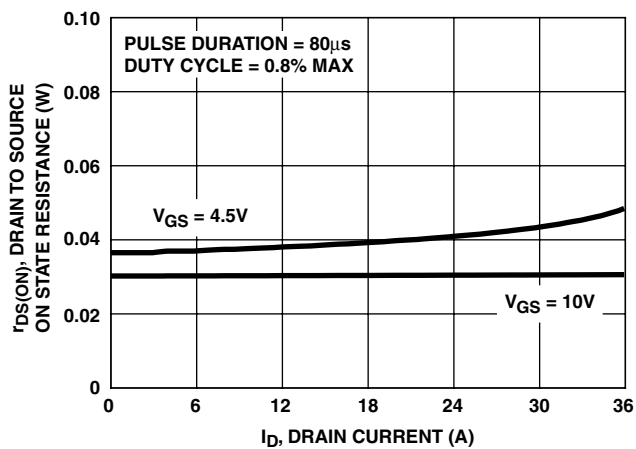

FIGURE 3. DRAIN TO SOURCE ON RESISTANCE vs GATE VOLTAGE AND DRAIN CURRENT

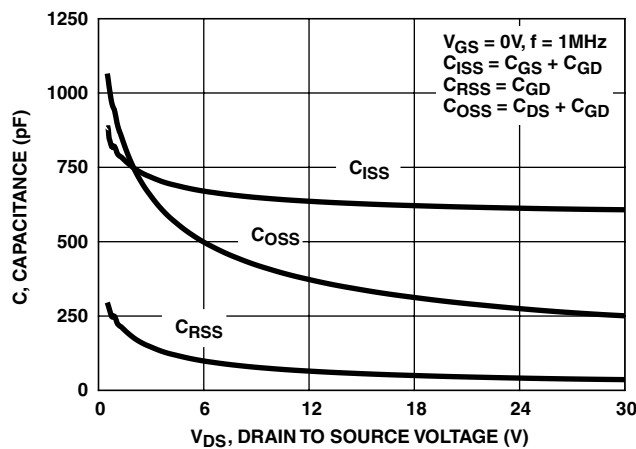

FIGURE 4. CAPACITANCE vs DRAIN TO SOURCE VOLTAGE

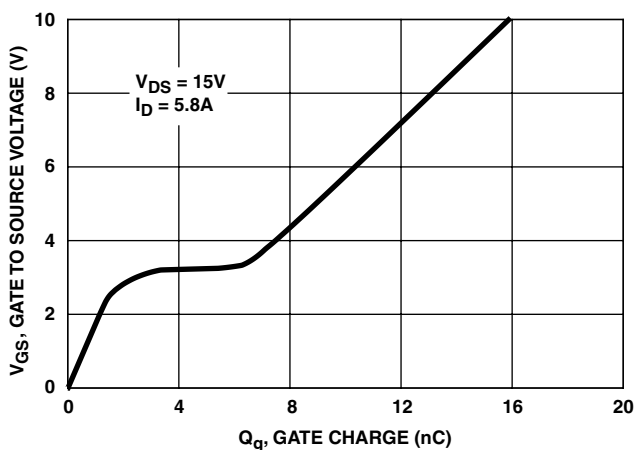

FIGURE 5. GATE TO SOURCE VOLTAGE vs GATE CHARGE

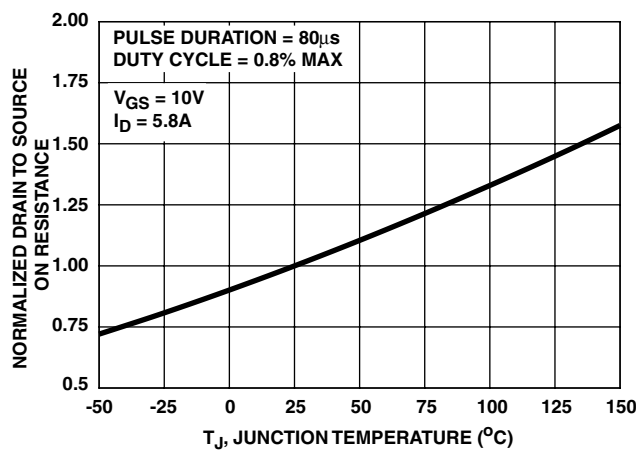

FIGURE 6. NORMALIZED DRAIN TO SOURCE ON RESISTANCE vs JUNCTION TEMPERATURE

Typical Performance Curves Unless Otherwise Specified (Continued)

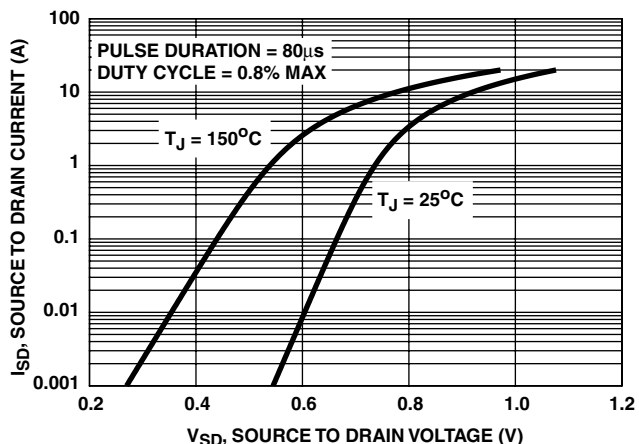

FIGURE 7. SOURCE TO DRAIN DIODE VOLTAGE

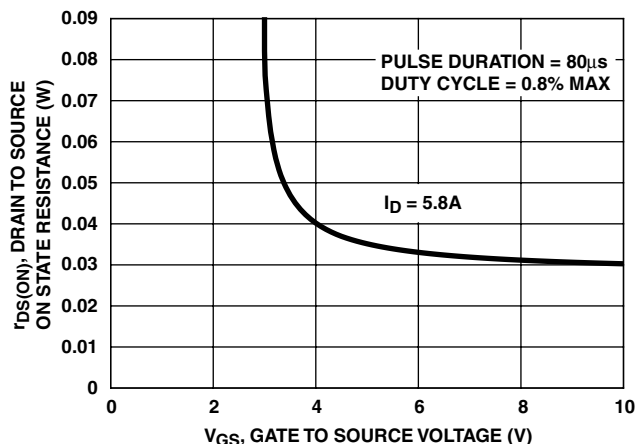

FIGURE 8. DRAIN TO SOURCE ON RESISTANCE vs GATE TO SOURCE VOLTAGE

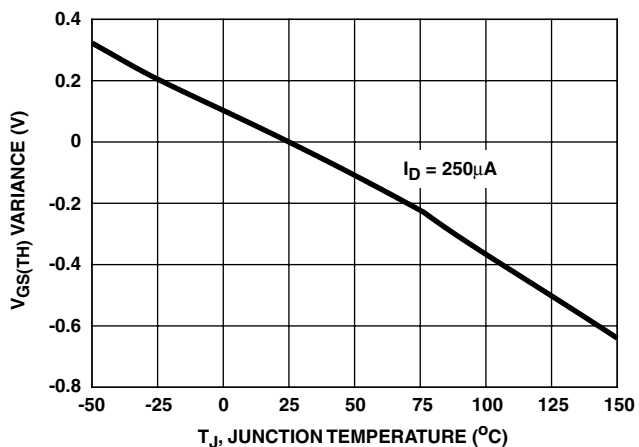

FIGURE 9. GATE THRESHOLD VOLTAGE VARIANCE vs JUNCTION TEMPERATURE

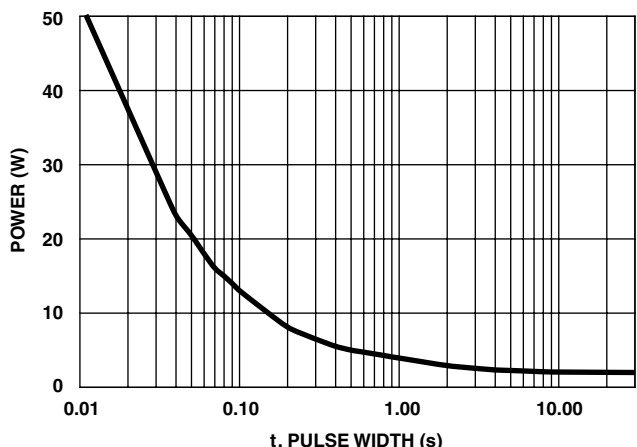

FIGURE 10. SINGLE PULSE POWER CAPABILITY vs PULSE WIDTH

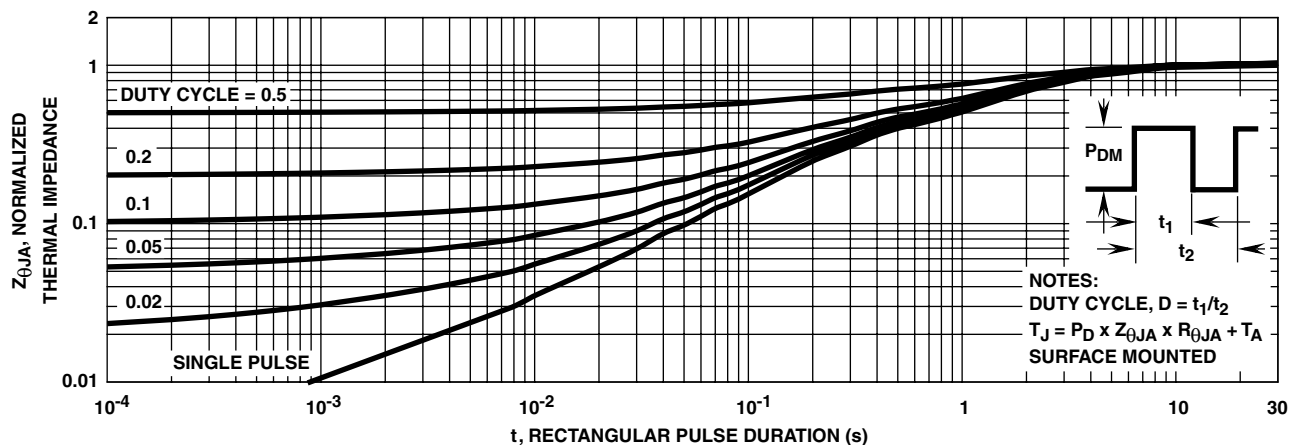

FIGURE 11. NORMALIZED MAXIMUM TRANSIENT THERMAL IMPEDANCE



## TRADEMARKS

The following are registered and unregistered trademarks Fairchild Semiconductor owns or is authorized to use and is not intended to be an exhaustive list of all such trademarks.

ACE <sub>x</sub> <sup>TM</sup>	FAST <sup>®</sup>	OPTOLOGIC <sup>TM</sup>	SMART START <sup>TM</sup>	VCX <sup>TM</sup>
Bottomless <sup>TM</sup>	FAST <sub>r</sub> <sup>TM</sup>	OPTOPLANAR <sup>TM</sup>	STAR*POWER <sup>TM</sup>	
CoolFET <sup>TM</sup>	FRFET <sup>TM</sup>	PACMAN <sup>TM</sup>	Stealth <sup>TM</sup>	
CROSSVOLT <sup>TM</sup>	GlobalOptoisolator <sup>TM</sup>	POP <sup>TM</sup>	SuperSOT <sup>TM</sup> -3	
DenseTrench <sup>TM</sup>	GTO <sup>TM</sup>	Power247 <sup>TM</sup>	SuperSOT <sup>TM</sup> -6	
DOMET <sup>TM</sup>	HiSeC <sup>TM</sup>	PowerTrench <sup>®</sup>	SuperSOT <sup>TM</sup> -8	
EcoSPARK <sup>TM</sup>	ISOPLANAR <sup>TM</sup>	QFET <sup>TM</sup>	SyncFET <sup>TM</sup>	
E <sup>2</sup> CMOS <sup>TM</sup>	LittleFET <sup>TM</sup>	QST <sup>TM</sup>	TinyLogic <sup>TM</sup>	
EnSigna <sup>TM</sup>	MicroFET <sup>TM</sup>	QT Optoelectronics <sup>TM</sup>	TruTranslation <sup>TM</sup>	
FACT <sup>TM</sup>	MicroPak <sup>TM</sup>	Quiet Series <sup>TM</sup>	UHC <sup>TM</sup>	
FACT Quiet Series <sup>TM</sup>	MICROWIRE <sup>TM</sup>	SILENT SWITCHER <sup>®</sup>	UltraFET <sup>®</sup>	

STAR\*POWER is used under license

## DISCLAIMER

FAIRCHILD SEMICONDUCTOR RESERVES THE RIGHT TO MAKE CHANGES WITHOUT FURTHER NOTICE TO ANY PRODUCTS HEREIN TO IMPROVE RELIABILITY, FUNCTION OR DESIGN. FAIRCHILD DOES NOT ASSUME ANY LIABILITY ARISING OUT OF THE APPLICATION OR USE OF ANY PRODUCT OR CIRCUIT DESCRIBED HEREIN; NEITHER DOES IT CONVEY ANY LICENSE UNDER ITS PATENT RIGHTS, NOR THE RIGHTS OF OTHERS.

## LIFE SUPPORT POLICY

FAIRCHILD'S PRODUCTS ARE NOT AUTHORIZED FOR USE AS CRITICAL COMPONENTS IN LIFE SUPPORT DEVICES OR SYSTEMS WITHOUT THE EXPRESS WRITTEN APPROVAL OF FAIRCHILD SEMICONDUCTOR CORPORATION.

As used herein:

1. Life support devices or systems are devices or systems which, (a) are intended for surgical implant into the body, or (b) support or sustain life, or (c) whose failure to perform when properly used in accordance with instructions for use provided in the labeling, can be reasonably expected to result in significant injury to the user.
2. A critical component is any component of a life support device or system whose failure to perform can be reasonably expected to cause the failure of the life support device or system, or to affect its safety or effectiveness.

## PRODUCT STATUS DEFINITIONS

### Definition of Terms

Datasheet Identification	Product Status	Definition
Advance Information	Formative or In Design	This datasheet contains the design specifications for product development. Specifications may change in any manner without notice.
Preliminary	First Production	This datasheet contains preliminary data, and supplementary data will be published at a later date. Fairchild Semiconductor reserves the right to make changes at any time without notice in order to improve design.
No Identification Needed	Full Production	This datasheet contains final specifications. Fairchild Semiconductor reserves the right to make changes at any time without notice in order to improve design.
Obsolete	Not In Production	This datasheet contains specifications on a product that has been discontinued by Fairchild semiconductor. The datasheet is printed for reference information only.