

**Rated voltage 250 Vac**

**Rated current 0,35 to 4,6 A**

**Rated inductance 3,3 to 100 mH**

### Construction

- Current-compensated double choke with closed, rectangular ferrite core
- Closed polycarbonate coil former with 4 sections
- Without encapsulation
- 2-section winding
- Creepage distances and clearances > 3 mm

### Features

- Coil former flame-retardant as per UL 94 V-0
- Recycleable owing to omission of encapsulation and glue
- High resonance frequency due to 2-section winding
- Low leakage due to closed core shape
- High pulse strength
- Low whirring noise
- Approx. 1 % stray inductance for symmetrical interference suppression

### Applications

- Electronic ballasts for lamps
- Switch-mode power supplies for TV sets

### Terminals

- Tinned
- Pins fitting standard PCB grid

### Marking

Ordering code, rated current, rated inductance, mark of conformity, manufacturer, date of manufacture, marking for B82731-H: manufacturer, ordering code

### Approvals

Approval marks	Standards
	EN 60938-2 UL 1283

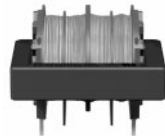

**Dimensional drawings and pin configuration**

Vertical version

Horizontal version

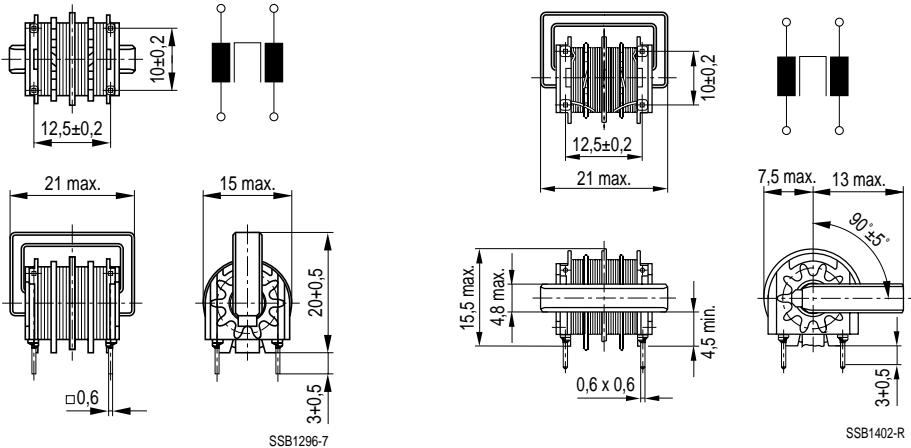
**General technical data**

Rated voltage $V_R$	250 Vac/dc
Test voltage $V_T$	1500 Vac, 2 s (line/line)
Rated current $I_R$	Referred to 50 Hz and 60 °C ambient temperature
Inductance tolerance	- 30/+ 50 %
Weight	Approx. 7 g

 For further technical data [see page 334](#)
**Characteristics and ordering codes**

$I_R$ A	$L_R$ mH	$L_S$ , typ $\mu$ H	$R_{typ}$ m $\Omega$	Ordering code	
				vertical version	horizontal version
0,35	100	1000	4500	B82731-M2351-A30	B82731-H2351-A30
0,4	68	700	3000	B82731-M2401-A33	B82731-H2401-A33
0,5	47	470	2000	B82731-M2501-A30	B82731-H2501-A30
0,6	39	390	1500	B82731-M2601-A30	B82731-H2601-A30
0,7	27	270	1000	B82731-M2701-A30	B82731-H2701-A30
0,9	15	150	600	B82731-M2901-A30	B82731-H2901-A30
1,1	10	100	400	B82731-M2112-A30	B82731-H2112-A30
1,3	6,8	70	280	B82731-M2132-A30	B82731-H2132-A30
1,8	3,3	35	140	B82731-M2182-A30	B82731-H2182-A30

**D Core Chokes**
**Dimensional drawings and pin configuration**

Vertical version

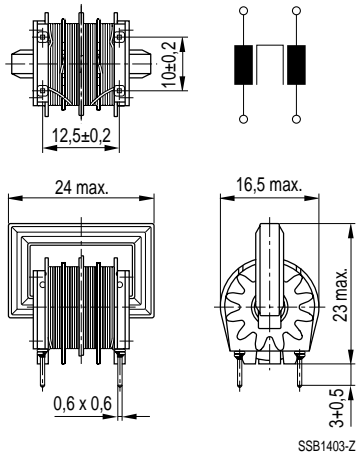

Horizontal version

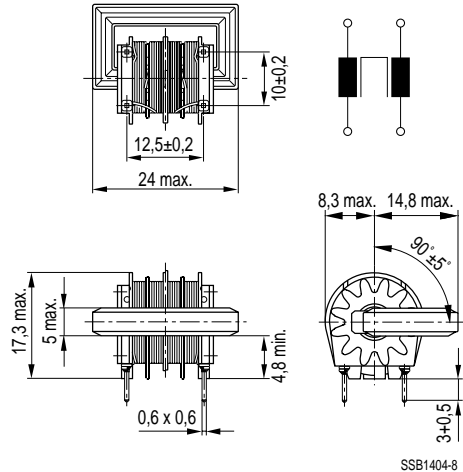
**General technical data**

Rated voltage $V_R$	250 Vac/dc
Test voltage $V_T$	1500 Vac, 2 s (line/line)
Rated current $I_R$	Referred to 50 Hz and 60 °C ambient temperature
Inductance tolerance	- 30/+ 50 %
Weight	Approx. 11 g

 For further technical data [see page 334](#)
**Characteristics and ordering codes**

$I_R$ A	$L_R$ mH	$L_S$ , typ $\mu$ H	$R_{typ}$ m $\Omega$	Ordering code	
				vertical version	horizontal version
0,6	47	400	1400	B82732-R2601-B30	B82732-W2601-B30
0,7	39	330	1100	B82732-R2701-B30	B82732-W2701-B30
0,9	27	230	750	B82732-R2901-B30	B82732-W2901-B30
1,1	15	125	440	B82732-R2112-B30	B82732-W2112-B30
1,4	10	85	300	B82732-R2142-B30	B82732-W2142-B30
1,7	6,8	55	190	B82732-R2172-B30	B82732-W2172-B30
2,2	3,3	27	110	B82732-R2222-B30	B82732-W2222-B30

**D Core Chokes**
**Dimensional drawings and pin configuration**

Vertical version

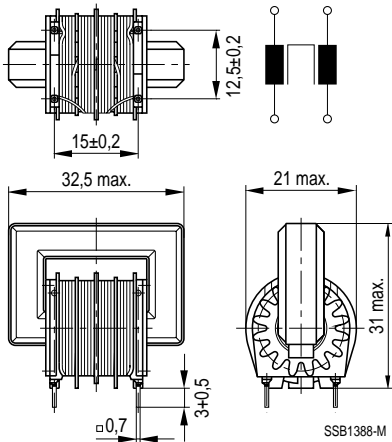

Horizontal version

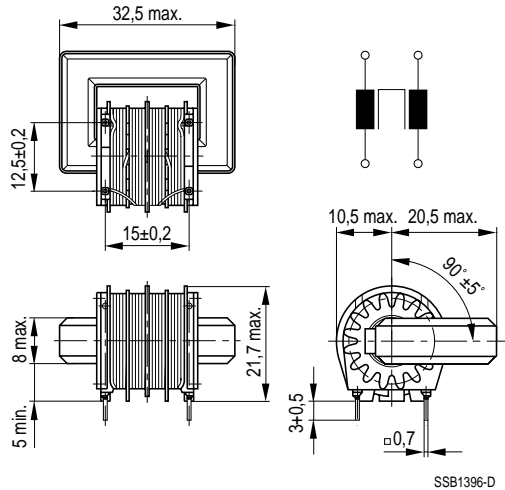
**General technical data**

Rated voltage $V_R$	250 Vac/dc
Test voltage $V_T$	1500 Vac, 2 s (line/line)
Rated current $I_R$	Referred to 50 Hz and 60 °C ambient temperature
Inductance tolerance	- 30/+ 50 %
Weight	Approx. 30 g

 For further technical data [see page 334](#)
**Characteristics and ordering codes**

$I_R$ A	$L_R$ mH	$L_S$ , typ $\mu$ H	$R_{typ}$ m $\Omega$	Ordering code	
				vertical version	horizontal version
1,3	47	250	560	B82734-R2132-B30	B82734-W2132-B30
1,4	39	210	460	B82734-R2142-B30	B82734-W2142-B30
1,7	27	140	320	B82734-R2172-B30	B82734-W2172-B30
2,3	15	80	185	B82734-R2232-B30	B82734-W2232-B30
2,6	10	53	130	B82734-R2262-B30	B82734-W2262-B30
3,2	6,8	35	85	B82734-R2322-B30	B82734-W2322-B30
4,6	3,3	17	46	B82734-R2462-B30	B82734-W2462-B30

**Impedance  $|Z|$  versus frequency  $f$**   
(measured with windings in parallel)

B82731-\*

\* = M or H

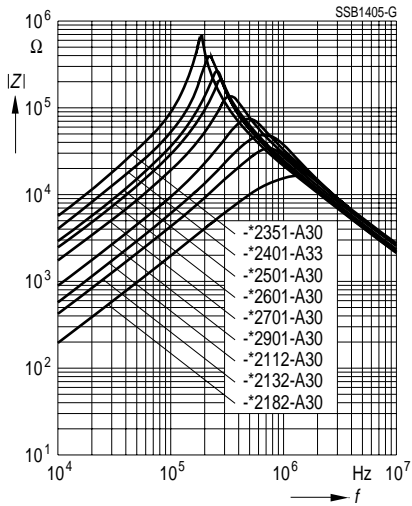

B82732-\*

\* = R or W

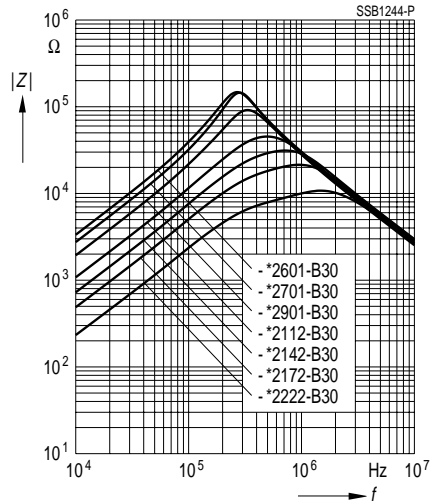

B82734-\*

\* = R or W

