

### Features

- Epitaxial Planar Die Construction
- Complementary NPN Types Available (DDTC)
- Built-In Biasing Resistors, R1 = R2

### Mechanical Data

- Case: SOT-323, Molded Plastic
- Case material - UL Flammability Rating 94V-0
- Moisture sensitivity: Level 1 per J-STD-020A
- Terminals: Solderable per MIL-STD-202, Method 208
- Terminal Connections: See Diagram
- Marking: Date Code and Marking Code (See Diagrams & Page 2)
- Weight: 0.006 grams (approx.)
- Ordering Information (See Page 2)

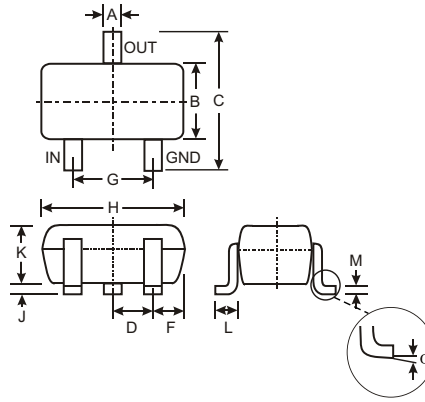

SOT-323		
Dim	Min	Max
A	0.25	0.40
B	1.15	1.35
C	2.00	2.20
D	0.65 Nominal	
E	0.30	0.40
G	1.20	1.40
H	1.80	2.20
J	0.0	0.10
K	0.90	1.00
L	0.25	0.40
M	0.10	0.18
	0	8
All Dimensions in mm		

P/N	R1, R2 (NOM)	MARKING
DDTA123EUA	2.2K	P04
DDTA143EUA	4.7K	P08
DDTA114EUA	10K	P13
DDTA124EUA	22K	P17
DDTA144EUA	47K	P20
DDTA115EUA	100K	P24

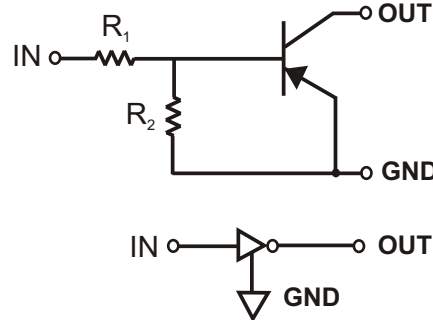

SCHEMATIC DIAGRAM

### Maximum Ratings @ T<sub>A</sub> = 25 C unless otherwise specified

Characteristic	Symbol	Value	Unit
Supply Voltage, (3) to (1)	V <sub>CC</sub>	-50	V
Input Voltage, (2) to (1)	V <sub>IN</sub>	+10 to -12 +10 to -30 +10 to -40 +10 to -40 +10 to -40 +10 to -40 +10 to -40	V
Output Current	I <sub>O</sub>	-100 -100 -50 -30 -30 -20	mA
Output Current	I <sub>C</sub> (Max)	-100	mA
Power Dissipation	P <sub>d</sub>	200	mW
Thermal Resistance, Junction to Ambient Air (Note 1)	R <sub>JA</sub>	625	C/W
Operating and Storage and Temperature Range	T <sub>j</sub> , T <sub>STG</sub>	-55 to +150	C

Note: 1. Mounted on FR4 PC Board with recommended pad layout at <http://www.diodes.com/datasheets/ap02001.pdf>.

**Electrical Characteristics** @ T<sub>A</sub> = 25 C unless otherwise specified

Characteristic		Symbol	Min	Typ	Max	Unit	Test Condition
Input Voltage		V <sub>I(off)</sub>	-0.5	-1.1		V	V <sub>CC</sub> = 5V, I <sub>O</sub> = 100 A
		V <sub>I(on)</sub>		-1.9	-3		V <sub>O</sub> = 0.3V, I <sub>O</sub> = 20mA, DDTA123EUA V <sub>O</sub> = 0.3V, I <sub>O</sub> = 20mA, DDTA143EUA V <sub>O</sub> = 0.3V, I <sub>O</sub> = 10mA, DDTA114EUA V <sub>O</sub> = 0.3V, I <sub>O</sub> = 5mA, DDTA124EUA V <sub>O</sub> = 0.3V, I <sub>O</sub> = 2mA, DDTA144EUA V <sub>O</sub> = 0.3V, I <sub>O</sub> = 1mA, DDTA115EUA
Output Voltage		V <sub>O(on)</sub>		-0.1	-0.3	V	I <sub>O</sub> /I <sub>I</sub> = 10mA/0.5mA, DDTA123EUA I <sub>O</sub> /I <sub>I</sub> = 10mA/0.5mA, DDTA143EUA I <sub>O</sub> /I <sub>I</sub> = 10mA/0.5mA, DDTA114EUA I <sub>O</sub> /I <sub>I</sub> = 10mA/0.5mA, DDTA124EUA I <sub>O</sub> /I <sub>I</sub> = 10mA/0.5mA, DDTA144EUA I <sub>O</sub> /I <sub>I</sub> = 5mA/0.25mA, DDTA115EUA
Input Current	DDTA123EUA DDTA143EUA DDTA114EUA DDTA124EUA DDTA144EUA DDTA115EUA	I <sub>I</sub>			-3.8 -1.8 -0.88 -0.36 -0.18 -0.15	mA	V <sub>I</sub> = -5V
Output Current		I <sub>O(off)</sub>			0.5	A	V <sub>CC</sub> = -50V, V <sub>I</sub> = 0V
DC Current Gain	DDTA123EUA DDTA143EUA DDTA114EUA DDTA124EUA DDTA144EUA DDTA115EUA	G <sub>I</sub>	-20 -20 -30 -56 -68 -82				V <sub>O</sub> = -5V, I <sub>O</sub> = -20mA V <sub>O</sub> = -5V, I <sub>O</sub> = -10mA V <sub>O</sub> = -5V, I <sub>O</sub> = -5mA V <sub>O</sub> = -5V, I <sub>O</sub> = -5mA V <sub>O</sub> = -5V, I <sub>O</sub> = -5mA V <sub>O</sub> = -5V, I <sub>O</sub> = -5mA
Input Resistor (R <sub>1</sub> ) Tolerance		DR <sub>1</sub>	-30		+30	%	
Resistance Ratio		R <sub>2</sub> /R <sub>1</sub>	0.8	1	1.2		
Gain-Bandwidth Product*		f <sub>T</sub>		250		MHz	V <sub>CE</sub> = -10V, I <sub>E</sub> = 5mA, f = 100MHz

\* Transistor - For Reference Only

**Ordering Information** (Note 2)

Device	Packaging	Shipping
DDTA123EUA-7	SOT-323	3000/Tape & Reel
DDTA143EUA-7	SOT-323	3000/Tape & Reel
DDTA114EUA-7	SOT-323	3000/Tape & Reel
DDTA124EUA-7	SOT-323	3000/Tape & Reel
DDTA144EUA-7	SOT-323	3000/Tape & Reel
DDTA115EUA-7	SOT-323	3000/Tape & Reel

Notes: 2. For Packaging Details, go to our website at <http://www.diodes.com/datasheets/ap02007.pdf>.

**Marking Information**

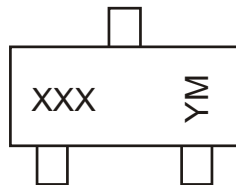

XXX = Product Type Marking Code  
See Sheet 1 Diagrams  
YM = Date Code Marking  
Y = Year ex: N = 2002  
M = Month ex: 9 = September

Date Code Key

Year	2002	2003	2004	2005	2006	2007	2008	2009
Code	N	P	R	S	T	U	V	W

Month	Jan	Feb	March	Apr	May	Jun	Jul	Aug	Sep	Oct	Nov	Dec
Code	1	2	3	4	5	6	7	8	9	O	N	D

TYPICAL CURVES - DDTA143EUA

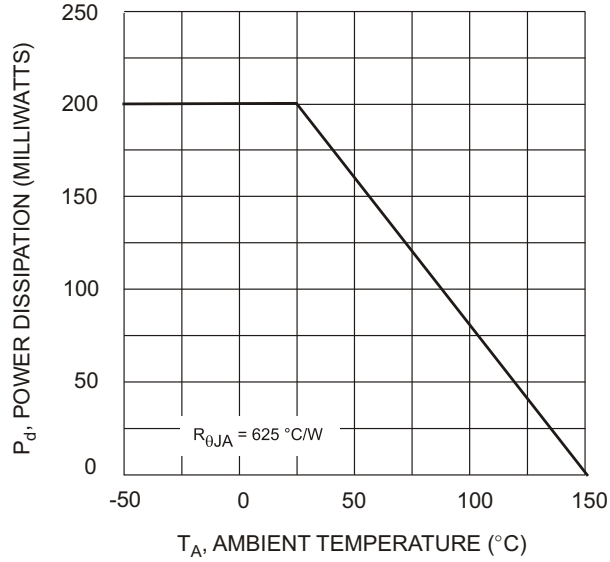

Fig. 1 Derating Curve

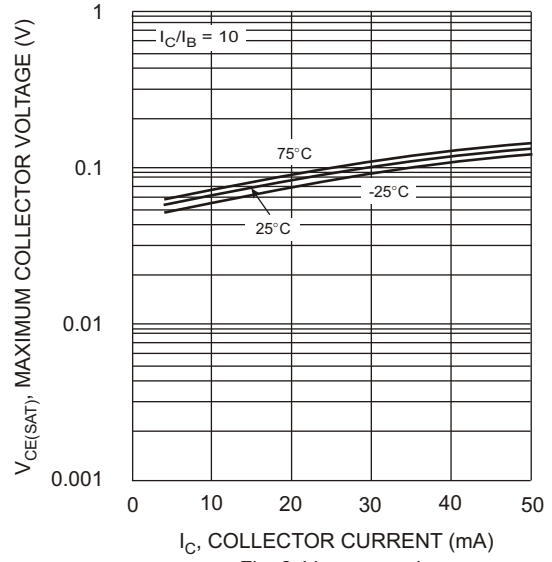

Fig. 2  $V_{CE(SAT)}$  vs.  $I_C$

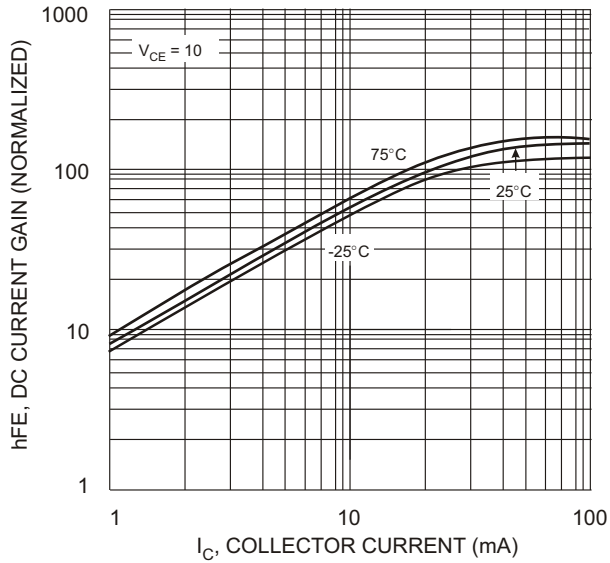

Fig. 3 DC CURRENT GAIN

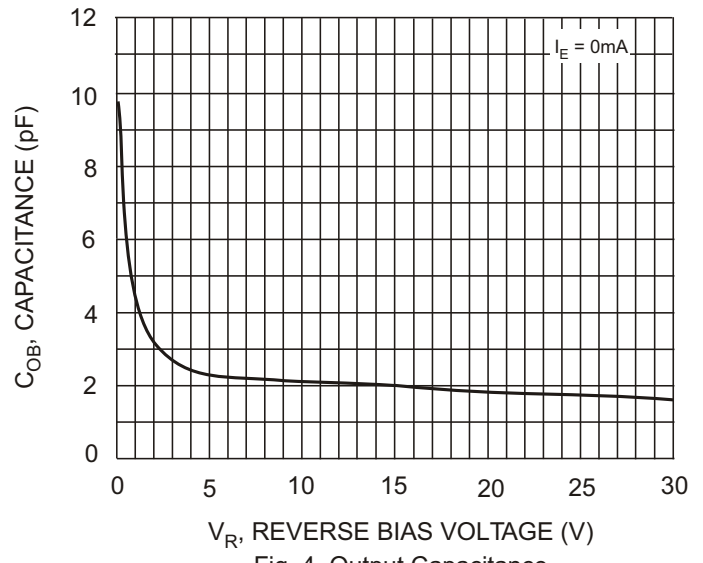

Fig. 4 Output Capacitance

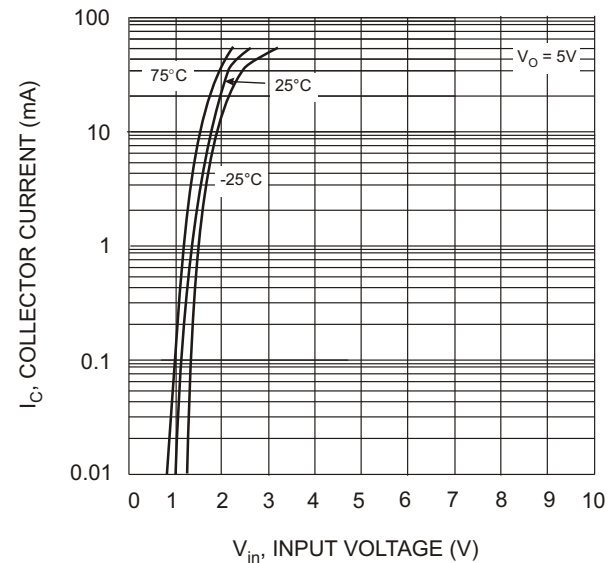

Fig. 5 Collector Current Vs. Input Voltage

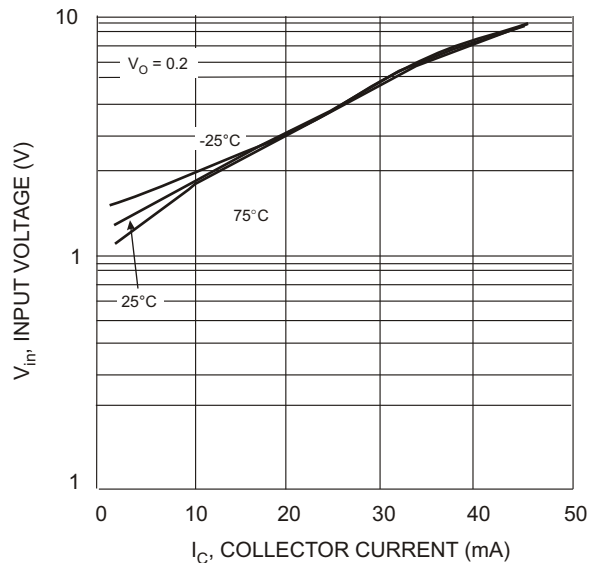

Fig. 6 Input Voltage vs. Collector Current