



DC COMPONENTS CO., LTD.

RECTIFIER SPECIALISTS

**FSM101
THRU
FSM107**

TECHNICAL SPECIFICATIONS OF SURFACE MOUNT FAST RECOVERY RECTIFIER

VOLTAGE RANGE - 50 to 1000 Volts

CURRENT - 1.0 Ampere

FEATURES

- * Ideal for surface mounted applications
- * Low leakage current
- * Fast switching for high efficiency
- * Glass passivated junction

MECHANICAL DATA

- * Case: Molded plastic
- * Epoxy: UL 94V-0 rate flame retardant
- * Terminals: Solder plated solderable per MIL-STD-202E, Method 208 guaranteed
- * Polarity: Color band denotes cathode end
- * Mounting position: Any
- * Weight: 0.12 gram

MAXIMUM RATINGS AND ELECTRICAL CHARACTERISTICS

Ratings at 25 °C ambient temperature unless otherwise specified.
Single phase, half wave, 60 Hz, resistive or inductive load.
For capacitive load, derate current by 20%.



SM-1(DO-213AB)

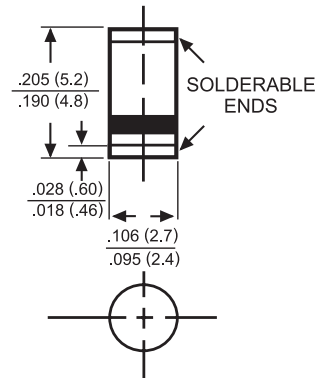

Dimensions in inches and (millimeters)

	SYMBOL	FSM101	FSM102	FSM103	FSM104	FSM105	FSM106	FSM107	UNITS	
Maximum Recurrent Peak Reverse Voltage	V _{RRM}	50	100	200	400	600	800	1000	Volts	
Maximum RMS Voltage	V _{RMS}	35	70	140	280	420	560	700	Volts	
Maximum DC Blocking Voltage	V _{DC}	50	100	200	400	600	800	1000	Volts	
Maximum Average Forward Rectified Current at T _A = 55°C	I _O	1.0							Amps	
Peak Forward Surge Current 8.3 ms single half sine-wave superimposed on rated load (JEDEC Method)	I _{FSM}	30							Amps	
Maximum Forward Voltage at 1.0A DC	V _F	1.3							Volts	
Maximum DC Reverse Current at Rated DC Blocking Voltage	I _R	@ T _A = 25°C	5.0							uAmps
		@ T _A = 125°C	100							
Maximum Reverse Recovery Time (Note 3)	t _{rr}	150				250	500		nSec	
Maximum Thermal Resistance (Note 2)	R _{θJL}	30							°C/W	
Typical Junction Capacitance (Note 1)	C _J	15							pF	
Operating and Storage Temperature Range	T _J , T _{STG}	-65 to + 175							°C	

NOTES : 1. Measured at 1.0 MHz and applied reverse voltage of 4.0VDC
 2. Thermal resistance (Junction to Ambient), .24in² (6.0mm²)copper pads to each terminal.
 3. Test Conditions: I_F = 0.5A, I_R = 1.0A, I_{RR} = 0.25A

RATING AND CHARACTERISTIC CURVES (FSM101 THRU FSM107)

FIG. 1 - TYPICAL FORWARD CURRENT DERATING CURVE

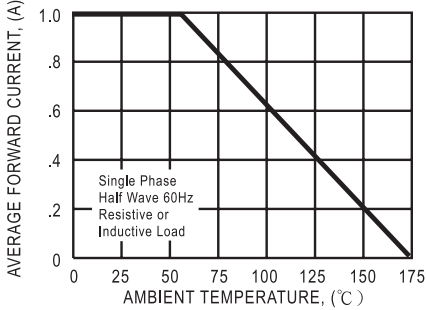

FIG. 2 - MAXIMUM NON-REPETITIVE FORWARD SURGE CURRENT

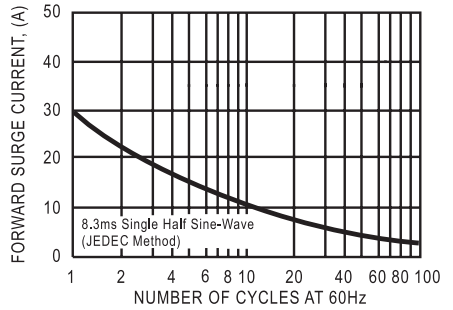

FIG. 3 - TYPICAL REVERSE CHARACTERISTICS

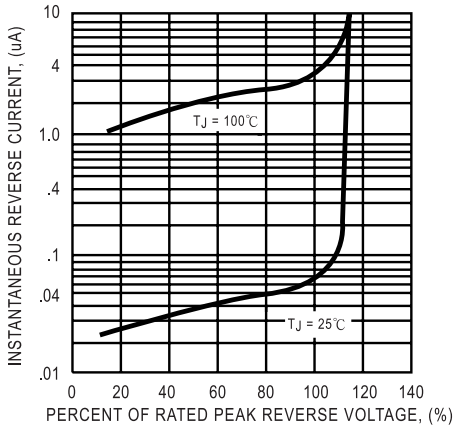

FIG. 4 - TYPICAL INSTANTANEOUS FORWARD CHARACTERISTICS

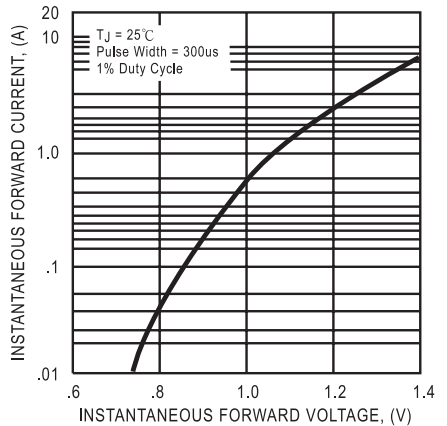
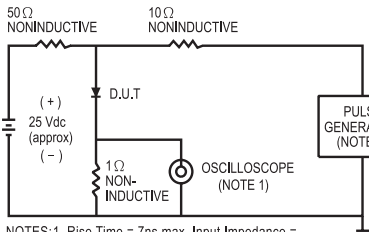

FIG. 5 - TEST CIRCUIT DIAGRAM AND REVERSE RECOVERY TIME CHARACTERISTIC



NOTES: 1. Rise Time = 7ns max. Input Impedance = 1 megohm, 22 pF.
 2. Rise Time = 10ns max. Source Impedance = 50 ohms.

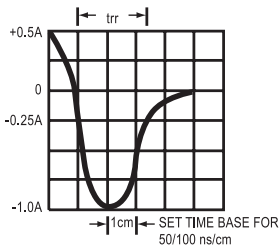
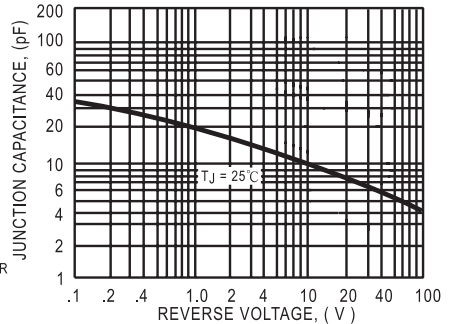

FIG. 6 - TYPICAL JUNCTION CAPACITANCE



DC COMPONENTS CO., LTD.