



**DC COMPONENTS CO., LTD.**

RECTIFIER SPECIALISTS

**ES1A  
THRU  
ES1G**

**TECHNICAL SPECIFICATIONS OF SURFACE MOUNT SUPER FAST RECTIFIER**

**VOLTAGE RANGE - 50 to 400 Volts**

**CURRENT - 1.0 Ampere**

**FEATURES**

- \* Ideal for surface mounted applications
- \* Low leakage current
- \* Glass passivated junction

**MECHANICAL DATA**

- \* Case: Molded plastic
- \* Epoxy: UL 94V-0 rate flame retardant
- \* Terminals: Solder plated solderable per MIL-STD-750, Method 2026
- \* Polarity: As marked
- \* Mounting position: Any
- \* Weight: 0.064 gram

**MAXIMUM RATINGS AND ELECTRICAL CHARACTERISTICS**

Ratings at 25 °C ambient temperature unless otherwise specified.  
Single phase, half wave, 60 Hz, resistive or inductive load.  
For capacitive load, derate current by 20%.



**SMA ( DO-214AC)**

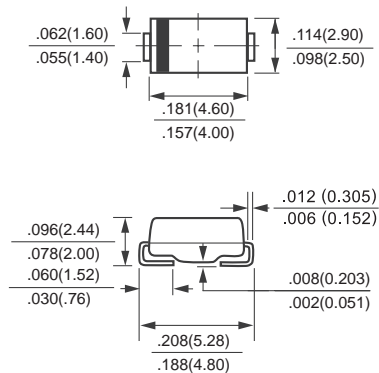

Dimensions in inches and (millimeters)

	SYMBOL	ES1A	ES1B	ES1C	ES1D	ES1E	ES1G	UNITS
Maximum Recurrent Peak Reverse Voltage	V <sub>RRM</sub>	50	100	150	200	300	400	Volts
Maximum RMS Volts	V <sub>RMS</sub>	35	70	105	140	210	280	Volts
Maximum DC Blocking Voltage	V <sub>DC</sub>	50	100	150	200	300	400	Volts
Maximum Average Forward Current at TA = 55°C	I <sub>O</sub>	1.0						Amps
Peak Forward Surge Current IFM (surge): 8.3 ms single half sine-wave superimposed on rated load (JEDEC Method)	I <sub>FSM</sub>	30						Amps
Maximum Forward Voltage at 1.0A DC	V <sub>F</sub>	0.95				1.25		Volts
Maximum DC Reverse Current at Rated DC Blocking Voltage	I <sub>R</sub>	@ TA = 25°C		5.0				uAmps
		@ TA = 100°C		100				
Maximum Reverse Recovery Time (Note 1)	t <sub>rr</sub>	35						nSec
Typical Junction Capacitance (Note 2)	C <sub>J</sub>	15				10		pF
Operating and Storage Temperature Range	T <sub>J</sub> , T <sub>STG</sub>	-65 to + 175						°C

NOTES : 1. Test Conditions: I<sub>F</sub>=0.5A, I<sub>R</sub>=1.0A, I<sub>RR</sub>=0.25A.  
2. Measured at 1 MHz and applied reverse voltage of 4.0 volts.

# RATING AND CHARACTERISTIC CURVES (ES1A THRU ES1G)

FIG. 1 - TEST CIRCUIT DIAGRAM AND REVERSE RECOVERY TIME CHARACTERISTIC

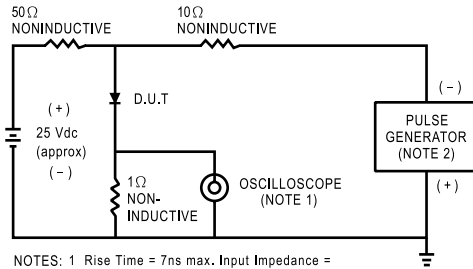

NOTES: 1 Rise Time = 7ns max. Input Impedance = 1 megohm, 22 pF.  
2. Rise Time = 10ns max. Source Impedance = 50 ohms.

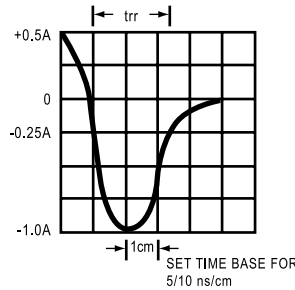

FIG. 2 - TYPICAL FORWARD CURRENT DERATING CURVE

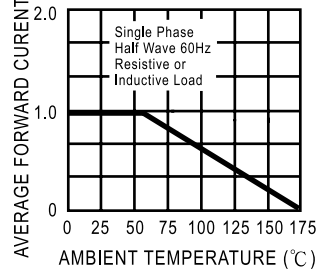

FIG. 3 - TYPICAL REVERSE CHARACTERISTICS

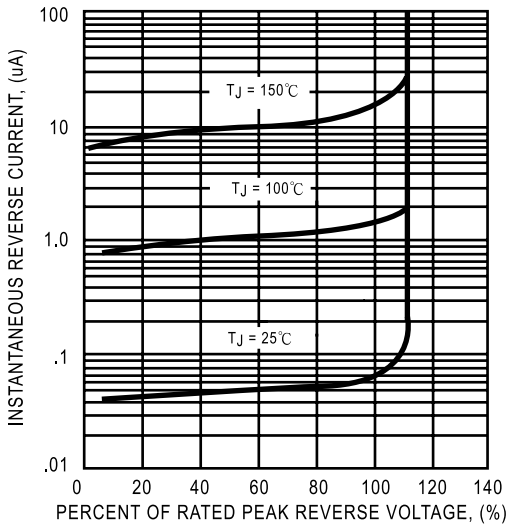

FIG. 4 - TYPICAL INSTANTANEOUS FORWARD CHARACTERISTICS

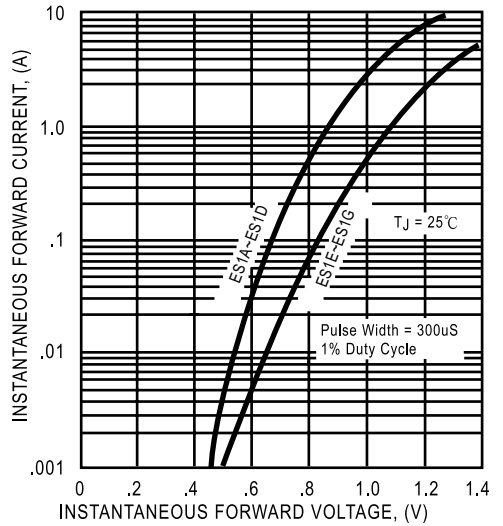

FIG. 5 - MAXIMUM NON-REPETITIVE FORWARD SURGE CURRENT

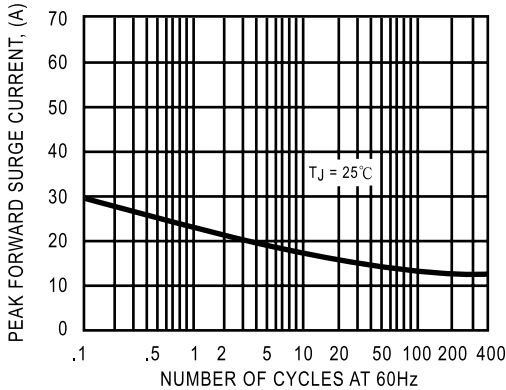
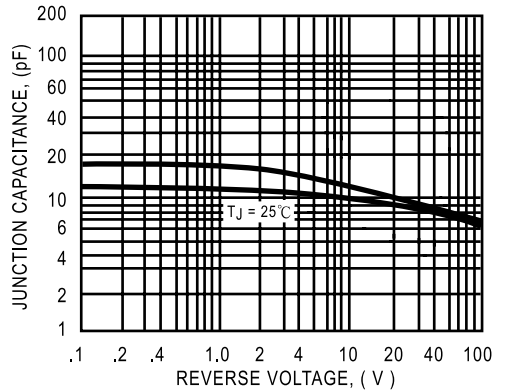

FIG. 6 - TYPICAL JUNCTION CAPACITANCE



DC COMPONENTS CO., LTD.